



THE FILLER METAL SPECIALIST



Certilas is aiming for quality improvement every day with its CEWELD® products, with the most modern Manufacturing facilities around de globe CEWELD® products are proven to be the best available filler metals and are chosen independently to guarantee the highest quality available.

We offer a huge variety of welding, brazing and metal spray consumables including very modern test facilities, a modern automated warehouse, batch registration with full traceability and the ability to deliver all filler metals with a certificate of quality. According EN 10204. All our consumables fully comply with the EN ISO and AWS standards.

Under de CEWELD® brand you'll find world's widest selection of welding consumables for the welding industry. We carry a huge stock of MIG-MAG welding wires, SAW wires, cored wires, Tig rods, electrodes, silver brazing rods, spray powders and spray wires for steel, stainless steel, aluminum, copper, nickel, Inconel, Monel, Brightray, Nilo, Nimonic, Hasteloy, Stellite, Titanium, CuNiFer and many other alloys.

The Certilas Team behind the CEWELD® products is at your service day and night, we offer metallurgical support on the highest possible level and are glad to share our experience in many fields such as oil and gas, offshore, railway, pipeline, hardfacing, nickel alloys, high tensile steels, sub arc solutions and much more. We pride ourselves on the quality of our goods and the reliability of our delivery system. CEWELD® products are found in more than 60 countries worldwide.

**OUR GOAL OUR VISION**

**CONSTANT STRIVE TO BE THE BEST,  
NOT THE BIGGEST!**

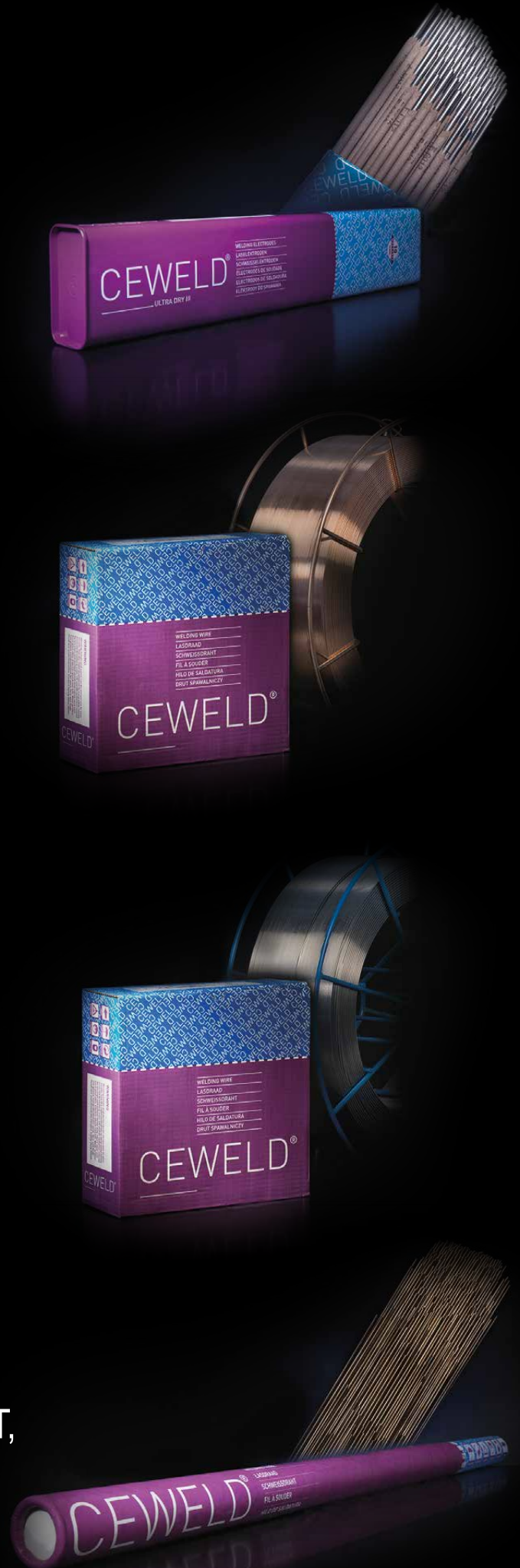

# Welding Consumables Edition 2023

## Certilas is standing for high quality Products

A better quality is what CEWELD<sup>®</sup> stands for and this has been the main driver behind our spectacular growth. CE marking gives you the warranty that the goods are delivered within a traceability and quality system that is witnessed by a notified body and confirms that it complies to the latest European standards (EN ISO 13479). The unique CPD / CPR number enables the notified bodies to trace the final manufacturing unit of the product to make sure that the whole supply chain is controlled and fulfills the latest EN ISO rules.



**Disclaimer:** Whilst all reasonable efforts have been made to ensure the accuracy of the information contained, the information contained or otherwise referenced herein is presented only as “typical” without guarantee or warranty, and any liability incurred from any reliance thereon is expressly disclaimed. Typical data are those obtained when welded and tested in accordance to prescribed standards, and should not be assumed to be the expected results in a particular application or weldment. Other tests and procedures may produce different results. Users are cautioned to confirm by qualification testing, or other appropriate means, the suitability of any welding consumable and procedure before use in the intended application. The selection and use of specific products is solely within the control of, and remains the sole responsibility of the customer. The right to change design and/or specifications without notice is reserved.



**NOTE ON THE USE OF THIS DIGITAL VERSION OF THE CATALOG:**

**Please be aware that our catalog contains hyperlinks in the overviews, these are intended to facilitate your work with this digital version.**

**With the FREE SEARCH function, you can search the entire document for materials, material numbers, standards, terms...**

1 - STICK ELECTRODES

1

2 - CORED WIRES

2

3 - SOLID WIRES

3

4 - SAW (WIRE AND FLUX)

4

5 - BRAZING

5

6 - THERMAL SPRAY

6

7 - WELDING KNOW-HOW

7

[CLICK HERE FOR EXTENDED SEARCH](#)

SEARCH





# 1 - STICK ELECTRODES



# 1 STICK ELECTRODES

Nr.	Group	Page
0	OVERVIEW OF THE PRODUCTS	1/3-5
<b>STICK ELECTRODES FOR JOINT WELDING</b>		
1	CELLULOSIC FOR NON - AND LOW - ALLOY STEEL	1/6
2	RUTILE FOR NON - AND LOW - ALLOY STEEL	1/6
3	BASIC FOR NON - AND LOW - ALLOY STEEL	1/7
4	FOR CREEP RESISTING STEEL	1/7
5	FOR WEATHER RESISTANT STEEL	1/7
6	FOR HIGH- STRENGTH LOW ALLOY AND FINE GRAIN STEEL	1/8
7	FOR STAINLESS CRNI STEEL	1/8
8	FOR STAINLESS CRNIMO STEEL	1/9
9	FOR HEAT-RESISTANT STAINLESS STEEL	1/10
10	FOR DIFFICULT TO WELD STEEL	1/11
11	FOR NICKEL BASED ALLOY	1/12-13
<b>STICK ELECTRODES FOR HARDFACING</b>		
12	FOR SHOCK AND ABRASION RESISTANCE	1/14
13	FOR HIGH WEAR RESISTANCE	1/14-15
14	FOR FERRITIC AND MARTENSITIC STAINLESS STEEL	1/15
15	STELLITE ALLOY ( COBALT BASED )	1/16
16	FOR CUTTING EDGES AND TOOL STEEL	1/16
17	MANGANESE BASED ALLOYS	1/16
18	TUNGSTEN CARBIDE ALLOYS	1/17
<b>STICK ELECTRODES FOR SPECIAL APPLICATIONS</b>		
19	FOR ALUMINIUM AND ALUMINIUM ALLOYS	1/17
20	FOR ALUMINIUM BRONZE	1/17
21	FOR TIN BRONZE	1/18
22	FOR COPPER BASE	1/18
23	FOR CAST IRON	1/18
24	FOR GOUGING AND CUTTING	1/19
25	FOR UNDER WATER (WET) WELDING	1/19

CLICK HERE FOR EXTENDED SEARCH

SEARCH

**Disclaimer:** Whilst all reasonable efforts have been made to ensure the accuracy of the information contained, the information contained or otherwise referenced herein is presented only as "typical" without guarantee or warranty, and any liability incurred from any reliance thereon is expressly disclaimed. Typical data are those obtained when welded and tested in accordance to prescribed standards, and should not be assumed to be the expected results in a particular application or weldment. Other tests and procedures may produce different results. Users are cautioned to confirm by qualification testing, or other appropriate means, the suitability of any welding consumable and procedure before use in the intended application. The selection and use of specific products is solely within the control of, and remains the sole responsibility of the customer. The right to change design and/or specifications without notice is reserved.

Certilas Nederland B.V. | Gloxinialaan 2, 6851 TG Huissen, The Netherlands | [info@certilas.com](mailto:info@certilas.com) | [www.certilas.com](http://www.certilas.com) | Rev.2023.



# Overview - STICK ELECTRODES 1

No.	Product Name	ISO	ASME	FM Group	F-Number:	Page
<b>1. CELLULOSIC NON- AND LOW - ALLOY STEEL</b>						
1	CEWELD E 6010	2560-A: E 38 3 C 21	A 5.1: E 6010	FM1	F-No. 3	1/6
2	CEWELD E 7010	2560-A: E 42 3 C 25	A 5.5: E 7010-P1	FM1	F-No. 3	1/6
<b>2. RUTILE NON- AND LOW-ALLOY STEEL</b>						
3	CEWELD E 6013 Root	2560-A: E 38 2 RB 12	A 5.1: E 6013	FM1	F-No. 2	1/6
4	CEWELD E 6013 S	2560-A: E 38 0 RC 11	A 5.1: E 6012	FM1	F-No. 2	1/6
5	CEWELD E 6013 Fall	2560-A: E 38 0 RC 11	A 5.1: E 6013	FM1	F-No. 2	1/6
6	CEWELD E 6013 T	2560-A: E 42 0 RR 12	A 5.1: E 6013	FM1	F-No. 2	1/6
7	CEWELD E 1000 S	2560-A: E 42 0 RC 11	A 5.1: E 6013	FM1	F-No. 1	1/6
8	CEWELD E 7024(150)	2560-A: E 38 0 RR 53	A 5.1: E 7024	FM1	F-No. 1	1/6
9	CEWELD E 7024(150)	2560-A: E 42 0 RR 74	A 5.1: E 7024	FM1	F-No. 1	1/6
10	CEWELD E 7024(200)	2560-A: E 42 0 RR 74	A 5.1: E 7024	FM1	F-No. 1	1/6
11	CEWELD E 7027	2560-A: E 42 4 RA 53	A 5.1: E 7027	FM1	F-No. 1	1/6
<b>3. BASIC ELECTRODES FOR NON- AND LOW- ALLOY STEEL</b>						
12	CEWELD E 6018 LC	2560-A: E 35 4 B 32 H5	A 5.1: E 6018-1	FM1	F-No. 4	1/7
13	CEWELD E 7016	2560-A: E 42 4 B 12 H10	A 5.1: E 7016	FM1	F-No. 4	1/7
14	CEWELD E 7018-1	2560-A: E 42 4 B 32 H5	A 5.1: E 7018-1 (H4R)	FM1	F-No. 4	1/7
<b>4. FOR CREEP RESISTING STEEL</b>						
15	CEWELD E 7018-A1	3580-A: E Mo B 42 H5	A 5.5: E 7018-A1	FM3	F-No. 4	1/7
16	CEWELD E 8018-B2	3580-A: E CrMo1 B 42 H5	A 5.5: E 8018-B2	FM3	F-No. 4	1/7
17	CEWELD E 9018-B3	3580-A: E CrMo2 B 42 H5	A 5.5: E 9018-B3 (H4R)	FM3	F-No. 4	1/7
18	CEWELD E 9018-B9	3580-A: E CrMo91 B42 H5	A 5.5: E 9018-B9	FM3	F-No. 4	1/7
<b>5. FOR WEATHER RESISTANT STEEL</b>						
19	CEWELD E Corten	2560-A: E 46 4 ZB 42 H5	A 5.5: E 7018-G	FM1	F-No. 4	1/7
<b>6. FOR HIGH - STRENGHT LOW ALLOY AND FINE GRAIN STEEL</b>						
20	CEWELD E 8018-C1	2560-A: E 50 8 2Ni B 42 H5	A 5.5: E 8018-C1	FM1	F-No. 4	1/8
21	CEWELD E 8018-C2	2560-A: E 46 8 3Ni B 32 H5	A 5.5: E 8018-C2	FM1	F-No. 4	1/8
22	CEWELD E 8018-C3	2560-A: E 50 6 1Ni B 42 H5	A 5.5: E 8018-C3	FM1	F-No. 4	1/8
23	CEWELD E 9018-G	18275-A: E 55 6 Mn1NiMo B 42 H5	A 5.5: E 9018-G	FM2	F-No. 4	1/8
24	CEWELD E 10018-D2	18275-A: E 62 4 MnMo B 42 H5	A 5.5: -E 10018-D2	FM2	F-No. 4	1/8
25	CEWELD E 10018-G	18275-A: E 62 6 Mn2NiCrMo B 42 H5	A 5.5: E 10018-G	FM2	F-No. 4	1/8
26	CEWELD E 11018-H	18275-A: E 69 6 Mn2NiCrMo B 42 H5	A 5.5: E 11018-M	FM2	F-No. 4	1/8
27	CEWELD E 12018-Mo	18275-A: E 89 4 ZB62 H5	A 5.5: E 12018-G	FM2	F-No. 4	1/8
<b>7. FOR CRNI STAINLESS STEEL</b>						
28	CEWELD 4316 Ti	3581-A: E 19 9 L R 12	A 5.4: E 308L-16	FM5	F-No. 4	1/8
29	CEWELD 4316 H	3581-A: E 19 9 R 12	A 5.4: E 308H-16	FM5	F-No. 4	1/8
30	CEWELD 4316 Ti	3581-A: E 19 9 L B 12	A 5.4: E 308L-16	FM5	F-No. 4	1/8
31	CEWELD 4551 Ti	3581-A: E 19 9 Nb R 12	A 5.4: E 347-16	FM5	F-No. 4	1/8
<b>8. FOR CRNIMO STAINLESS STEEL</b>						
32	CEWELD 4430 H	3581-A: E 19 12 3 R 12	A 5.4: E 316H-16	FM5	F-No. 4	1/9
33	CEWELD 4430 Ti	3581-A: E 19 12 3 L R 12	A 5.4: E 316L-16	FM5	F-No. 4	1/9
34	CEWELD 4430 Ti Fall	3581-A: E 19 12 3 L R 11	A 5.4: E 316L-17	FM5	F-No. 4	1/9
35	CEWELD 4440 AC	3581-A: -E 18 16 5 L R 32	A 5.4: E 317L-17	FM5	F-No. 4	1/9
36	CEWELD 4462 Ti	3581-A: E 22 9 3 N L R 12	A 5.4: E 2209-17	FM5	F-No. 4	1/9
37	CEWELD 4462 Kb	3581-A: E 22 9 3 N L B 22	A 5.4: E 2209-17	FM5	F-No. 4	1/9
38	CEWELD 4460 Cu	3581-A: E 25 9 3 N L R 32	A 5.4: E 2593-26	FM5	F-No. 4	1/9
39	CEWELD 4539 Ti	3581-A: E 20 25 5 Cu L R 32	A 5.4: E 385-26	FM5	F-No. 4	1/9
40	CEWELD 4576 Ti	2560-A: E 19 12 3 Nb R 12	A 5.4: E 318-16	FM5	F-No. 4	1/10
<b>9. FOR HEAT-RESISTANT STAINLESS STEEL</b>						
41	CEWELD 4820 AC	3581-A: E 25 4 R 32	A 5.4: -	FM5	-	1/10
42	CEWELD 4332 R	3581-A: E 23 12 LR 32	A 5.4: E 309L-17	FM5	F-No. 4	1/10
43	CEWELD 4332 Ti	3581-A: E 23 12 LR 32	A 5.4: E 309L-26	FM5	F-No. 1	1/10
44	CEWELD 4829 MoTi	3581-A: E 23 12 2 LR 32	A 5.4: E 309Mo-26	FM5	F-No. 1	1/10
45	CEWELD 4842 Ti	3581-A: E 25 20 R 32	A 5.4: E 310-16	FM5	F-No. 4	1/10
46	CEWELD 4842 Kb	3581-A: E 25 20 B 12	A 5.4: E 310-15	FM5	F-No. 4	1/10

# 1 STICK ELECTRODES - Overview

No.	Product Name	ISO	ASME	FM Group	F-Number:	Page
47	CEWELD 4850 Kb	3581-A: ~EZ 21 33 Nb B 32	A 5.4: -	FM5	-	1/10
48	CEWELD 4853 Kb	3581-A: ~EZ 25 35 Nb B 32	A 5.4: -	FM5	-	1/10
<b>10. FOR DIFFICULT TO WELD STEELS</b>						
49	CEWELD 4370 Kb	3581-A: E 18 8 Mn B 22	A 5.4: ~E 307-15	FM5	F-No. 5	1/11
50	CEWELD 4370 Ti	3581-A: E 18 9 Mn Mo R 12	A 5.4: E 307-16	FM5	F-No. 5	1/11
51	CEWELD 4370 HLS	3581-A: E 18 8 Mn R 53	A 5.4: E 307-26	FM5	F-No. 1	1/11
52	CEWELD Croni 29/9 S	3581-A: E 29 9 R 12	A 5.4: E 312-16	FM5	F-No. 5	1/11
53	CEWELD Croni 29/9 HLS	3581-A: E 29 9 R 53	A 5.4: E 312-16	FM5	F-No. 5	1/11
54	CEWELD Cronimo Ti	3581-A: E 20 10 3 RB 32	A 5.4: E 308Mo-16	FM5	F-No. 5	1/11
55	CEWELD Cronimo HLS	3581-A: E 20 10 3 RB 53	A 5.4: E 308Mo-26	FM5	F-No. 1	1/11
<b>11. FOR NICKEL BASED ALLOYS</b>						
56	CEWELD E NiTi3	14172: E Ni 2061 (NiTi3)	A 5.11: E Ni-1	FM6	F-No. 41	1/12
57	CEWELD E NiCu30Mn	14172: E Ni 4060 (NiCu30Mn3Ti)	A 5.11: E NiCu-7	FM6	F-No. 42	1/12
58	CEWELD E NiCro HLS	14172: ~E Ni 6082 (NiCr20Mn3Nb)	A 5.11: ~E NiCrFe-3	FM6	F-No. (~43)	1/12
59	CEWELD E NiCro A	14172: E Ni 6133 (NiCr16Fe12NbMo)	A 5.11: E NiCrFe-2	FM6	F-No. 43	1/12
60	CEWELD E NiCro 600	14172: E Ni 6182 (NiCr15Fe6Mn)	A 5.11: E NiCrFe-3	FM6	F-No. 43	1/12
61	CEWELD E NiCro 825	14172: E Ni 8165 (NiCr25Fe30Mo)	A 5.11: -	FM6	F-No. -	1/12
62	CEWELD E NiCrMo 622	14172: E Ni 6022 (NiCr21Mo13W3)	A 5.11: E NiCrMo-10	FM6	F-No. 43	1/12
63	CEWELD E Alloy C-276	14172: E Ni 6276 (NiCr15Mo15Fe6W4)	A 5.11: E NiCrMo-4	FM6	F-No. 43	1/13
64	CEWELD E Alloy B3	14172: E Ni 1067 (NiMo30Cr)	A 5.11: E NiMo-10	FM6	F-No. 43	1/13
65	CEWELD E Alloy HX	14172: E Ni 6002 (NiCr22Fe18Mo)	A 5.11: E NiCrMo-2	FM6	F-No. 43	1/13
66	CEWELD E NiCro 625 HLS	14172: E Ni 6625 (NiCr22Mo9Nb)	A 5.11: E NiCrMo-3	FM6	F-No. 43	1/13
67	CEWELD E NiCro 625	14172: E Ni 6625 (NiCr22Mo9Nb)	A 5.11: E NiCrMo-3	FM6	F-No. 43	1/13
68	CEWELD E NiCrMo 686 CPT	14172: E Ni 6686 (NiCr21Mo16W4)	A 5.11: E NiCrMo-14	FM6	F-No. 43	1/13
69	CEWELD E NiCrCo 617	14172: E Ni 6117 (NiCr22Co12Mo)	A 5.11: E NiCrCoMo-1	FM6	F-No. 43	1/13
<b>12. SHOCK AND ABRASION RESISTANT</b>						
70	CEWELD E DUR 300 Kb	14700: E Fe1 (DIN 8555: E 1-UM-300-P)	-	-	-	1/14
71	CEWELD E DUR 350 Kb	14700: E Fe1 (DIN 8555: E 1-UM-400-P)	-	-	-	1/14
72	CEWELD E DUR 400 Kb	14700: E Fe3 (DIN 8555: E 3-UM-400-P)	-	-	-	1/14
73	CEWELD E DUR 400 CrMo	14700: E Fe3 (DIN 8555: E 3-UM-40-PT)	-	-	-	1/14
74	CEWELD E DUR 600 Kb	14700: E Fe8 (DIN 8555: E 6-UM-60)	-	-	-	1/14
75	CEWELD E DUR 600 AC	14700: E Fe8 (DIN 8555: E6-UM-60-GP)	-	-	-	1/14
<b>13. HIGH WEAR RESISTANT</b>						
76	CEWELD E DUR 55	14700: E Fe7 (DIN 8555: E3-UM-50-CKRTZ)	A 5.13: E FeCr-A1	-	F-No. 71	1/14
77	CEWELD E DUR 60	14700: E Fe14 (DIN 8555: E10-UM-60)	A 5.13: ~E FeCr-A1A	-	F-No. 71	1/15
78	CEWELD E DUR 60 Kb	14700: E Fe8 (DIN 8555: E6-UM-60)	A 5.13: ~E Fe3	-	F-No. 71	1/15
79	CEWELD E DUR 62 S	14700: E Fe15 (DIN 8555: E 10-UM-65-GRZ)	A 5.13: ~E FeCr-A8	-	F-No. 71	1/15
80	CEWELD E DUR 63 Nb	14700: E Fe15 (DIN 8555: E 10-UM-65-GRZ)	A 5.13: ~E FeCr-E4	-	F-No. 71	1/15
81	CEWELD E DUR CE-Tube 62	14700: ~E Fe15 (DIN 8555: E 10-UM-60-GZ)	A 5.13: ~E FeCr-A7	-	F-No. 71	1/15
82	CEWELD E DUR 64	14700: E Fe16 (DIN 8555: E 10-UM-65-GTZ)	A 5.13: E FeCr-E4	-	F-No. 71	1/15
83	CEWELD E DUR 68 T	14700: ~E Fe14 (DIN 8555: E 10-UM-70-GTRZ)	A 5.13: ~E FeCr-A8	-	F-No. 71	1/15
<b>14. FOR FERRITIC &amp; MARTENSITIC STAINLESS STEEL</b>						
84	CEWELD 4009 Ti	3581-A: E 13 B 42	A 5.4: E 410-26	FM5	F-No. 1	1/15
85	CEWELD 4015 HL-Kb	3581-A: E 17 B 42	A 5.4: E 430-26	FM5	F-No. 1	1/15
<b>15. STELLITE ( COBALT BASED ALLOYS)</b>						
86	CEWELD E DUR 1U	14700: E Co3 (DIN 8555: E 20-UM-55-CTZ)	A 5.13: E CoCr-C	-	F-No. 71	1/16
87	CEWELD E DUR 6U	14700: E Co2 (DIN 8555: E 20-UM-40-CTZ)	A 5.13: E CoCr-A	-	F-No. 71	1/16
88	CEWELD E DUR 12U	14700: E Co3 (DIN 8555: E20-UM-50-CSTZ)	A 5.13: E CoCr-B	-	F-No. 71	1/16
89	CEWELD E DUR 21U	14700: E Co1 (DIN 8555: E 20-UM-350-CTZ)	A 5.13: E CoCr-E	-	F-No. 71	1/16
90	CEWELD E DUR 25U	14700: ~E Co1 (DIN 8555: E 20-UM-300-CTZ)	A 5.13: -	-	-	1/16
<b>16. FOR CUTTING EDGES - TOOL STEEL</b>						
91	CEWELD E DUR SS 60Ti	14700: E Fe4 (DIN 8555: E4-UM-60-ST)	A 5.13: ~E Fe6	-	F-No. 71	1/16
<b>17. MANGANESE BASED</b>						
92	CEWELD E DUR Mn14	14700: E Fe9 (DIN 8555: E 7-UM-250-K)	A 5.13: E FeMn-A	-	F-No. 71	1/16
93	CEWELD E DUR MnCr	14700: E Fe9 (DIN 8555: E 7-UM-250-K)	A 5.13: E FeMnCr	-	F-No. 71	1/16

# Overview - STICK ELECTRODES 1

No.	Product Name	ISO	ASME	FM Group	F-Number:	Page
<b>18. TUNGSTEN CARBIDE ALLOY</b>						
94	CEWELD E DUR R	14700: E Fe20 (DIN 8555 : E21-GF-UM-60-GP)	A 5.13: -	-	-	1/17
95	CEWELD E DUR R(Ni)	14700: E Ni20 (DIN 8555 : E21-GF-UM-60-GP)	A 5.13:	-	-	1/17
96	CEWELD E DUR CE-Tube WC2	14700: E Fe20 (DIN 8555 : E21-GF-UM-65-GZ)	A 5.13:	-	-	1/17
<b>19. FOR ALUMINIUM AND ALUMINIUM ALLOYS</b>						
97	CEWELD E Al99,8	18273: E Al 99,0Cu (DIN 1732: EL-Al 99,8)	A 5.3: E 1100	-	F-No. 21	1/17
98	CEWELD E AISi5	18273: E AISi5 (A) (DIN 1732: EL-AISI 5)	A 5.3: E 4043	-	F-No. 23	1/17
99	CEWELD E AISi12	18273: E AISi12 (A) (DIN 1732: EL-ALSi12)	A 5.3: -	-	~F-No. 21	1/17
100	CEWELD E AlMn1	18273: E AlMn1Cu (DIN 1732: EL-ALMn1)	A 5.3: E 3003	-	F-No. 21	1/17
<b>20. ALUMINIUM BRONZE</b>						
101	CEWELD E CuAl8	17777: E6 Cu 6100A - CuAl9 (DIN 1733: EL CuAl8)	A 5.6: ~ER CuAl-A1 UNS C61000	-	F-No. 31	1/17
102	CEWELD E CuMnAlNi	17777: E Cu 6338 - CuMn13Al7Fe3Ni2 (DIN 1733: EL CuMn14Al )	A 5.6: E CuMnNiAl UNS C63380	-	F-No. 37	1/17
<b>21. FOR TIN BRONZE</b>						
103	CEWELD E Zibro	17777: E Cu 5180B - CuSn7 (DIN 1733: EL CuSn7)	A 5.6: E CuSn-C UNS C52100	-	F-No. 33	1/18
<b>22. COPPER BASE</b>						
104	CEWELD E CuMn	17777: E Cu 1893 - CuMn2	A 5.6: ~ERCu UNS C18980	-	F-No. 31	1/18
105	CEWELD E CuNi30Mn	17777: E Cu 7158 (CuNi30Mn1FeTi) (DIN 1733: EL-CuNi30Mn)	A 5.6: E CuNi UNS C71581	-	F-No. 34	1/18
<b>23. FOR CAST IRON</b>						
106	CEWELD E GGG	1071: E C FC-2 7 (DIN 8573: E (FeC-2) BG 49 )	A 5.15: -	-	-	1/18
107	CEWELD E GGGL	1071: E C St 1 (DIN 8573: ~ Fe1 / S21 )	A 5.15: ~E St	-	-	1/18
108	CEWELD E Ni	1071: E C Ni-CI (DIN 8573: E Ni-BG 13 )	A 5.15: E Ni-CI	-	-	1/18
109	CEWELD E Ni(-)	1071: E C Ni-CI (DIN 8573: E Ni-BG 22 )	A 5.15: E Ni-CI	-	-	1/18
110	CEWELD E FeNi 60 N	1071: E C NiFe-1 (DIN 8573: E NiFe-1-BG 23 )	A 5.15: E NiFe-CI	-	-	1/18
111	CEWELD E NiFe2	1071: E C NiFe-CI (DIN 8573: NiFe-1-BG 23)	A 5.15: E NiFe-CI	-	-	1/18
112	CEWELD E NiFe 60/40 K	1071: E C NiFe-CI (DIN 8573: E NiFe-1-BG 11)	A 5.15: E NiFe-CI	-	-	1/18
<b>24. FOR GOUGING AND CUTTING</b>						
113	CEWELD E Guts	-	-	-	-	1/19
<b>25. FOR UNDER WATER (WET) WELDING</b>						
114	CEWELD AquaForce HR	DIN 2302: E 42 2 Z RR 10 fr (PA,PB,PC,PD,PE,PG)	A 5.1: E 7014	FM1	F-No. 1	1/19
115	CEWELD AquaForce LC	DIN 2302: E 42 2 B 10 fr (PA,PB,PC,PD,PE,PG)	A 5.1: E 7016	FM1	F-No. 1	1/19
116	CEWELD AquaForce MG	DIN 2302: E 42 2 Z RR 10 fr (PA,PB,PC,PD,PE,PG)	A 5.1: E 6013	FM1	F-No. 1	1/19

## 1 STICK ELECTRODES

TYPE	EN -ISO and ASME -AWS	MECHANICAL PROPERTIES	ANALYSIS	APPLICATION
<b>1. CELLULOSIC NON- AND LOW - ALLOY STEEL</b>				
<b>CEWELD E 6010</b>	<b>9606-1: FM1 Sect IX QW-432: F-No. 3 2560-A: E 38 3 C 21 A5.1: E6010</b>	T > 520 MPa Y > 380 MPa E > 22% I > 47J (-30 °C)	C < 0,12 Mn ~ 0,6 Si ~ 0,2 P < 0,25 S < 0,25	<b>E 6010</b> is a <b>cellulosic coated electrode</b> for all position pipe welding designed especially for vertical down root pass welding on DC- polarity and for subsequent passes on DC+ polarity. Apart from its excellent welding and gap bridging characteristics <b>E 6010</b> offers a weld deposit with outstanding impact values and thus offers the benefit of still more safety in field welding of pipelines. <b>St: 37.2, 44.2, 37.3, 52.3, H1, H11, 37.0, 52.0, 37.4, 52.4, 35.8, 45.8, 210.7, 360.7, X42, X60, A-D</b>
<b>CEWELD E 7010</b>	<b>9606-1: FM1 Sect IX QW-432: F-No. 3 2560-A: E 42 3 C 25 A5.5: 7010-P1</b>	T > 530 MPa Y > 420 MPa E > 22% I > 47J (-20 °C)	C < 0,14 Mn ~ 1,0 Si ~ 0,18 P < 0,25 S < 0,25	<b>E 7010</b> is our <b>cellulosic electrode</b> for vertical down welding of hot and filler passes as well as for <b>capping of higher strength</b> pipe steels particularly for API grades X56 and X60 or ISO grades P360.7 TM/P385.7 TM. In general the electrode is suited for root passes, however, in most cases, even on higher strength pipes, our <b>E 6010</b> is preferred.
<b>2. RUTILE NON- AND LOW-ALLOY STEEL</b>				
<b>CEWELD E 6013 Root</b>	<b>9606-1: FM1 Sect IX QW-432: F-No. 2 2560-A: E 38 2 RB 12 A 5.1: E 6013</b>	T ~ 550 MPa Y > 380 MPa E > 22% I > 47J (-20 °C)	C < 0,10 Mn ~ 0,5 Si ~ 0,2 P < 0,25 S < 0,25	<b>E 6013 Root</b> is a <b>thick rutile-basic</b> coated electrode for welding low alloyed steels with a tensile strength up to <b>510 MPa</b> . Recommended for <b>root welding</b> in pipelines due to excellent welding properties. The weld metal deposit has high mechanical properties and can be used for a wide range of materials.
<b>CEWELD E 6013 S</b>	<b>9606-1: FM1 Sect IX QW-432: F-No. 2 2560-A: E 38 0 RC 11 A 5.1: E 6012</b>	T ~ 510 MPa Y > 360 MPa E > 22% I > 60J (-20 °C)	C < 0,08 Mn ~ 0,5 Si ~ 0,3 P < 0,25 S < 0,25	<b>E 6013 S</b> is a <b>medium thick coated</b> electrode for all kinds of steel structures and is particularly suited for welding jobs at poorly accessible points and badly prepared seams. The <b>E 6013 S</b> is weldable in all positions, in particular it is ideally suited for vertical down welds. Viscous weld metal, hence good gap bridging. Easy slag removal and electrodes can be bent very well to improve accessibility to hard to reach places.
<b>CEWELD E 6013 Fall</b>	<b>9606-1: FM1 Sect IX QW-432: F-No. 2 2560-A: E 38 0 RC 11 A 5.1: E 6013</b>	T ~ 520 MPa Y > 360 MPa E > 22% I > 47J (20 °C)	C < 0,08 Mn ~ 0,6 Si ~ 0,4 P < 0,25 S < 0,25	<b>E 6013 Fall</b> is a <b>special coated</b> electrode developed for welding in <b>vertical down position</b> on old and polluted plates such as in ship repair with badly prepared seams and / or polluted, galvanized or painted plates. The <b>E 6013 Fall</b> may be used in all positions. Viscous weld metal, hence good gap bridging. Electrodes can be bent and offers excellent resistance against moisture pick up!
<b>CEWELD E 6013 T</b>	<b>9606-1: FM1 Sect IX QW-432: F-No. 2 2560-A: E 42 0 RR 12 A 5.1: E 6013</b>	T ~ 570 MPa Y > 320 MPa E > 22% I > 47J (0 °C)	C < 0,08 Mn ~ 0,6 Si ~ 0,45 P < 0,25 S < 0,25	<b>E 6013 T</b> is a <b>thick coated</b> electrode for joining and surfacing of steel structures of all kinds in mechanical engineering, body and wagon building, in the fabrication of vessels and containers, and in ship- building. The <b>E 6013 T</b> is easily weldable and possesses excellent welding properties in <b>all positions except vertical down</b> . Easy strike, no spatter losses. Very easy slag removal. Smooth, finely rippled seam surface and low fume.
<b>CEWELD E 1000 S</b>	<b>9606-1: FM1 Sect IX QW-432: F-No. 2 2560-A: E 42 0 RC 11 A 5.1: E 6013</b>	T ~ 560 MPa Y > 420 MPa E > 22% I > 47J (0 °C)	C < 0,08 Mn ~ 0,65 Si ~ 0,45 P < 0,25 S < 0,25	<b>E 1000 S</b> is a <b>medium thick coated</b> electrode suitable for general construction and offers a very smooth seam surface. <b>E 1000 S</b> is suitable for <b>all positions</b> ; 2,5 mm can even be used in vertical down position. Medium fast freezing weld metal makes this electrode excellently suitable for root runs in vertical up position in pipe welding. The slag is self detaching and the special blue coating was developed to offer high resistance against moisture pick up.
<b>CEWELD E 7024(150)</b>	<b>9606-1: FM1 Sect IX QW-432: F-No. 1 2560-A: E 38 0 RR 53 A 5.1: E 7024</b>	T ~ 500 MPa Y > 380 MPa E > 22% I > 47J (0 °C)	C < 0,08 Mn ~ 0,55 Si ~ 0,25 P < 0,035 S < 0,035	<b>E 7024 (150)</b> is a <b>high performance</b> electrode with a <b>thick rutile coating</b> and a recovery of 150%. For joining and surfacing in mechanical engineering, body and wagon building as well as in the fabrication of vessels and containers and in shipbuilding. Moreover this electrode can be used for all kinds of steel constructions. The <b>E 7024 (150)</b> has a high current carrying capacity and good striking properties. This electrode is very economical thanks to low spatter losses and easy slag removal.
<b>CEWELD E 7024 (200)</b>	<b>9606-1: FM1 Sect IX QW-432: F-No. 1 2560-A: E 42 0 RR 74 A 5.1: E 7024</b>	T ~ 510 MPa Y ~ 430 MPa E > 22% I > 47 J (0 °C)	C < 0,08 Mn ~ 0,75 Si ~ 0,3 P < 0,035 S < 0,035	<b>E 7024 (200)</b> is a <b>high performance</b> electrode with a <b>thick rutile coating</b> and a recovery of <b>200%</b> . For joining and surfacing in mechanical engineering, body and wagon building as well as in the fabrication of vessels and containers and in shipbuilding. Moreover this electrode can be used for all kinds of steel constructions. The <b>E 7024 (200)</b> has a high current carrying capacity and good striking properties. This electrode is very economical thanks to low spatter losses and <b>easy slag removal</b> .
<b>CEWELD E 7027</b>	<b>9606-1: FM1 Sect IX QW-432: F-No. 1 2560-A: E 42 4 RA 53 A 5.1 E 7027</b>	T ~ 580 MPa Y > 420 MPa E > 22% I > 75 J (20 °C) I > 47 J (-40 °C)	C < 0,07 Mn ~ 1,0 Si ~ 0,3 P < 0,035 S < 0,035	<b>E 7027</b> is a <b>high performance</b> electrode with a <b>thick coating</b> and a recovery of <b>150%</b> . For welding heavy machinery, body and wagon building as well as in the fabrication of vessels and containers and in shipbuilding. Moreover this electrode is ideally suited for primer treated or rusty materials and offers excellent impact properties down to <b>-40 °C</b> . The <b>E 7027</b> has a high current carrying capacity and self detaching porous slag (excellent for narrow gaps where the slag is often hard to remove).

TYPE	EN -ISO and ASME -AWS	MECHANICAL PROPERTIES	ANALYSIS	APPLICATION
<b>3. BASIC ELECTRODES FOR NON- AND LOW- ALLOY STEEL</b>				
<b>CEWELD E 6018 LC</b>	<b>9606-1:</b> FM1 <b>Sect IX QW-432:</b> F-No. 4 <b>2560-A:</b> E 35 4 B 32 H5 <b>A 5.1:</b> E 6018-1	T ~ 520 MPa Y > 400 MPa E > 22% l > 200J (-20 °C)	C < 0,03 Mn ~ 0,42 Si ~ 0,27 P < 0,025 S < 0,025	<b>E 6018 LC</b> offers a <b>extremely crack resistant</b> weld metal conditioned by the <b>high basicity of the slag</b> . Low spatter loss, easy slag removal. Well suited for joining high carbon steels and when welding critical mixed base metal combinations. Ideal metallurgical choice for repair welding and production as well as for use as a buffer layer. Developed for repair welding of pipes using half shells or T split joints. <b>Extremely low hydrogen content: HD &lt; 3ml/100g.</b>
<b>CEWELD E 7016</b>	<b>9606-1:</b> FM1 <b>Sect IX QW-432:</b> F-No. 4 <b>2560-A:</b> E 42 4 B 12 H10 <b>A 5.1:</b> E 7016	T ~ 580 MPa Y > 420 MPa E > 22% l > 47J (-40 °C)	C < 0,05 Mn ~ 1,0 Si ~ 0,65 P < 0,035 S < 0,035	<b>E 7016</b> is a <b>Double-coated</b> semi basic <b>CTOD tested</b> electrode with excellent welding properties in difficult positions and shows <b>high mechanical properties</b> . It is particularly suited for cheap welding machines with low open voltage on AC and DC+. Excellently suited for <b>old and rusty material</b> because of its stable and intensive arc. Well suited for root runs and in the maintenance and repair sector due to its absolute insensitiveness for rust or diluted base metals. Hydrogen content: <b>HD &lt; 10ml/100g</b> weld metal.
<b>CEWELD E 7018-1</b>	<b>9606-1:</b> FM1 <b>Sect IX QW-432:</b> F-No. 4 <b>2560-A:</b> E 42 4 B 32 H5 <b>A 5.1:</b> E 7018-1 H4R	T ~ 620 MPa Y > 440 MPa E > 22% l > 47J (-40 °C)	C < 0,08 Mn ~ 1,0 Si ~ 0,60 P < 0,035 S < 0,035	<b>E 7018-1</b> is a <b>low-hydrogen electrode</b> suitable for highly stressed joints with very easy weldability and extreme high mechanical properties for steel and steel castings <b>up to 610 MPa</b> tensile strength and fine-grained steels with increased yield strength. It is particularly suited for welding on AC and DC+. The <b>E 7018-1</b> is suitable for steel with up to 0.6% carbon and has an <b>extremely low hydrogen content. HD &lt; 3 ml/100g.</b> <b>E 7018-1</b> fulfills the US Military specifications (M designation) according AWS against moisture pick up.
<b>4. FOR CREEP RESISTING STEEL</b>				
<b>CEWELD E 7018-A1</b>	<b>9606-1:</b> FM1 / FM3 <b>Sect IX QW-432:</b> F-No. 4 <b>3580-A:</b> E Mo B 42 H5 <b>(2560-A):</b> (E 46 4 Mo B 42 H5) <b>A 5.5:</b> E 7018-A1	T ~ 520 MPa Y > 320 MPa E > 22% l > 47J (-40 °C)	C < 0,10 Mn ~ 0,80 Mo ~ 0,50 Si ~ 0,50 P < 0,035 S < 0,035	<b>E 7018-A1</b> offers excellent welding characteristics and easy slag removal with remarkable out of position weldability. Suited for working temperatures of <b>-40 °C to +525 °C</b> . Mostly used for the construction of boilers and pipes (15Mo3). Hydrogen content <b>HD &lt; 5 ml/100 g</b> weld metal <b>17Mn4, 19Mn5, 15Mo3, 16Mo3, P235GH, P265GH, P295GH, P310GH, A 204 Gr. A-C</b>
<b>CEWELD E 8018-B2</b>	<b>39606-1:</b> FM3 <b>Sect IX QW-432:</b> F-No. 4 <b>580-A:</b> E CrMo1 B 42 H5 <b>A 5.5:</b> E 8018-B2	T ~ 610 MPa Y > 470 MPa E > 22% l > 90J (20 °C)	C < 0,10 Mn ~ 0,80 Mo ~ 0,50 Si ~ 0,50 P < 0,035 S < 0,035 Cr ~ 1,10	<b>E 8018-B2</b> is a basic electrode for welding of steam production plants, steam pipes and similar joints made of <b>Cr-Mo alloyed steel</b> . The weld metal is resistant to working temperatures <b>up to 550 °C</b> . as for similarly alloyed steels, quenched and tempered for cementation and nitriding. Hydrogen content: <b>HD &lt; 5 ml/100 g</b> weld metal <b>13CrMo44, 15CrMo3, 13CrMoV42, 15Cr3, 16MnCr5, 20MnCr5, 15CrMo5, 25CrMo4, GS-22CrMo5, GS-22CrMo54</b>
<b>CEWELD E 9018-B3</b>	<b>9606-1:</b> FM3 <b>Sect IX QW-432:</b> F-No. 4 <b>3580-A:</b> E CrMo2 B 42 H5 <b>A 5.5:</b> E9018-B3 H4R	<b>PWHT 690°C/2h</b> T ~ 680 MPa Y > 490 MPa E > 18% l > 95J (20 °C)	C < 0,06 Mn ~ 0,90 Mo ~ 1,0 Si ~ 0,50 P < 0,035 S < 0,035 Cr ~ 2,40	<b>E 9018-B3</b> offers excellent welding properties with low spatter formation and very stable arc. Suitable for welding in all positions except vertical down. Excellent gap bridging for root welding. <b>118% recovery</b> type for economic production of creep resistant steels and high-pressure hydrogen resistant <b>2¼Cr1Mo-steels.</b> <b>10CrMo9.10, 12CrMo9-10, 10CrSiMoV7, 12CrSiMo8, 30CrMoV9, GS-18CrMo9.10</b>
<b>CEWELD E 9018-B9</b>	<b>9606-1:</b> FM3 <b>Sect IX QW-432:</b> F-No. 4 <b>3580-A:</b> E CrMo91 B42 H5 <b>A 5.5:</b> E 9018-B9	T ~ 700 MPa Y > 520 MPa E > 17% l > 50J (20 °C)	C < 0,09 Mn ~ 0,90 Mo ~ 0,90 Ni ~ 0,40 Si ~ 0,30 P < 0,035 S < 0,035 Cr ~ 9,0 V ~ 0,20 Nb ~ 0,06	<b>E 9018-B9</b> is designed to weld equivalent 'type T91' T92 CrMo steels modified with small additions of niobium and vanadium to give improved long term creep properties. These consumables are specifically intended for high integrity structural service at elevated temperature, so the minor alloy additions responsible for its creep strength are kept above the minimum considered necessary to ensure satisfactory performance.  <b>Also available as type CEWELD 9018-B9 (P92)</b>
<b>5. FOR WEATHER RESISTANT STEEL</b>				
<b>CEWELD E Corten</b>	<b>9606-1:</b> FM1 <b>Sect IX :</b> F-No. 4 <b>2560-A:</b> E 46 4 ZB 42 H5 <b>A 5.5:</b> E 7018-G	T ~ 600 MPa Y > 460 MPa E > 22% l > 47J (-40 °C)	C < 0,06 Mn ~ 1,0 Si ~ 0,50 P < 0,035 S < 0,035 Ni ~ 0,70 Cu < 0,50	<b>E Corten</b> is a <b>basic electrode</b> for <b>weather resistant steel</b> such as, Patinax, Corten, Acor 50, HSB 51, etc. Excellent mechanical properties and well suited for use at sub zero temperatures <b>Weather resistant steels, WTSSt 37, WTSSt 52, Corten A, B, C, Patinax 37, RBH 35, Acor 37, Acor 50, HSB 51, HSB 55 C, 1.8962, 1.8963, 1.8965, 1.8960</b>



## 1 STICK ELECTRODES

TYPE	EN -ISO and ASME -AWS	MECHANICAL PROPERTIES	ANALYSIS	APPLICATION
<b>6. FOR HIGH - STRENGTH LOW ALLOY AND FINE GRAIN STEEL</b>				
<b>CEWELD E 8018-C1</b>	<b>9606-1: FM1 Sect IX QW-432: F-No. 4 2560-A: E 50 8 2Ni B 42 H5 A 5.5: E 8018-C1</b>	T ~ 630 MPa Y > 510 MPa E > 22% I > 55J (-80 °C)	C < 0,05 Mn ~ 1,0 Si ~ 0,5 P < 0,15 S < 0,15 Ni ~2,3	<b>E 8018-C1</b> offers excellent arc stability and <b>easy slag removal</b> with low spatter losses. Developed for <b>high impact strength</b> properties at extreme sub zero temperatures. Hydrogen content is less than <b>HD &lt; 4ml/100g weld metal.</b> <b>2,3 % Ni Type 380 to 500 MPa Steel</b>
<b>CEWELD E 8018-C2</b>	<b>9606-1: FM1 Sect IX QW-432: F-No. 4 2560-A: E 46 6 3Ni B 32 H5 A 5.5: E 8018-C2</b>	T ~ 620 MPa Y > 460 MPa E > 20% I > 60J (-80 °C) I > 27J (-100 °C)	C < 0,05 Mn ~ 1,0 Si ~ 0,5 P < 0,15 S < 0,15 Ni ~2,3	<b>E 8018-C2</b> offers excellent arc stability and <b>easy slag removal</b> with low spatter losses. Developed for <b>high impact strength</b> properties at extreme sub zero temperatures. Hydrogen content is less than <b>HD &lt; 4ml/100g weld metal.</b> <b>3 % Ni Type 380 to 500 MPa Steel</b>
<b>CEWELD E 8018-C3</b>	<b>9606-1: FM1 Sect IX QW-432: F-No. 4 2560-A: E 50 6 1Ni B 42 H5 A 5.5: E 8018-C3</b>	T ~ 600 MPa Y > 500 MPa <b>AW</b> Y > 460 MPa <b>SR</b> E > 22% I > 90J (-60 °C)	C < 0,07 Mn ~ 1,3 Ni ~ 0,9 Si ~ 0,5 P < 0,15 S < 0,15	<b>E 8018-C3</b> is a basic <b>offshore electrode</b> according to the latest offshore requirements for sub zero temperatures <b>down to -60 °C. CTOD tested</b> and suitable up to <b>steel types with 460 MPa yield strength</b> (such as S460), approved according to grade <b>5Y46 (LR, DNV-GL)</b> . Excellent welding properties and extremely low hydrogen content below <b>HD &lt; 3 ml/100g weld metal.</b> <b>E 8018-C3 is packed in the best in class multi layer vacuum pack to avoid costly and time consuming redrying of the electrodes.</b>
<b>CEWELD E 9018-G</b>	<b>9606-1: FM2 Sect IX QW-432: F-No. 4 18275-A: E 55 6 Mn1NiMo B 42 H5 A 5.5: E 9018-G</b>	T > 650 MPa Y > 550 MPa E > 21% I > 55 J (-60 °C)	C < 0,06 Mn ~ 1,60 Mo ~ 0,30 Ni ~ 1,0 Si ~ 0,40 P < 0,15 S < 0,15	<b>E 9018-G</b> is a <b>high basic offshore electrode</b> according the latest offshore requirements for sub zero temperatures <b>down to -60 °C.</b> Suitable for steel types <b>up to 550 MPa</b> yield strength, excellent welding properties and extremely low hydrogen content below <b>HD &lt; 3 ml/100gr weld metal.</b> The weld metal is suitable for longer post weld heat treatments as applied in riser applications. <b>Steel from 460 MPa to 550 MPa</b>
<b>CEWELD E 10018-D2</b>	<b>9606-1: FM2 Sect IX QW-432: F-No. 4 18275-A: E 62 4 MnMo B 42 H5 A 5.5: ~E 10018-D2</b>	T > 750 MPa Y > 630 MPa E > 21% I > 55 J (- 40 °C)	C < 0,09 Mn ~ 1,90 Mo ~ 0,30 Si ~ 0,50	<b>E 10018-D2</b> is recommended for welding <b>high yield strength steel &gt; 600 MPa</b> in case high impact values are required at sub zero temperatures. The ideal electrode for welding MUD pipes in offshore. <b>(Meets NACE requirements)</b> Pipeline according API standard ranging from <b>X65 up to X80.</b>
<b>CEWELD E 10018-G</b>	<b>9606-1: FM2 Sect IX QW-432: F-No. 4 18275-A: E 62 6 Mn2NiCrMo B 42 H5 A 5.5: E 10018-G</b>	T ~ 720 MPa Y > 620 MPa E > 17% I > 69J (- 40 °C)	C < 0,05 Mn ~ 1,30 Mo ~ 0,33 Ni ~ 2,0 Si ~ 0,35 Cr ~ 0,35	<b>E 10018-G</b> is a <b>Mn, Ni, Cr and Mo</b> alloyed basic electrode for welding low alloyed steels with tensile strength > <b>620 MPa.</b> Crack resistant and well suited for low-temperatures, ductility <b>down to -60 °C.</b> Preheating, interpass temperature and post weld treatment as required for the base metal. Hydrogen content: <b>HD &lt; 3 ml /100 g weld metal.</b> <b>Steel from 550 MPa to 620 MPa.</b>
<b>CEWELD E 11018-H</b>	<b>9606-1: FM2 Sect IX QW-432: F-No. 4 18275-A: E 69 6 Mn2NiCrMo B 42 H5 A 5.5: E 11018-M</b>	T > 770 MPa Y > 690 MPa E > 17% I > 69J (- 60 °C)	C 0,045 - 0,075 Mn 1,40 - 1,60 Mo 0,30 - 0,40 Ni 1,90 - 2,20 Si 0,30 - 0,45 Cr 0,30 - 0,40 V < 0,25	<b>E 11018-H</b> is a <b>Mn, Ni, Cr and Mo</b> alloyed high basic electrode for welding low alloyed steels with tensile strength > <b>690 MPa.</b> Crack resistant and well suited for low-temperatures, ductility <b>down to -60 °C.</b> Preheating, interpass temperature and post weld treatment as required for the base metal. Hydrogen content: <b>HD &lt; 3 ml/100g weld metal. Steel from 550 MPa to 690 MPa</b>
<b>CEWELD E 12018-Mo</b>	<b>9606-1: FM2 Sect IX QW-432: F-No. 4 18275-A: E 89 4 ZB62 H5 A 5.5: E 12018-G</b>	T > 1050 MPa Y > 890 MPa E > 15% I > 69J (- 40 °C)	C < 0,07 Mn ~ 1,65 Mo ~ 0,85 Ni ~ 2,60 Si ~ 0,50 Cr ~ 0,90	<b>E 12018-Mo</b> is designed for welding quenched and tempered steels with a <b>yield strength &gt; 890 MPa</b> such as <b>S960QL and TSiE960V</b> in crane building, heavy lifting earth moving equipment etc. The electrode has excellent welding characteristics, Hydrogen content <b>HD &lt; 4 ml/100 g.</b> <b>Steel from 690 MPa to 960 MPa</b>
<b>7. FOR CRNI STAINLESS STEEL</b>				
<b>CEWELD 4316-Ti</b>	<b>9606-1: FM5 Sect IX QW-432: F-No. 4 3581-A: E 19 9 L R 12 A 5.4: E 308L-16</b>	T ~ 600 MPa Y > 320 MPa E > 35% I > 70J (20 °C)	C < 0,03 Mn 0,5 - 2,5 Cr 18 - 20 Ni 9,0 - 11	<b>4316 Ti</b> is suitable for welding corrosion-resistant <b>Cr-Ni-steels</b> with extremely low C-content at working temperatures <b>up to 350 °C</b> and down to <b>-196 °C.</b> <b>W.no: 1.4300, 1.4301, 1.4306, 1.4312, 1.4371, 1.4541, 1.4543, 1.4550, 1.4552 AISI: 202, 302, 304, 304 L, 305, 321, 347</b>
<b>CEWELD 4316-H</b>	<b>9606-1: FM5 Sect IX QW-432: F-No. 4 3581-A: E 19 9 R 12 A 5.4: 308H-16</b>	T ~ 600 MPa Y > 320 MPa E > 35% I > 70J (20 °C)	C < 0,05 Mn 0,5 - 2,5 Cr 18 - 20 Ni 9,0 - 11	<b>4316 H</b> compared to standard 4316 Ti offers a weld deposit with higher temperature scale-resistance <b>up to 700 °C</b> due to the increased carbon content. <b>W.no: 1.4300, 1.4301, 1.4306, 1.4312, 1.4371, 1.4541, 1.4543, 1.4550, 1.4452</b>
<b>CEWELD 4316-Kb</b>	<b>9606-1: FM5 Sect IX QW-432: F-No. 4 3581-A: E 19 9 L B 12 A 5.4: E 308L-16</b>	T ~ 600 MPa Y > 320 MPa E > 35% I > 70J (20 °C)	C < 0,03 Mn 0,5 - 2,5 Cr 18 - 20 Ni 9,0 - 11	<b>4316 B</b> is suitable for welding corrosion-resistant <b>Cr-Ni-steels</b> with extremely low C-content at working temperatures <b>up to 350 °C.</b> The weld deposit is scale-resistant up to approx. 800°C in normal atmosphere and oxidizing gases. The weld deposit is capable of taking a high polish. <b>W.no: 1.4300, 1.4301, 1.4306, 1.4312, 1.4371, 1.4541, 1.4543, 1.4550, 1.4552 AISI: 202, 302, 304, 304 L, 305, 321, 347</b>



TYPE	EN -ISO and ASME -AWS	MECHANICAL PROPERTIES	ANALYSIS	APPLICATION
<b>CEWELD</b> <b>4551-Ti</b>	<b>9606-1: FM5</b> <b>Sect IX QW-432: F-No. 4</b> <b>3581-A:</b> E 19 9 Nb R 12 <b>A 5.4:</b> E 347-16	T ~ 600 MPa Y > 380 MPa E > 35% I > 32J (-120 °C)	C < 0,03 Mn 0,5 - 2,5 Cr 18 - 20 Ni 9,0 - 11 Nb >8x%C	<b>4551-Ti</b> is suitable for welding austenitic corrosion-resistant stabilized Cr-Ni steels for working temperatures <b>up to 400 °C</b> <b>W.no: 1.4306, 1.4301, 1.4311, 1.4312, 1.4541, 1.4543, 1.4546, 1.4550, 1.4452</b>
<b>8. FOR CRNIMO STAINLESS STEEL</b>				
<b>CEWELD</b> <b>4430-H</b>	<b>9606-1: FM5</b> <b>Sect IX QW-432: F-No. 4</b> <b>3581-A:</b> E 19 12 3 R 12 <b>A 5.4:</b> E 316 H-16	T ~ 600 MPa Y > 320 MPa E > 35% I > 70J (20 °C)	C < 0,06 Mn 0,5 - 2,5 Cr 18 - 20 Mo 2,5 - 3,0 Ni 11 - 13	<b>4430-H</b> is suitable for welding <b>corrosion-resistant Cr-Ni-Mo</b> steels for working temperatures <b>up to 700 °C</b> . <b>W.no: 1.4401, 1.4404, 1.4410, 1.4435, 1.4436, 1.4571, 1.4573, 1.4580, 1.4583</b>
<b>CEWELD</b> <b>4430-Ti</b>	<b>9606-1: FM5</b> <b>Sect IX QW-432: F-No. 4</b> <b>3581-A:</b> E 19 12 3 L R 12 <b>A 5.4:</b> E 316L-16	T ~ 550 MPa Y > 320 MPa E > 35% I > 70J (20 °C)	C < 0,03 Mn 0,5 - 2,5 Cr 18 - 20 Mo 2,5 - 3,0 Ni 11 - 13	The <b>4430-Ti</b> weld deposit is scale-resistant <b>up to 800 °C</b> in normal atmosphere and oxidizing gases. <b>Working temperatures</b> up to <b>400 °C</b> . Extreme stable arc on both <b>AC and DC+</b> with no spatter losses. The weld deposit is capable of taking a high polish. <b>W.no: 1.4583, 1.4435, 1.4436, 1.4404, 1.4406, 1.4408, 1.4401, 1.4571, 1.4580, 1.4406</b>
<b>CEWELD</b> <b>4430-Ti Fall</b>	<b>9606-1: FM5</b> <b>Sect IX QW-432: F-No. 4</b> <b>3581-A:</b> E 19 12 3 L R 11 <b>A 5.4:</b> E 316L-17	T ~ 520 MPa Y > 320 MPa E > 35% I > 70J (20 °C)	C < 0,03 Mn 0,5 - 2,5 Cr 18 - 20 Mo 2,5 - 3,0 Ni 11 - 13	The <b>4430-Ti Fall</b> is suitable for working temperatures <b>up to 400° C</b> . <b>4430 Ti Fall</b> is designed to weld in all <b>positions</b> and offers a fast freezing slag that makes it also very well suited for <b>vertical down (PG)</b> position.
<b>CEWELD</b> <b>4440-AC</b>	<b>9606-1: FM5</b> <b>Sect IX QW-432: F-No. 4</b> <b>3581-A:</b> ~E 18 16 5 L R 32 <b>A 5.4:</b> E 317L-17	T ~ 580 MPa Y > 400 MPa E > 22% I > 55J (20 °C)	C < 0,04 Mn 0,5 - 2,5 Cr 18 - 21 Mo 3,0 - 4,0 Ni 12 - 14	<b>4440-AC</b> is suitable for welding stabilized and <b>un-stabilized CrNiMo</b> type of steels with high corrosion resistance. Also suitable for dissimilar welds between steel and stainless steel or dissimilar stainless steels. Mainly used in chemical, paper and cotton industry <b>W.no: 1.3941, 1.3952, 1.3953, 1.3955, 1.3958, 1.4406, 1.4429, 1.4435, 1.4438, 1.4439</b>
<b>CEWELD</b> <b>4462-Ti</b>	<b>9606-1: FM5</b> <b>Sect IX QW-432: F-No. 4</b> <b>3581-A:</b> E 22 9 3 N L R 12 <b>A 5.4:</b> E 2209-17	T ~ 690 MPa Y > 480 MPa E > 25% I > 50J (20 °C)	C < 0,04 Mn 0,5 - 2,5 Cr 21,5 - 23,5 Mo 3,0 - 4,0 Ni 12 - 14 N ~ 0,15	<b>4462-Ti</b> is a <b>rutile</b> basic electrode for welding austenitic-ferritic stainless alloys of the <b>22% Cr, 5% Ni, 3% Mo types</b> . 2209 has high general corrosion resistance. In media containing chloride and hydrogen sulphide, the alloy has a high resistance to intergranular corrosion, pitting and especially to stress corrosion. <b>W.no:1.4462, 1.4417, 1.4582, 1.4463, 1.4460, 1.4362, 1.4583</b>
<b>CEWELD</b> <b>4462-Kb</b>	<b>9606-1: FM5</b> <b>Sect IX QW-432: F-No. 4</b> <b>3581-A:</b> E 22 9 3 N L B 22 <b>A 5.4:</b> E 2209-17	T ~ 690 MPa Y > 480 MPa E > 25% I > 60J (20 °C) I > 47J (-40 °C)	C < 0,04 Mn 0,5 - 2,5 Cr 21,5 - 23,5 Mo 3,0 - 4,0 Ni 12 - 14 N ~ 0,15	<b>4462-Kb</b> is a <b>basic</b> electrode for welding austenitic-ferritic stainless alloys of the <b>22% Cr, 5% Ni, 3% Mo types</b> . 2209 has high general corrosion resistance. In media containing chloride and hydrogen sulphide, the alloy has a high resistance to intergranular corrosion, pitting and especially to stress corrosion. <b>W.no:1.4462, 1.4417, 1.4582, 1.4463, 1.4460, 1.4362, 1.4583</b>
<b>CEWELD</b> <b>4460-Cu</b>	<b>9606-1: FM5</b> <b>Sect IX QW-432: F-No. 4</b> <b>3581-A:</b> E 25 9 3 N L R 32 <b>A 5.4:</b> E 2593-26	T ~ 690 MPa Y > 480 MPa E > 25% I > 60J (20 °C) I > 47J (-40 °C)	C < 0,04 Mn 0,5 - 2,5 Cr 24,0 - 27,0 Mo 3,0 - 4,0 Ni 8,5 - 9,5 N ~ 0,15 Cu 0,5 - 0,8	<b>4460-Cu</b> is a <b>rutile basic</b> electrode with extreme high corrosion resistance and mechanical properties. Welding wrought, forged or cast super duplex stainless steels for service in the as-welded Condition. Heterogeneous welding between super duplex stainless steels and dissimilar welds between other stainless and mild or low alloyed steels. Examples <b>UNS S32550 :UR 52 N, Ferralium 255, UNS S32520 :UR 52 N+, UNS S32750 SAF 2507, UR 47 N+, UNS S32760 :ZERON 100, UNS 32760, UR 76 N, SM22Cr, SAF 2507, ASTM S32760 (ZERON 100), S32550 and S31260, 2205, 1.4460, 1.4462,1.4463,1.4515, 1.4517, 1.4507 URANUS 52N, SAF 25.07, GX 3 CrNiMoCuN 26-6-3, (1.4515), GX 3 CrNiMoCuN 26-6-3-3, (1.4517), 25% Cr, S32750 1.4410 - 25Cr-7Ni-4Mo-0.28N, NAS74N, 1.4501 - 25Cr-7Ni-3.8Mo-0.7Cu-0.7W-0.25N, S32506 - SUS329J4L 25Cr-7Ni-3Mo-0.15N-0.2W NAS64 1.4507, S31803, S32205</b>
<b>CEWELD</b> <b>4539-Ti</b>	<b>9606-1: FM5</b> <b>Sect IX QW-432: F-No. 4</b> <b>3581-A:</b> E 20 25 5 Cu L R 32 <b>A 5.4:</b> E 385-26	T ~ 600 MPa Y > 380 MPa E > 32% I > 30J (20 °C)	C < 0,03 Mn 1,0 - 2,5 Cr 19,5 - 21,5 Mo 4,2 - 5,2 Ni 24 - 26 Cu 1,2 - 2,0	<b>4539-Ti</b> offers excellent corrosion resistance especially against phosphoric acid. The weld deposit is capable of taking a high polish <b>W.no: 1.4500, 1.4505, 1.4506, 1.4519, 1.4531, 1.4536, 1.4539, 1.4573, 1.4585, 1.4586, UNS N08904</b>
<b>CEWELD</b> <b>4576-Ti</b>	<b>9606-1: FM5</b> <b>Sect IX QW-432: F-No. 4</b> <b>3581-A:</b> E 19 12 3 Nb R 12 <b>A 5.4:</b> E 318-16	T ~ 650 MPa Y > 440 MPa E > 30% I > 32J (-120 °C)	C < 0,08 Mn 0,5 - 3,0 Cr 17 - 20 Mo 2,5 - 3,0 Ni 11 - 13 Nb 6 x C ≤ 1,0	<b>4576-Ti</b> is developed for welding stabilized <b>CrNi(N)</b> and <b>CrNiMo(N)</b> types and cast steels (316Ti) <b>W.no: 1.4581, 1.4437, 1.4401, 1.4571, 1.4580, 1.4583, 1.4436</b>

## 1 STICK ELECTRODES

TYPE	EN -ISO and ASME -AWS	MECHANICAL PROPERTIES	ANALYSIS	APPLICATION
<b>9. FOR HEAT-RESISTANT STAINLESS STEEL</b>				
<b>CEWELD 4820 AC</b>	<b>9606-1: FM5</b> <b>3581-A:</b> E 25 4 R 32	T ~ 700 MPa Y > 500 MPa E > 20% I > 27J (20 °C)  180 HB	C < 0,15 Mn 0,5 - 2,5 Cr 24 - 27 Ni 4,0 - 6,0	<b>4820-AC</b> is a rutile-basic electrode for joint- and hard face welding on equal or <b>25% Cr</b> alloys. The weld-deposit is resistant to air and exhaust gases <b>up to 1150 °C</b> . Also in a sulphuric environment at high temperatures.
<b>CEWELD 4332 R</b>	<b>9606-1: FM5</b> <b>Sect IX QW-432: F-No. 4</b> <b>3581-A:</b> E 23 12 LR 32 <b>A 5.4:</b> E 309L-17	T ~ 550 MPa Y > 400 MPa E > 30% I > 47J (20 °C)	C < 0,04 Mn 0,5 - 2,5 Cr 22 - 23 Ni 11 - 14 Si < 1,2	<b>4332-R</b> is suitable for joining heat resistant <b>CrNi-steels</b> of the same kind and also joining dissimilar metals such as steel to stainless steel. Cladding on low alloyed steels in case a <b>18/8 CrNi layer</b> is required in the first layer. <b>Scale resistant up to 1050 °C</b> . <b>W.no: 1.4541, 1.4550, 1.4710, 1.4712, 1.4727, 1.4729, 1.4740, 1.4742, 1.4780, 1.4825, 1.4826, 1.4828, 1.4878</b>
<b>CEWELD 4332 Ti</b>	<b>9606-1: FM5</b> <b>Sect IX QW-432: F-No. 1</b> <b>3581-A:</b> E 23 12 LR 32 <b>A 5.4:</b> E 309L-26	T ~ 550 MPa Y > 400 MPa E > 30% I > 55J (20 °C)	C < 0,04 Mn 0,5 - 2,5 Cr 22 - 23 Ni 11 - 14 Si < 1,2	<b>4332-Ti</b> is a rutile basic electrode for joining heat resistant <b>CrNi-steels</b> of the same kind and also joining dissimilar metals such as steel to stainless steel. Cladding on low alloyed steels in case a <b>18/8 CrNi layer</b> is required in the first layer. <b>Scale resistant up to 1050 °C</b> . <b>W.no: 1.4541, 1.4550, 1.4710, 1.4712, 1.4727, 1.4729, 1.4740, 1.4742, 1.4780, 1.4825, 1.4826, 1.4828, 1.4878</b>
<b>CEWELD 4829 MoTi</b>	<b>9606-1: FM5</b> <b>Sect IX QW-432: F-No. 1</b> <b>3581-A:</b> E 23 12 2 LR 32 <b>A 5.4:</b> E 309Mo-26	T ~ 650 MPa Y > 480 MPa E > 25% I > 32J (-20 °C)	C < 0,12 Mn 0,5 - 2,5 Cr 23 - 25 Ni 13 - 14 Mo 2,0 - 3,0	<b>4829-MoTi</b> is suitable for joining heat resistant <b>CrNi(Mo)-steels</b> of the same kind and also joining dissimilar alloys such as steel to stainless steel. Cladding on low alloyed steels in case a <b>18/8/2 CrNiMo layer</b> is required in the first layer. <b>W.no: 1.4401, 1.4404, 1.4406, 1.4410, 1.4437, 1.4571, 1.4580</b>
<b>CEWELD 4842 Ti</b>	<b>9606-1: FM5</b> <b>Sect IX QW-432: F-No. 4</b> <b>3581-A:</b> E 25 20 R 32 <b>A 5.4:</b> E 310-16	T ~ 600 MPa Y > 410 MPa E > 29% I > 70J (20 °C)	C 0,06 - 0,2 Mn 1,0 - 2,5 Cr 25 - 27 Ni 20 - 22 Si < 0,75 Mo < 0,75	<b>4842-Ti</b> is a rutile/basic electrode for welding heat-resistant austenitic steels of the <b>25% Cr, 20% Ni types</b> . Scale resistance <b>up to 1150 °C</b> . No resistance in sulphuric environments. This alloy can withstand relatively severe thermal shock, and is superior to type 309 L. <b>W.no: 1.4823, 1.4826, 1.4828, 1.4832, 1.4840, 1.4841, 1.4846, 1.4848, 1.4837, 1.4710, 1.4713, 1.4724, 1.4726, 1.4742, 1.4745, 1.4762, 1.4845, 1.4849</b>
<b>CEWELD 4842 Kb</b>	<b>9606-1: FM5</b> <b>Sect IX QW-432: F-No. 4</b> <b>3581-A:</b> E 25 20 B 12 <b>A 5.4:</b> E 310-15	T ~ 650 MPa Y > 410 MPa E > 29% I > 70J (20 °C) I > 32J (-196 °C)	C 0,06 - 0,2 Mn 1,0 - 2,5 Cr 25 - 27 Ni 20 - 22 Si < 0,75 Mo < 0,75	<b>4842 Kb</b> is a basic electrode for welding heat-resistant austenitic steels of the <b>25% Cr, 20% Ni types</b> . Scale resistance <b>up to 1150 °C</b> . No resistance in sulphuric environments. This alloy can withstand relatively severe thermal shock, and is superior to type 309 L. <b>W.no: 1.4823, 1.4826, 1.4828, 1.4832, 1.4840, 1.4841, 1.4846, 1.4848, 1.4837, 1.4710, 1.4713, 1.4724, 1.4726, 1.4742, 1.4745, 1.4762, 1.4845, 1.4849 heat resistant stainless steel, AISI 305, 310, 314, ASTM A297 HF, A297 HJ</b>
<b>CEWELD 4850 Kb</b>	<b>9606-1: FM5</b> <b>3581-A:</b> ~EZ 21 33 Nb B 32	T ~ 600 MPa Y > 380 MPa E > 25% I > 50J (20 °C)	C 0,12 - 0,18 Cr 21 - 23 Ni 32 - 35 Nb 0,9 - 1,2 Mn ~ 4,5	<b>4850 Kb</b> offers high corrosion resistance and excellent weldability on both AC and DC+. The weld deposit is scale resistant <b>up to 1050 °C</b> . <b>W.no: 1.4859 - GX10NiCrNb32-20; 1.4876 - X10NiCrAlTi32-20; X10NiCrAlTi32-20 - Alloy 800 H, 1.4861</b>
<b>CEWELD 4853 Kb</b>	<b>9606-1: FM5</b> <b>3581-A:</b> ~EZ 25 35 Nb B 32	T ~ 700 MPa Y > 460 MPa E > 8%	C 0,3 - 0,5 Mn 0,9 - 1,1 Cr 25 - 27 Ni 34 - 36 Si ~ 0,9 Nb 1,2 - 1,5	<b>4853 Kb</b> is suitable for joining and cladding high heat resistant <b>CrNi-steels</b> of the same kind and cast steels in a low sulphuric environment. <b>W.no: 1.4852, 1.4853 G-X 40 NiCrNb 35 25, 1.4857, G-X 40 NiCrSi 35 25, 1.4837, G-X40CrNiSi25-12, 1.4848, G-X40CrNiSi25--20, 1.4849, G-X40NiCr38-18, G-X40NiCrNb35-25, cast steels, HK40, HK45, UNS: J93503, J94204, N08705</b>

TYPE	EN -ISO and ASME -AWS	MECHANICAL PROPERTIES	ANALYSIS	APPLICATION
------	-----------------------	-----------------------	----------	-------------

## 10. FOR DIFFICULT TO WELD STEELS

<b>CEWELD</b> <b>4370 Kb</b>	<b>9606-1: FM5</b> <b>Sect IX QW-432: F-No. 5</b> <b>3581-A:</b> E 18 8 Mn B 22 <b>A 5.4:</b> ~E 307-15	T ~ 600 MPa Y > 350 MPa E > 35% I > 75J (20 °C) 200-400 HB	C < 0,2 Mn 4,5 - 7,0 Cr 17 - 20 Ni 7,0 - 10	<b>4370 Kb</b> is a basic electrode. Excellent weldability with good scale and corrosion resistance <b>up to 900 °C</b> . Extremely high elongation and impact values makes this electrode an excellent choice for critical welding applications. Working temperature <b>up to 300°C</b> . <b>Dissimilar joints, hard to weld materials, buffer layers.</b> <b>Armor plates , tool-, spring-, manganese steels:</b> <b>X 120 Mn 12 (1.3401), 45S7, 51S7; 56SC7, 45C4, C45 etc.</b>
<b>CEWELD</b> <b>4370 Ti</b>	<b>9606-1: FM5</b> <b>Sect IX QW-432: F-No. 5</b> <b>3581-A:</b> E 18 9 Mn Mo R 12 <b>A 5.4:</b> E 307-16	T ~ 600 MPa Y > 370 MPa E > 40% I > 70J (20 °C) 200-400 HB	C < 0,2 Mn 4,5 - 7,0 Cr 17 - 20 Ni 7,0 - 10 Mo ~0,5	<b>4370 Ti</b> is a rutile electrode. Excellent weldability with good scale and corrosion resistant <b>up to 900 °C</b> . Extreme high elongation and impact values makes this electrode a excellent choice for critical welding applications. Working temperature <b>up to 300° C</b> . <b>Dissimilar joints, hard to weld materials, buffer layers.</b> <b>Armor plate , tool-, spring-, manganese steels:</b> <b>X 120 Mn 12 (1.3401), 45S7, 51S7; 56SC7, 45C4, C45</b>
<b>CEWELD</b> <b>4370 HLS</b>	<b>9606-1: FM5</b> <b>Sect IX QW-432 : F-No. 1</b> <b>3581-A:</b> E 18 8 Mn R 53 <b>A 5.4:</b> E 307-26	T ~ 600 MPa Y > 370 MPa E > 40% I > 70J (20 °C) 200-400 HB	C < 0,2 Mn 4,5 - 7,0 Cr 17 - 20 Ni 7,0 - 10	<b>4370 HLS</b> is a high recovery rutile electrode. Excellent weldability with good scale and corrosion resistant <b>up to 900 °C</b> . Extreme high elongation and impact values makes this electrode a excellent choice for critical welding applications. Working temperature <b>up to 300 °C</b> . <b>Dissimilar joints, hard to weld materials, buffer layers.</b> <b>Armor plate , tool-, spring-, manganese steels:</b> <b>X 120 Mn 12 (1.3401), 45S7, 51S7; 56SC7, 45C4, C45</b>
<b>CEWELD</b> <b>CroNi 29/9 S</b>	<b>9606-1: FM5</b> <b>Sect IX QW-432: F-No. 5</b> <b>3581-A:</b> E 29 9 R 12 <b>A 5.4:</b> E 312-16	T ~ 600 MPa Y > 370 MPa E > 40% I > 70J (20 °C) 200-400 HB	C < 0,15 Si < 1,0 Mn 0,5 - 2,5 Cr 28 - 31 Ni 8,0- 10,5 Mo < 0,75	<b>Croni 29/9 S</b> is a <b>austenitic-ferritic special alloy</b> suitable for joining steels that are difficult to weld. Varied applications in repair and maintenance of machines, shafts, gearwheels, especially in the field of construction machinery. Also excellent for buffer layers before hardfacing and for dissimilar welding between steel, stainless steels or unknown steels. <b>Manganese steel, spring steel, high speed tool steels (hss), C45, C60, dissimilar joints, maintenance, buffer layers, repairing cock wheels, 42MnV7, 25CrMo4, 42CrMo4, 50CrMo4, 1.5223, 1.7218, 1.7225, 1.7228, stainless steel</b>
<b>CEWELD</b> <b>CroNi 29/9 HLS</b>	<b>9606-1: FM5</b> <b>Sect IX QW-432: F-No. 5</b> <b>3581-A:</b> E 29 9 R 53 <b>A 5.4:</b> E 312-26	T ~ 600 MPa Y > 370 MPa E > 40% I > 70J (20 °C) 200-400 HB	C < 0,15 Si < 1,0 Mn 0,5 - 2,5 Cr 28 - 31 Ni 8,0- 10,5 Mo < 0,75	<b>Croni 29/9 HLS</b> is a <b>austenitic-ferritic special alloy</b> high recovery rutile electrode suitable for joining steels that are difficult to weld. Varied applications in repair and maintenance of machines, shafts, gearwheels, especially in the field of construction machinery. Also excellent for buffer layers before hardfacing and for dissimilar welding between steel, stainless steels or unknown steels. <b>Manganese steel, spring steel, high speed tool steels (hss), C45, C60, dissimilar joints, maintenance, buffer layers, repairing cock wheels, 42MnV7, 25CrMo4, 42CrMo4, 50CrMo4, 1.5223, 1.7218, 1.7225, 1.7228, stainless steel</b>
<b>CEWELD</b> <b>Cronimo Ti</b>	<b>9606-1: FM5</b> <b>Sect IX QW-432: F-No. 5</b> <b>581-A:</b> E 20 10 3 RB 32 <b>A 5.4:</b> E 308Mo-16	T ~ 600 MPa Y > 370 MPa E > 40% I > 70J (20 °C)	C < 0,08 Si < 0,10 Mn 0,5 - 2,5 Cr 18 - 21 Ni 9,0 -12 Mo 2,0 -3,0	<b>Cronimo Ti</b> is a <b>rutile/basic electrode</b> for welding dissimilar steels. <b>Suitable for welding low-alloyed steel to stainless or austenitic manganese steels.</b> Maintenance and repair welding of unknown or difficult to weld steels. Good corrosion resistance against seawater and general corrosion with excellent welding properties with self detaching slag.
<b>CEWELD</b> <b>Cronimo HLS</b>	<b>9606-1: FM5</b> <b>Sect IX QW-432: F-No. 1</b> <b>3581-A:</b> E 20 10 3 RB 53 <b>A 5.4:</b> E 308Mo-26	T ~ 600 MPa Y > 370 MPa E > 40% I > 70J (20 °C)	C < 0,08 Si < 0,10 Mn 0,5 - 2,5 Cr 18 - 21 Ni 9,0 -12 Mo 2,0 -3,0	<b>Cronimo HLS</b> is a high recovery <b>rutile/basic electrode</b> for welding <b>dissimilar steels.</b> Suitable for welding low-alloyed steel to stainless or austenitic manganese steels. Maintenance and repair welding of unknown or difficult to weld steels. Good corrosion resistance against seawater and general corrosion with excellent welding properties with self detaching slag.

## 1 STICK ELECTRODES

TYPE	EN -ISO and ASME -AWS	MECHANICAL PROPERTIES	ANALYSIS	APPLICATION
<b>11. FOR NICKEL BASED ALLOYS</b>				
<b>CEWELD</b> <b>E NiTi3</b>	<b>9606-1: FM6</b> <b>Sect IX QW-432: F-No. 41</b> <b>14172:</b> E Ni 2061 (NiTi3) <b>A 5.11:</b> E Ni-1	T ~ 640 MPa Y > 370 MPa E > 20% I > 120J (20 °C)	C < 0,1 Mn < 0,7 Fe < 0,7 Si < 1,2 Ni > 92 Al < 1,0 Ti 1,0 - 4,0 Cu < 0,2	<b>E NiTi3</b> is developed for <b>welding and cladding</b> Nickel 200 and Nickel 201. This alloy is also suited for surfacing of steel. <b>Dissimilar welding</b> applications of filler metal NiTi 3 include <b>joining Nickel 200 and 201</b> to stainless steels, copper-nickel alloys, and Monel alloys. It is also used for joining Monel alloys and copper-nickel alloys to carbon steels, and for joining copper-nickel alloys to Inconel and Incoloy alloys. <b>Nickel Alloy 200-201, UNS Nr: N 02200-N 02201.</b> <b>DIN 17 742: Ni 99.6; Ni 99.2; LC-Ni99.6; LC-Ni99.</b> <b>W.no: 2.4066, 2.4068, 2.4061, 2.4060, 2.4050, 2.4062, 2.4106, 2.4110, 2.4122, 2.4116, 2.4128</b>
<b>CEWELD</b> <b>E NiCu30Mn</b>	<b>9606-1: FM6</b> <b>Sect IX QW-432: F-No. 42</b> <b>14172:</b> E Ni 4060 (NiCu30Mn3Ti) <b>A 5.11:</b> E NiCu-7	T ~ 640 MPa Y > 480 MPa E > 30%	C < 0,15 Mn < 4,0 Fe < 2,5 Si < 1,5 Cu 27 - 34 Ni 62 - 69 Ti < 1,0 Al < 0,75	<b>E NiCu30Mn</b> is suitable for welding Monel Alloys 400, R-405 end K-500. Also suitable for dissimilar welding between Nickel 200-201, stainless steel, carbon steel, Inconel and Incoloy alloys, <b>Nickel Copper</b> and Copper nickel alloys. Also used for surfacing of steel. Shipbuilding, seawater evaporation plants, tubes, pump building, offshore etc. <b>2.4360, 2.4375, NiCu30Fe, NiCu30Al, Monel 400, R405, alloy K500 and dissimilar welding between these alloys.</b>
<b>CEWELD</b> <b>E Nicro HLS</b>	<b>9606-1: ~ FM6</b> <b>Sect IX QW-432: F-No. ~ 43</b> <b>14172:</b> ~E Ni 6082 (NiCr20Mn3Nb) <b>A 5.11:</b> ~E NiCrFe-3	T > 620 MPa Y > 380 MPa E > 35% I > 90J (20 °C) I > 70J (-196 °C)	C 0,03 - 0,06 Mn 4,0 - 6,0 Fe 3,0 - 5,0 Si < 0,8 Ni > 63 Cr 18 - 22 Nb 1,5 - 3,0	<b>E Nicro HLS</b> is a basic electrode well suited for <b>maintenance and repair welding</b> applications in chemical, apparatus and heavy industry. <b>First choice electrode for dissimilar welding</b> of steel to Nickel alloys or repairing high carbon steels and white cast irons. Working temperatures <b>-196 °C up to 650 °C.</b> <b>Incoloy 800, DS - Inconel 600, 601, X8Ni9 - 12Ni19 - 10Ni 14 - NiCr15Fe - NiCr23Fe - X10NiCrAlTi3220 - X10CrNiMoNb18.12 - NiCr20Ti. W.no.:1.5662 - 1.5680 - 1.5637 - 1.6582 - 1.4876 - 1.4583 - 2.4816 - 2.4851 - 2.4951, 2.4806, Alloy 82, 1.4816, 600L, 800H, AISI 4340, 4130, 8630</b>
<b>CEWELD</b> <b>E NiCro A</b>	<b>9606-1: FM6</b> <b>Sect IX QW-432: F-No. 43</b> <b>14172:</b> E Ni 6133 (NiCr16Fe12NbMo) <b>A 5.11:</b> E NiCrFe-2	T > 600 MPa Y > 400 MPa E > 30% I > 100J (20 °C) I > 80J (-196 °C)	C < 0,10 Mn 1,0 - 3,5 Fe < 12 Si < 0,75 Cu < 0,50 Ni > 62 Cr 13 - 17 Nb+Ta 0,5 - 3,0 Mo 0,5 - 2,5	<b>E NiCro A</b> is used for welding <b>nickel-iron-chromium Alloys</b> of INCOLOY Alloys 800 and 800HT, INCONEL Alloys 600 and 601, and nickel steels. They may be used for applications at temperatures up to about <b>980 °C</b> but do not offer optimum oxidation resistance and strength above <b>820 °C.</b> <b>2.4816, 1.4876, 1.4859, 2.4951, 2.4952, NiCr15Fe, X10NiCrAlTi 32 20, G-X10NiCrNiNb 32 20, NiCr20Ti, NiCr20TiAl, Alloy 600/B168, Alloy 800/800H, Alloy 75, Alloy 80A</b>
<b>CEWELD</b> <b>E Nicro 600</b>	<b>9606-1: FM6</b> <b>Sect IX QW-432: F-No. 43</b> <b>14172:</b> E Ni 6182 (NiCr15Fe6Mn) <b>5.11:</b> E NiCrFe-3	T ~ 640 MPa Y > 370 MPa E > 40% I > 100J (20 °C) I > 80J (-196 °C)	C < 0,10 Mn 5,0 - 9,5 Fe < 10 Si < 1,0 Ni > 60 Cr 13 - 17 Nb+Ta 1,0 - 2,5	<b>E Nicro 600</b> electrodes are used for <b>welding of nickel-chromium-iron alloys</b> (Inconel 600, 601 and 690) to themselves, and for <b>dissimilar welding</b> between nickel-chromium-iron (Monel, Inconel and Incoloy) alloys and steels or stainless steels. The applications include surfacing as well as cladding. High manganese of this weld deposit reduces the possibility of micro fissures. High manganese reduces creep strength, which limits its usage <b>up to 480 °C.</b>
<b>CEWELD</b> <b>E Nicro 825</b>	<b>9606-1: FM6</b> <b>Sect IX QW-432: - -</b> <b>14172:</b> E Ni 8165 (NiCr25Fe30Mo) <b>A 5.11: -</b>	T ~ 630 MPa Y > 240 MPa E > 22% I > 70J (-196 °C)	C < 0,03 Mn 1,0 - 3,0 Fe < 30 Si < 0,7 Cu 1,5 - 3,0 Ni 37 - 42 Cr 23 - 27 Mo 3,5 - 7,5	<b>E Nicro 825</b> is used for welding copper-alloyed austenitic stainless chromium-nickel-molybdenum alloys and have excellent corrosion-resistant properties so it make the alloy to a suitable choice for a variety of difficult applications. Uses include fabricated equipment found in chemical and petrochemical processing, pulp and paper manufacturing, flue gas desulphurization systems and metal pickling operations. <b>G-X7NiCrMo20, X1NiCrMoCuN25 20 6, X1NiCrMoCuN25 20 5, NiCr21Mo, X1NiCrMoCu 31 27 4, N08926, N08904, ALLOY 825, N08028, UNS N08825 W.Nr: 1.4500, 1.4529, 1.4539 (904L), 2.4858, 1.4563, 1.4465, 1.4577 (310Mo), 1.4133, 1.4500, 1.4503, 1.4505, 1.4506, 1.4531, 1.4536, 1.4585, 1.4586 CuNb 25</b>
<b>CEWELD</b> <b>E NiCrMo 622</b>	<b>9606-1: FM6</b> <b>Sect IX QW-432: F-No. 43</b> <b>14172:</b> E Ni 6022 (NiCr21Mo13W3) <b>A 5.11:</b> E NiCrMo-10	T > 690 MPa Y > 300 MPa E > 25% I > 100J (20 °C) I > 80J (-196 °C)	C < 0,02 Mn < 1,0 Fe 2,0 - 6,0 Si < 0,2 Ni > 49 Co < 2,5 Cu < 0,5 Cr 20 - 22,5 Mo 12,5 - 14,5 W 2,5 - 3,5	<b>E NiCrMo 622</b> electrodes are used for welding of <b>nickel-chromium-molybdenum alloys</b> as well as for overlay cladding on carbon, low alloy, or stainless steels. They are also used for dissimilar joints between nickel-chromium-molybdenum alloys and stainless, carbon, or low alloy steels. <b>Inconel 622, 625, Alloy 25-6Mo, Incoloy 825, dissimilar joints of Nickel Alloys, Hastelloy Alloy C276, C22, C4, 2.4611, Typical specifications for the Nickel-Chromium-Molybdenum base metals are ASTM, F574, B619, B622 and B626 - All of which have UNS Number N06022.</b>

TYPE	EN -ISO and ASME -AWS	MECHANICAL PROPERTIES	ANALYSIS	APPLICATION
<b>CEWELD E Alloy C-276</b>	<b>9606-1: FM6 Sect IX QW-432: F-No. 43 14172:</b> E Ni 6276 (NiCr15Mo15Fe6W4) 5.11: E NiCrMo-4	T > 690 MPa Y > 400 MPa E > 25% I > 120J (20 °C)	C < 0,02 Mn < 0,1 Fe 4,0 - 7,0 Si < 0,2 Cu < 0,5 Ni > 50 Co < 2,5 Cr 14,5 - 16,5 Mo 15 - 17 W 3,0 - 4,5	<b>E Alloy C-276</b> is used for welding materials of <b>similar composition</b> . This low carbon <b>nickel-chromium-molybdenum</b> alloy can also be used for dissimilar welding <b>between nickel base alloys and stainless steels</b> , as well as for surfacing and cladding on low alloyed steels. <b>Excellent resistance to sulfuric acids at high chloride concentrations as well as strongly oxidizing solutions, e.g. contain iron and copper chlorides.</b> <b>W.no : 2.4819 (NiMo16Cr15W) Hastelloy C276</b>
<b>CEWELD E Alloy B3</b>	<b>9606-1: FM6 Sect IX QW-432: F-No. 43 14172:</b> E Ni 1067 (NiMo30Cr) 5.11: E NiMo-10	T > 700 MPa Y > 400 MPa E > 40% I > 120J (20 °C)	C < 0,02 Mn < 2,0 Fe 1,0 - 3,0 Si < 0,2 Cu < 0,5 Ni > 68 Co < 3,0 Cr 1,0- 3,0 Mo 27 - 32 W < 3,0	<b>E Alloy B3</b> is a nickel-base alloy with excellent resistance tot Hydrochlorid acid at all concentrations and temperatures. It also withstands hydrogen chloride, sulfuric, acetic, hydrofluoric and phosphoric acids. The alloy has improved thermal stability, fabricability and stress corrosion cracking resistance <b>Hastelloy B2, Hastelloy B3, dissimilar welding Hastelloy to nickel- of Iron-based corrosion Alloys, for weld overlay cladding</b>
<b>CEWELD E Alloy HX</b>	<b>9606-1: FM6 Sect IX QW-432: F-No. 43 14172:</b> E Ni 6002 (NiCr22Fe18Mo) 5.11: E NiCrMo-2	T > 690 MPa Y > 400 MPa E > 25% I > 120J (20 °C)	C 0,05 - 015 Mn < 1,0 Fe 17,0 - 20 Si < 1,0 Cu < 0,5 Ni > 45 Co 0,5 - 2,5 Cr 20,0 - 23,0 Mo 8,0 - 10,0 W 0,2 - 1,0	<b>E Alloy HX</b> is a High temperature-resistant solid-solution-strengthened alloy with higher mechanical properties and good oxidation resi-stance up to 1095°C. Applications in gas turbines and industrial furnaces. Because of its good resistance to stress corrosion cracking,also used in the petrochemical industry. <b>Hastelloy X and Similar Alloys</b>
<b>CEWELD E NiCro 625 HLS</b>	<b>9606-1: FM6 Sect IX QW-432: F-No. 43 14172:</b> E Ni 6625 (NiCr22Mo9Nb) A 5.11: E NiCrMo-3	T > 760 MPa Y > 450 MPa E > 30% I > 75J (20 °C) I > 60J (-196 °C)	C < 0,10 Mn < 1,0 Fe < 7,0 Si < 0,75 Ni > 55 Cr 20 - 23 Nb+Ta 3,15 - 4,15 Mo 8,0 - 10 Cu < 0,5	<b>E Nicro 625 HLS</b> is a high recovery <b>type (170%)</b> that guarantees optimum deposit rate and metallurgical quality with attractive weld <b>appeal in the PA-PB position</b> . Very good resistance against pitting corrosion and crevice corrosion. Very good resistance against acid, neutral or alkaline media, with or without chlorides. Very good resistance at <b>high temperatures of about 540°C</b> , especially against oxidation. <b>X10NiCrAlTi, 32-20H, 32-21, X8 Ni9, ASTM A 533 Gr1, 800H, Sanicro 28, 254SMo, Inconel 625, UNS : N08926, N08825, N06625. DIN : X8Ni9, X1NiCrMoCuN25 20 6, X1NiCrMoCuN25 20 5, NiCr21Mo, NiCr22Mo9Nb</b> <b>W.no: 1.4876, 1.5656, 1.4529, 2.4858, 2.4856, 1.4539, 1.4547</b>
<b>CEWELD E NiCro 625</b>	<b>9606-1: FM6 Sect IX QW-432: F-No. 43 14172:</b> E Ni 6625 (NiCr22Mo9Nb) A 5.11: E NiCrMo-3	T > 760 MPa Y > 450 MPa E > 30% I > 75J (20 °C) I > 60J (-196 °C)	C < 0,10 Mn < 1,0 Fe < 7,0 Si < 0,75 Ni > 55 Cr 20 - 23 Nb+Ta 3,15 - 4,15 Mo 8,0 - 10 Cu < 0,5	<b>E Nicro 625</b> is developed for <b>welding and cladding nickel-based alloys such as alloy 625 (Inconel 112) or similar materials</b> . This alloy can also be used for welding dissimilar nickel-based alloys to each other, to alloyed steels, to stainless steels <b>and for joining 9% Nickel steels. Temperatures up to 540 °C.</b> <b>X10NiCrAlTi, 32-20H, 32-21, X8 Ni9, ASTM A 533 Gr1, 800H, Sanicro 28, 254SMo, Inconel 625, UNS : N08926, N08825, N06625, N08002. DIN : X8Ni9, X1NiCrMoCuN25 20 6, X1NiCrMoCuN25 20 5, NiCr21Mo, NiCr22Mo9Nb W.Nr.: 1.4876, 1.5656, 1.4529, 2.4858, 2.4856, 1.4539, 1.4547, 2.4660</b>



## 1 STICK ELECTRODES

TYPE	EN -ISO and ASME -AWS	MECHANICAL PROPERTIES	ANALYSIS	APPLICATION
<b>CEWELD E NiCrMo 686 CPT</b>	<b>9606-1: FM6 Sect IX QW-432: F-No. 43 14172:</b> E Ni 6686 (NiCr21Mo16W4) <b>A 5.11:</b> E NiCrMo-14	T > 690 MPa Y > 350 MPa E > 30%	C < 0,10 Mn < 1,0 Fe < 5,0 Si < 0,25 Ni > 49 Ti < 0,3 Cr 19 - 23 Mo 15 - 17 W 3,0 - 4,4	<b>E NiCrMo 686 CPT</b> electrode is suitable for welding <b>duplex, super-duplex and super-austenitic stainless steels</b> as well as <b>nickel-chromium-molybdenum alloys</b> such as UNS N06059 and N06022, Inconel alloy C-276 and Inconel alloys 622, 625 and 686. <b>Joining Duplex, Superduplex, super austenitic stainless steel, nickel alloys, N06059, N06022, Hastelloy C276, alloy C22, Inconel 622, 625, 686, chemical and petrochemical industry, 2.4605, 2.4610, 2.4602, 2.4819, NiCr23Mo16Al, Ni-Mo16Cr15Ti, NiCr21Mo14W, NiMo16Cr15W, alloy 59, alloy C4, alloy 276</b>
<b>CEWELD E NiCrCo 617</b>	<b>9606-1: FM6 Sect IX QW-432: F-No. 43 14172:</b> E Ni 6117 (NiCr22Co12Mo) <b>A 5.11:</b> E NiCrCoMo-1	T > 620 MPa Y > 400 MPa E > 25% I > 120J (20 °C)	C 0,05 - 0,15 Mn 0,3 - 2,5 Fe < 5,0 Si < 0,75 Ni > 45 Co 9,0 -15 Cu < 0,5 Cr 21 - 26 Nb+Ta < 1,0 Mo 8,0 -10	<b>E NiCrCo 617</b> is used for welding of <b>nickel-chromium-cobalt-molybdenum alloys</b> (UNS Number N06617). <b>This electrode can also be used for overlay cladding</b> in case its alloy properties are required. Weld metal provides optimum strength and oxidation <b>resistance above up to 1150 °C</b> , especially when welding on base metals of nickel-iron-chromium alloys. <b>Inconel alloys 600 and 601, Incoloy alloys 800 HT and 802 and cast alloys such as HK-40, HP and HP-45 Modified. UNS Number N06617, 2.4663, 1.4952, 1.4958, 1.4959, NiCr21Co12Mo, X6CrNiNbN 25 20, X5NiCrAlTi 31 20, X8NiCrAlTi 32 21, Alloy 617, N08810, N08811</b>
<b>12. SHOCK AND ABRASION RESISTANT</b>				
<b>CEWELD E DUR 300 Kb</b>	<b>14700:</b> E Fe1 (DIN 8555: E 1-UM-300-P)	320 HB <b>(up from 3rd layer)</b> 300 HB <b>(up from 2nd layer)</b> 280 HB <b>(up from 1st layer)</b> (275-325HB)	C ~ 0,1 Mn ~ 1,0 Si ~ 0,5 Cr ~ 1,2 Fe Rest	<b>E DUR 300 Kb</b> is an exceptional easy to apply alloy <b>without any risk for cracks</b> and can also be applied on austenitic manganese steels, <b>300 HB</b> is usually almost obtained in the first layer. The weld deposit is machinable with tungsten carbide tool tips. Very good weld deposit appearance and outstanding <b>welding properties on both AC and DC+</b> .
<b>CEWELD E DUR 350 Kb</b>	<b>14700:</b> E Fe1 (DIN 8555: E 1-UM-350-P)	370 HB <b>(up from 3rd layer)</b> 350 HB <b>(up from 2nd layer)</b> 320 HB <b>(up from 1st layer)</b> (325-375HB)	C ~ 0,15 Mn ~ 1,1 Si ~ 0,7 Cr ~ 3,0 Fe Rest	<b>E DUR 350 Kb</b> is an exceptional easy to apply alloy <b>without any risk for cracks</b> and can also be applied on austenitic manganese steels, <b>350 HB</b> is usually almost obtained in the first layer. The weld deposit is machinable with tungsten carbide tool tips. Very good weld deposit appearance and outstanding <b>welding properties on both AC and DC+</b> .
<b>CEWELD E DUR 400 Kb</b>	<b>14700:</b> E Fe1 (DIN 8555: E 1-UM-400-P)	420 HB <b>(up from 3rd layer)</b> 400 HB <b>(up from 2nd layer)</b> 375HB <b>(up from 1st layer)</b> (375-450HB)	C ~ 0,18 Mn ~ 1,2 Si ~ 0,7 Cr ~ 3,5 Fe Rest	<b>E DUR 400 Kb</b> is an exceptional easy to apply alloy <b>without any risk for cracks</b> and can also be applied on austenitic manganese steels, <b>400 HB</b> is usually almost obtained in the first layer. The weld deposit is machinable with tungsten carbide tool tips. Very good weld deposit appearance and outstanding <b>welding properties on both AC and DC+</b> .
<b>CEWELD E DUR 400 CrMo</b>	<b>14700:</b> E Fe3 (DIN 8555: E 3-UM-40-PT)	42 HRC <b>(up from 3rd layer)</b> 39 HRC <b>(up from 2nd layer)</b> 36 HRC <b>(up from 1st layer)</b> (37-42HRC)	C ~ 0,1 Mn ~ 0,6 Si ~ 0,4 Cr ~ 6,5 Mo ~ 3,0 Fe Rest	<b>E DUR 400 CrMo</b> is an exceptional easy to apply alloy <b>without any risk for cracks</b> and can also be applied on austenitic manganese steels, 39 HRC is usually almost obtained in the first layer. The weld deposit has a high impact resistance combined with abrasion resistance, including metal to metal friction resistance, and increased <b>working temperatures up to 550°C</b> .
<b>CEWELD E DUR 600 Kb</b>	<b>14700:</b> E Fe8 (DIN 8555: E 6-UM-60)	57-62 HRC	C ~ 0,5 Mn < 3,0 Cr ~ 9,0 Mo < 5,0 V < 2,0 W < 2,0 Nb < 1,0 Fe Rest	<b>E DUR 600 Kb</b> is a <b>basic coated</b> electrode with <b>approximately 130% recovery</b> that results in a <b>fine rippled seam</b> surface with <b>excellent impact and wear properties</b> . The weld deposit shows a martensitic structure with good high temperature properties and can <b>resist oxidation up to 800°C</b> . The deposit is heat treatable and offers excellent sliding and rolling properties.
<b>CEWELD E DUR 600 AC</b>	<b>14700:</b> E Fe8 (DIN 8555: E6-UM-60-GP)	57-62 HRC	C ~ 0,7 Mn ~ 0,5 Si ~ 1,9 Cr ~ 10,0 Fe Rest	<b>E DUR 600 AC</b> electrode has a <b>soft but intensive welding character</b> , a fine-structured seam surface and <b>excellent slag-removal</b> properties. Suitable for : Rollers, dredger chains, conveyors, hammers, dredger equipment, mining and earth-moving equipment. Can be welded on current DC+ and AC
<b>13. HIGH WEAR RESISTANT</b>				
<b>CEWELD E DUR 55</b>	<b>Sect IX QW-432: F-No. 71 14700:</b> E Fe7 (DIN 8555: E3-UM-50-CKRTZ ) <b>A 5.13:</b> E FeCr-A1	48-50 HRC	C ~ 4,5 Si ~ 1,0 Mn ~ 1,0 Cr ~ 25 Fe Rest	<b>E DUR 55</b> is a <b>heavy coated high efficiency</b> hardfacing electrode with <b>160 % recovery</b> . Suitable for applications subject to <b>strong abrasive wear by minerals</b> .



TYPE	EN -ISO and ASME -AWS	MECHANICAL PROPERTIES	ANALYSIS	APPLICATION
CEWELD E DUR 60	Sect IX QW-432: F-No. 71 14700: E Fe14 (DIN 8555: E10-UM-60) A 5.13: ~E FeCr-A1A	57-62 HRC	C ~ 3,8 Si ~ 0,6 Mn ~ 0,6 Cr ~ 30,0 Fe Rest	<b>E DUR 60</b> offers weld deposits for wear resistant hardfacing layers that are subject to <b>high abrasion and medium impact</b> .  Base materials: mild steels, low alloyed steels, cast steels and high manganese steels.
CEWELD E DUR 60 Kb	Sect IX QW-432: F-No. 71 14700: E Fe8 (DIN 8555: E6-UM-60) A 5.13: ~E Fe3	57-62 HRC	C ~ 0,6 Si ~ 0,5 Mn ~ 0,6 Cr ~ 9,0 Mo ~ 0,8 V ~ 1,0 Fe Rest	<b>E DUR 60 Kb</b> offers weld deposits against high <b>impact combined with abrasion including metal to metal friction</b> . The weld deposit of DUR E 60 Kb is one of the most universal alloys in <b>hardfacing applications and can also be applied on austenitic manganese steels</b> . Very good weld deposit appearance and outstanding welding properties on <b>both AC and DC+</b> .
CEWELD E DUR 62 S	Sect IX QW-432: F-No. 71 14700: E Fe15 (DIN 8555: E 10-UM-65-GRZ) A 5.13: ~E FeCr-A8	62-67 HRC	C ~ 4,4 Ni ≤ 1 Mn ≤ 1 Cr ~ 33,0 Mo ≤ 1 Fe Rest	<b>E DUR 62 S</b> is an extreme <b>abrasion resistant</b> hardfacing alloy offering excellent wear resistance with medium impact. Outstanding alloy against high abrasion when <b>subjected to grinding and medium impact</b> levels. Very good weld deposit appearance and outstanding welding properties on <b>both AC and DC+ with a recovery of 200%</b> for excellent deposit performance.
CEWELD E DUR 63 Nb	Sect IX QW-432: F-No. 71 14700: E Fe15 (DIN 8555: E 10-UM-65-GRZ) A 5.13: ~E FeCr-E4	61-65 HRC (up from 3rd layer) 59-62 HRC (up from 2nd layer) 57-60 HRC (up from 1st layer)	C ~ 5,5 Si ~ 0,9 Mn ≤ 3 Cr ~ 23,5 Mo ≤ 2 Nb ~ 6,0 Fe Rest	<b>E DUR 63 Nb</b> is very economical ( <b>recovery of 190%</b> ) due to the <b>high deposition</b> rate and excellent weldability without slag losses. For critical base material or old hard facing layers it is necessary to buffer with an electrode like DUR E 350 Kb / E 11018-G that delivers a welding deposit of a lower hardness. Maximum working temperature up to <b>450 °C</b> .
CEWELD E DUR CE- Tube 62	Sect IX QW-432: F-No. 71 14700: ~E Fe15 (DIN 8555: E 10-UM-60-GZ) A 5.13: ~E FeCr-A7	58-63 HRC (up from 3rd layer) 54-59 HRC (up from 2nd layer) 50-54 HRC (up from 1st layer)	C ~ 4 Mo ~ 2,0 Cr ~ 25,0 B ~ 1,7 V ~ 0,6	<b>E DUR CE-Tube 62 tubular stick electrode</b> with its <b>extreme recovery</b> offers excellent wear resistance in high velocity, fine particle applications in which erosive wear is a major problem. <b>Further to be used against high general wear and medium impact</b> .
CEWELD E DUR 64	Sect IX QW-432: F-No. 71 14700: E Fe16 (DIN 8555: E 10-UM-65-GTZ) A 5.13: E FeCr-E4	63-66 HRC / 20 °C 40-45 HRC / 600 °C	C ~ 5,5 Cr ~ 24 Mn ~ 0,6 Mo ~ 6,0 W ~ 2,0 V ~ 1,0 Nb ~ 6,0 Fe Rest	<b>E DUR 64</b> is very economical ( <b>recovery of 190%</b> ) due to the <b>high Mo-content</b> , extreme abrasion resistance with moderate impact can be kept up to working temperatures of <b>600 °C</b> , the Ledeburitic weld metal structure it offers a hardness of <b>40-45 HRC</b> at these temperatures. <b>For hardfacing of more than 3 layers it is necessary to buffer with an electrode such as DUR E 350 Kb</b> .
CEWELD E DUR 68 T	Sect IX QW-432: F-No. 71 14700: ~E Fe14 (DIN 8555: E 10-UM-70-GTRZ) A 5.13: ~E FeCr-A8	≥ 67 HRC	C ~ 4,5 Ni ≤ 4,0 Mn ~ 0,5 B ~ 1,0 Cr ~ 32,0 Fe Rest	<b>E DUR 68 T</b> is a <b>thick coated</b> electrode with high <b>recovery 200%</b> . Ledeburitic weld metal structure. Applicable for parts that are exposed to strong abrasive wear with low impact. Applicable for working temperatures up to <b>300 °C</b> .

## 14. FOR FERRITIC &amp; MARTENSITIC STAINLESS STEEL

CEWELD 4009 Ti	9606-1: FM5 Sect IX QW-432: F-No. 1 3581-A: E 13 B 42 A 5.4: E 410-26	T > 650 MPa Y > 450 MPa E > 15% ~ 180 HB	C < 0,12 Si < 0,9 Mn < 1,0 Cr 11 - 13,5 Ni < 0,6 Mo < 0,75	<b>4009 Ti</b> can be used for <b>welding martensitic-ferritic steels</b> , steel castings and for hardfacing exhaust valves. <b>Steel W.no. 1.4000,1.4002, 1.4006, 1.4024, 1.4024.</b> Working temperature <b>up to 450 °C</b> , recommended <b>preheat temperature is 200 °C</b> unless base material requires a higher preheat temperature. Use DC+ polarity.
CEWELD 4015 HL-Kb	9606-1: FM5 Sect IX QW-432: F-No. 1 3581-A: E 17 B 42 A 5.1: E 430-26	~ 180 HB AW ~ 150 HB SR	C < 0,10 Si < 0,9 Mn < 1,0 Cr 16 - 18 Ni < 0,6 Mo < 0,75	<b>4015 HL-Kb</b> can be used for <b>joining and cladding 17% Chromium alloys</b> and cladding components where heat and corrosion resistance is required. The weld deposit can sustain <b>working temperatures up to 450 °C</b> and will offer scale <b>resistance up to 950 °C</b> . <b>Preheating is recommended at 250 °C and stress relieving at 800 °C</b> in case it is allowed for the base metal. <b>Steel W.no. 1.4057,1.4740, 1.4742, 1.4059,1.4741</b>

## 1 STICK ELECTRODES

TYPE	EN -ISO and ASME -AWS	MECHANICAL PROPERTIES	ANALYSIS	APPLICATION
<b>15. STELLITE ( COBALT BASED ALLOYS)</b>				
<b>CEWELD E DUR 1U</b>	<b>Sect IX QW-432:</b> F-No. 71 <b>14700:</b> E Co3 (DIN 8555: E 20-UM-55-CTZ ) <b>A 5.13:</b> E CoCr-C	52-57 HRC	C ~ 2,4 Mn ~ 0,4 Si ~ 0,7 W ~ 11,0 Co Rest Cr ~ 30,0 Fe < 3,0	<b>E DUR 1U</b> is a <b>cobalt-based thermo shock resistant</b> alloy for overlay applications. Steam-valves, high temperature liquid pumps, Hot cutting blades, exhaust valves.
<b>CEWELD E DUR 6U</b>	<b>Sect IX QW-432:</b> F-No. 71 <b>14700:</b> E Co2 (DIN 8555: E 20-UM-40-CTZ ) <b>A 5.13:</b> E CoCr-A	37- 42 HRC	C ~ 1,1 Mn ~ 0,6 Si ~ 1,0 W ~ 4,5 Co Rest Cr ~28,0 Fe < 5,0	<b>E DUR 6U</b> has excellent welding properties and self detaching slag. The weld deposit can be machined with tungsten carbide tool tips and by grinding. The hardness of the weld deposit will decrease with 16% at 300°C and about 30% at 600 °C( around 28 HRC). <b>The weld deposit is high heat resistant up to 900 °C.</b>
<b>CEWELD E DUR 12U</b>	<b>Sect IX QW-432:</b> F-No. 71 <b>14700:</b> E Co3 (DIN 8555: E20-UM-50-CSTZ ) <b>A 5.13:</b> E CoCr-B	47- 52 HRC	C ~ 1,4 Mn ~ 0,1 Si ~ 0,8 W ~ 8,0 Co Rest Cr ~ 29,0 Fe < 2,5	<b>E DUR 12U</b> is a <b>cobalt-based thermo shock resistant</b> alloy for overlay applications. Steam-valves, high temperature liquid pumps, hot cutting tools, cutting tools for plastic, wood and paper as well as high stressed sealing's and sliding surfaces.
<b>CEWELD E DUR 21U</b>	<b>Sect IX QW-432:</b> F-No. 71 <b>14700:</b> E Co1 (DIN 8555: E 20-UM-350-CTZ ) <b>A 5.13:</b> E CoCr-E	325-375 HB	C ~ 0,3 Mn ~ 1,0 Si ~ 0,9 Co Rest Cr ~ 28,0 Fe ~ 3,0 Ni ~ 3,0 Mo ~ 5,5	<b>E DUR 21U</b> is able to <b>create a Stellite 21</b> alloy layer for cladding seats and valves etc. <b>low friction</b> due to high cobalt content.
<b>CEWELD E DUR 25U</b>	<b>14700:</b> ~E Co1 (DIN 8555: E 20-UM-300-CTZ )	275 - 325 HB	C ~ 0,1 Mn ~ 2,0 Cr ~ 20,0 Ni ~ 10,0 Mo ~ 1,0 W ~ 15,0 Co Rest Fe ~ 3,0	<b>E DUR 25U</b> is a cobalt based electrode and developed to <b>resist high impact load, high heat, thermal shock, hot corrosion</b> , compression, abrasion, erosion and many other forms of attack. The weld deposit is machinable with carbide tools.
<b>16. FOR CUTTING EDGES - TOOL STEEL</b>				
<b>CEWELD E DUR SS 60Ti</b>	<b>Sect IX QW-432:</b> F-No. 71 <b>14700:</b> E Fe4 (DIN 8555: E4-UM-60-ST ) <b>A 5.13:</b> ~E Fe6	58-62 HRC <b>(AW)</b> 63-65 HRC <b>(annealed 530°C)</b> 250 HB <b>(soft annealed 810°C)</b> 60-63 HRC <b>(hardened 1220°C)</b>	C ~ 0,9 Cr ~ 5,0 Mo ~ 8,0 W ~ 2,0 V ~ 1,5 Fe Rest	<b>E DUR SS 60 Ti</b> can be used against abrasion, impact and <b>high temperatures up-to 550 °C</b> . The weld deposit of <b>DUR SS 60Ti</b> is more or less comparable with HSS (High Speed Steel) and will offer outstanding welding properties on <b>both AC and DC+</b> Recommended for manufacturing and reconditioning cutting tools / edges.
<b>17. MANGANESE BASED</b>				
<b>CEWELD E DUR Mn14</b>	<b>Sect IX QW-432:</b> F-No. 71 <b>14700:</b> E Fe9 (DIN 8555: E 7-UM-250-K) <b>A 5.13:</b> E FeMn-A	225-275 HB 440 HB <b>(work hardened)</b>	C ~ 0,8 Mn ~ 13,5 Ni ~ 3,0 Fe Rest	<b>E DUR Mn14</b> has <b>no limit for the number of layers</b> that can be applied in case of rebuilding, however the heat input should be kept low (as for Mn steel). The weld deposit offers <b>strain hardening properties from 250 till 440 HB</b> .
<b>CEWELD E DUR MnCr</b>	<b>Sect IX QW-432:</b> F-No. 71 <b>14700:</b> E Fe9 (DIN 8555: E 7-UM-250-K) <b>5.13:</b> E FeMnCr	225-275 HB 450 HB <b>(work hardened)</b>	C ~ 0,75 Mn ~ 17,5 Si ~ 0,4 Cr ~ 16,0 Fe Rest	<b>E DUR MnCr</b> has <b>no limit for the number of layers</b> that can be applied in case of rebuilding, however the heat input should be kept low <b>(as for Mn steel, should be kept &lt; 250 °C)</b> .

TYPE	EN -ISO and ASME -AWS	MECHANICAL PROPERTIES	ANALYSIS	APPLICATION
<b>18. TUNGSTEN CARBIDE ALLOY</b>				
<b>CEWELD E DUR R</b>	<b>14700:</b> E Fe20 (DIN 8555 E21-GF-UM-60-GP)	58-62 HRC Matrix > 2000 HV Karbid	C ~3,7 WSC Rest Fe ~40	<b>E DUR R</b> has a core wire filled with fused tungsten carbides. The weld deposit contains a high amount of tungsten carbides embedded in a steel matrix. The extraordinary hardness of the fused tungsten carbides (WSC) of approx. 2000-2300 HV results in a high build-up wear resistance. <b>DUR R</b> is a dip-coated electrode suitable for welding on AC as well as on DC+. The carbon content of the base metal should not exceed 0,45 % in order to avoid lack of fusion.
<b>CEWELD E DUR RU (Ni)</b>	<b>14700:</b> E Ni20 (DIN 8555 E21-GF-UM-60-GP)	50-65 HRC Matrix 1700-3100 HV Karbid	C ~3,5 WSC Rest Ni ~ 35 B ~1,1	<b>E DUR RU Ni</b> has a NiCrBSi based core wire filled with fused tungsten carbides. A newly designed hard-surfacing product consisting of crushed tungsten carbide and a Ni-based alloy. Crushed cast carbide will guaranty a long service life. Furthermore the Ni-based alloy provides an excellent corrosion resistance.
<b>CEWELD E DUR CE- Tube WC2</b>	<b>14700:</b> E Fe20 (DIN 8555 E21-GF-UM-65-GZ)	61-64 HRC <b>(up from 1st layer)</b> 65-70 HRC <b>(up from 2nd layer)</b>	Cr ~ 12 WSC ~ 52	<b>E DUR CE-Tube WC2</b> is due to the <b>complex carbide combination of Cobalt, Chromium, Aluminium, Zirconium and a extreme high Tungsten content</b> the ultimate wear resistance alloy. The abrasion resistance is <b>4 till 8 times better in comparison with C-Cr. alloys</b> . Hardfacing knowledge is based on practical experience and years of testing many different procedures and alloys
<b>19. FOR ALUMINIUM AND ALUMINIUM ALLOYS</b>				
<b>CEWELD E AI 99,8</b>	<b>Sect IX QW-432 : F-No. 21 18273:</b> E AI 99,0Cu (DIN 1732: EL-AI 99,8 ) <b>A 5.3:</b> E 1100	T > 80 MPa Y > 40 MPa E > 25%	Al > 99 Cu 0,05-0,2 Mn ~ 0,05 Zn ~ 0,10 Si+Fe < 0,95	<b>E AI99,8</b> is designed for <b>joining pure aluminum</b> and alloys with <b>maximum 0,5 % alloying</b> elements in construction and or in maintenance, also <b>ideal for cladding or rebuilding parts. Can be used for flame welding as well.</b>
<b>CEWELD E AISi5</b>	<b>Sect IX QW-432: F-No. 23 18273:</b> E AISi5 (A) (DIN 1732: EL-AISi 5) <b>A 5.3:</b> E 4043	T ~ 230 MPa Y ~ 150 MPa E > 18%	Al Rest Si 4,5 - 6,0 Fe ~ 0,8 Cu ~ 0,3 Mn ~ 0,05 Mg ~ 0,05 Zn ~ 0,10 Ti ~ 0,20	<b>E AISi5</b> offers a very good weldability with good penetration and <b>porosity free deposits</b> . Unique <b>self lifting slag</b> and improved coating against moisture pick up. (after anodizing the welding will appear as a <b>dark grey color</b> ).
<b>CEWELD E AISi12</b>	<b>Sect IX QW-432: F-No. 21 18273:</b> E AISi12 (A) (DIN 1732: EL-ALSi12)	T ~ 250 MPa Y ~ 150 MPa E ~ 14%	Al Rest Si 11 - 13 Fe ~ 0,6 Cu ~ 0,3 Mn ~ 0,15 Mg ~ 0,10 Zn ~ 0,20 Ti ~ 0,15	<b>E AISi12</b> is suitable for <b>joining aluminum alloys</b> such as broken gear parts and or other casting parts, also ideal for <b>cladding or rebuilding</b> worn-out parts.
<b>CEWELD E AIMn1</b>	<b>Sect IX QW-432: F-No. 21 18273:</b> E AIMn1Cu (DIN 1732: EL-ALMn1) <b>A 5.3:</b> E 3003	T ~ 152 MPa Y ~ 145 MPa E ~ 8%	Al Rest Si ~ 0,3 Fe ~ 0,35 Cu 0,05- 0,2 Mn 1,0 - 1,5 Zn ~ 0,05	<b>E AIMn1</b> is suitable for <b>joining aluminum alloys</b> such as broken parts and or other casting parts, also ideal for <b>cladding or rebuilding parts</b> . Aluminum alloyed with Manganese, copper, silicon, and magnesium. Also <b>excellent for welding dissimilar grades of Aluminum</b> . Storage tanks, truck and trailer parts, chemical tanks, food equipment.
<b>20. ALUMINIUM BRONZE</b>				
<b>CEWELD E CuAl8</b>	<b>Sect IX QW-432: F-No. 31 17777:</b> E Cu 6100A - CuAl9 (DIN 1733: EL CuAl8) <b>A 5.6:</b> ~ER CuAl-A1 UNS C61000	180 HB T > 420 MPa Y > 180 MPa E > 20%	Cu Rest Zn - Mn < 2,0 Fe < 1,0 Si < 0,7 Al 6,5-8,5 Pb < 0,02 other < 0,50	<b>E CuAl8</b> is designed for <b>joining steel with copper</b> or its alloys and cladding steel, brass or aluminum bronze.
<b>CEWELD E CuMnAlNi</b>	<b>Sect IX QW-432: F-No. 37 17777:</b> E Cu 6338 - CuMn13Al- 7Fe3Ni2 (DIN 1733: EL CuMn14Al ) <b>A 5.6:</b> E CuMnNiAl UNS C63380	200-230 HB T > 520 MPa E > 20%	Cu Rest Al 6,0 - 8,5 Fe 2,0 - 4,0 Mn 11 - 14 Ni+Co 1,5 - 3,0 Si < 1,5	<b>E CuMnAlNi</b> is designed for <b>welding and overlaying of almost all bronzes</b> but can also be used on cast iron and most kind of steels. Due to the high tensile strength and the very good sliding properties it is often used for surfacing of shafts, ship propellers, bearings, dies etc...

## 1 STICK ELECTRODES

TYPE	EN -ISO and ASME -AWS	MECHANICAL PROPERTIES	ANALYSIS	APPLICATION
<b>21. FOR TIN BRONZE</b>				
<b>CEWELD E ZIBRO</b>	<b>Sect IX QW-432:</b> F-No. 33 <b>17777:</b> E Cu 5180B - CuSn7 (DIN 1733: EL CuSn7) <b>A 5.6:</b> E CuSn-C UNS C52100	120 HB T > 280 MPa Y > 120 MPa E > 20%	Cu Rest Al < 0,1 Fe < 0,2 Si < 0,5 Sn 7 - 8 Zn < 0,20	<b>E Zibro</b> is suitable for welding and overlaying copper and copper alloys, phosphor- and tin-bronzes and copper blades in mechanical and plant engineering and also for shipbuilding
<b>22. COPPER BASED ELECTRODE</b>				
<b>CEWELD E CuMn</b>	<b>Sect IX QW-432:</b> F-No. 31 <b>17777:</b> ECu 1893 - CuMn2 <b>A 5.6:</b> ~ ERCu UNS C18980	100 HB T > 205 MPa E > 20%	Cu > 95 Fe < 1,0 Mn 1,0-3,0 Ni+Co < 0,3 P < 0,10 Si < 0,8	<b>E CuMn</b> suitable for welding and overlaying copper and copper alloys, Cast Iron and steel. Cladding steel, grey cast iron, copper, copper alloys and dissimilar welding. <b>W.no: 2.0040, 2.0070, 2.0076, 2.0090. UNS: C10100, C11000, C10300, C11020, C12200</b>
<b>CEWELD E CuNi30Mn</b>	<b>Sect IX QW-432:</b> F-No. 34 <b>17777:</b> E Cu 7158 (CuNi30Mn1F-eTi) (DIN 1733: EL-CuNi30Mn) <b>A 5.6:</b> E CuNi UNS C71581	200-230 HB T > 350 MPa E > 20%	Cu Rest Fe 0,4 - 0,75 Si < 0,25 Mn < 1,0 Ni+Co 29 - 32 Ti 0,2-0,5	<b>E CuNi30Mn</b> is a copper-nickel based stick electrode and has an <b>excellent corrosion resistance in seawater</b> and resistance against fouling. Suitable for dissimilar welding of Monel alloy 450 to Nickel 200 and or other Copper -Nickel alloys. Small diameters can be used in all positions. <b>(Monel 67): Wrought and Cast Alloys of 70-30, 80-20 and 90-10 Copper Nickel Alloys, Monel Alloy 450, Nickel 200, CuNi10Fe, CuNi20Fe (2.0878), CuNi30Fe (2.0882)</b>
<b>23. FOR CAST IRON</b>				
<b>CEWELD E GGG</b>	<b>9606: (ISO 15608 W71-76)</b> <b>1071:</b> E C FeC-2-7 (DIN 8573: E (FeC-2) BG 49 ) <b>A 5.15:</b>	max. 270 HB T > 270 MPa	C 3,0 - 3,6 Si 2,0 - 3,5 Mn < 0,8 Al < 3,0 Fe Rest	<b>E GGG</b> is <b>nickel free</b> for color matching grey cast Iron. Repair of non invisible blow holes etc.
<b>CEWELD E GGG L</b>	<b>9606: (ISO 15608 W71-76)</b> <b>1071:</b> E C St 1 (DIN 8573: ~ Fe1 / S21 ) <b>A 5.15:</b> ~E St	160-200 HB	C < 0,15 Si < 1,0 Mn < 0,8 Cu < 0,35 Fe Rest	<b>E GGG L</b> is <b>Nickel free</b> for color matching grey cast Iron. Repair of non invisible blow holes etc.
<b>CEWELD E Ni</b>	<b>9606: (ISO 15608 W71-76)</b> <b>1071:</b> E C Ni-CI-1 (DIN 8573: E Ni-BG 13) <b>A 5.15:</b> E Ni-CI	160 HB T > 300 MPa	C < 2,0 Si < 4,0 Mn < 2,5 Fe < 8,0 Ni > 85 Cu < 2,5 Al < 1,0	<b>E Ni</b> have excellent welding properties with <b>easily controllable flow</b> that results in spatter free welding with very low current. Due to the very low heat input and unique composition of E Ni the transition zone will stay well machinable and is therefore well suited to use as first layer in case off multi-layer welding. <b>The weld metal will show no undercut.</b>
<b>CEWELD E Ni(-)</b>	<b>9606: (ISO 15608 W71-76)</b> <b>1071:</b> E C Ni-CI-1 (DIN 8573: E Ni-BG 22) <b>A 5.15:</b> E Ni-CI	160 HB	C < 2,0 Si < 4,0 Mn < 2,5 Fe < 8,0 Ni > 85 Cu < 2,5 Al < 1,0	<b>E Ni(-)</b> Excellent welding properties with easily controllable flow permits spatter free welding with very low current. Due to the very low heat input and unique composition of Ni(-) the transition zone will stay well machinable and is therefore well suited to use as first layer in case off <b>multi-layer welding.</b>
<b>CEWELD E FeNi 60 N</b>	<b>9606: (ISO 15608 W71-76)</b> <b>1071:</b> E C NiFe-1 (DIN 8573: E NiFe-1-BG 23) <b>A .15:</b> E NiFe-CI	~ 200 HB T 380 - 480 MPa	C < 2,0 Si < 4,0 Mn < 2,5 Fe Rest Ni 45 - 75 Cu < 4,0 Al < 1,0	<b>E FeNi 60 N</b> is suitable for <b>welding grey and malleable cast iron</b> , equally suitable for SG iron. Use this type in case a high tensile strength is required or because of its non conductive coating to <b>weld in difficult welding positions</b> where coating contact is unavoidable with the base metal.
<b>CEWELD E NiFe2</b>	<b>9606: (ISO 15608 W71-76)</b> <b>1071:</b> E C NiFe-CI (DIN 8573: NiFe-1-BG 23) <b>A 5.15:</b> E NiFe-CI	~ 190 HB T 380 - 480 MPa	C < 2,0 Si < 4,0 Mn < 2,5 Fe Rest Ni 45 - 60 Cu < 2,5 Al < 1,0	<b>E NiFe2</b> is suitable for <b>welding grey and malleable cast iron</b> , equally suitable for SG iron. Use this type in case a high <b>tensile strength</b> is required or because of its non overheating coating. <b>Also suitable for joining steel to cast iron!</b>
<b>CEWELD E NiFe 60/40 K</b>	<b>9606: (ISO 15608 W71-76)</b> <b>1071:</b> E C NiFe-CI (DIN 8573: E NiFe-1-BG 11) <b>A .15:</b> E NiFe-CI	190 HB T ~ 500 MPa Y ~ 350 MPa E ~ 10%	C < 2,0 Si < 4,0 Mn < 2,5 Fe Rest Ni 45 - 60 Cu < 2,5 Al < 1,0	<b>E NiFe 60/40 K</b> is suitable for welding grey and malleable cast iron, equally suitable for SG iron. <b>Use this type in case a high tensile strength is required and due to the special coating to weld in difficult welding positions.</b>

TYPE	EN -ISO and ASME -AWS	MECHANICAL PROPERTIES	ANALYSIS	APPLICATION
------	-----------------------	-----------------------	----------	-------------

## 24. FOR GOUGING AND CUTTING

<b>CEWELD</b> <b>E Guts</b>				<b>E Guts</b> is suitable for gouging and cutting of all electrically conductive materials, it is used on aluminum, cast iron, steel, copper, nickel etc. It can be a solution in cases where a cutting flame will produce too much heat or at hardly reachable places. <b>It can also be very useful on materials that cannot be flame cut such as stainless steel.</b>
--------------------------------	--	--	--	--

## 25. FOR UNDER WATER (WET) WELDING

<b>CEWELD</b> <b>AquaForce</b> <b>HR</b>	<b>9606-1: FM1</b> <b>Sect IX QW-432 : F-No. 1</b> <b>DIN 2302:</b> E 42 0 R 10 fr (PA,PB,PC,PD,PE,PG) <b>A 5.1:</b> E 7014 <b>A 5.35:</b> UWE 7014 3A	T 500-640 MPa Y > 420 MPa E > 22% I > 35J (0 °C) I > 27J (-20 °C)	C < 0,075 Mn ~ 0,75 Si ~ 0,6 P < 0,25 S < 0,25	<b>AquaForce HR</b> is a <b>high recovery underwater electrode</b> that is double coated to provide maximum resistance to moisture. <b>AquaForce HR</b> is capable of producing <b>beautiful flat filled welds</b> with deep penetration without porosity. Filled welds exceeding <b>ana- height of 4,0 mm are easy to achieve</b> in one single layer for high productivity. <b>AquaForce HR</b> can used in all positions, especially suitable for vertical down (PG) position. All applications underwater for carbon steels up to <b>420 MPa to -0 °C</b> (-20 °C). Tested up to a water depth of 20m.
<b>CEWELD</b> <b>AquaForce</b> <b>LC</b>	<b>9606-1: FM1</b> <b>Sect IX QW-432 : F-No. 1</b> <b>DIN 2302:</b> E 42 2 Z RB 10 fr (PA,PB,PC,PD,PE,PG) <b>A 5.1:</b> E 7016 <b>A 5.35:</b> UWE 7016 3A	T 500-640 MPa Y > 420 MPa E > 22% I > 47J (0 °C) I > 35J (-20 °C)	C < 0,05 Mn ~ 0,45 Si ~ 0,2 P < 0,25 S < 0,25	<b>AquaForce LC</b> is the first <b>basic electrode</b> that was developed with " <b>Hydrophobic sand</b> " to offer maximum moisture resistance. <b>AquaForce LC</b> is characterized by its superior ability to produce flat (non-concave) welds with deeper penetration in all positions including PB, PC, PD, PE and PG position. The special (Armcore) <b>ultra low carbon core wire</b> of this electrode reduces the hardness from <b>195 HV to 165 HV hardness</b> in the pure weldmetal caused by the high cooling rate (T8/5) when welding under water. All applications underwater for carbon steels up to <b>420 MPa to -20 °C</b> . Tested up to a water depth of 20m.
<b>CEWELD</b> <b>AquaForce</b> <b>MG</b>	<b>9606-1: FM1</b> <b>Sect IX QW-432: F-No. 1</b> <b>DIN 2302:</b> E 42 0 Z RR 10 fr (PA,PB,PC,PD,PE,PG) <b>A 5.1:</b> E 6013 <b>A 5.35:</b> UWE 6013 3A	T 490-640 MPa Y > 400 MPa E > 22% I > 35J (0 °C) I > 27J (-20 °C)	C < 0,08 Mn ~ 0,7 Si ~ 0,4 P < 0,25 S < 0,25	<b>AquaForce MG</b> is a <b>high recovery underwater electrode</b> and provide maximum resistance to moisture. <b>AquaForce MG</b> is producing <b>beautiful flat filled welds</b> with deep penetration without porosity. Filled welds exceeding <b>ana- height of 3-4 mm are easy to achieve</b> in one single layer for high productivity. <b>AquaForce MG</b> especially suitable for vertical down (PG) position. All applications underwater for carbon steels up to <b>400 MPa to -0 °C</b> (-20 °C). Tested up to a water depth of 20m.





# 2 - CORED WIRES

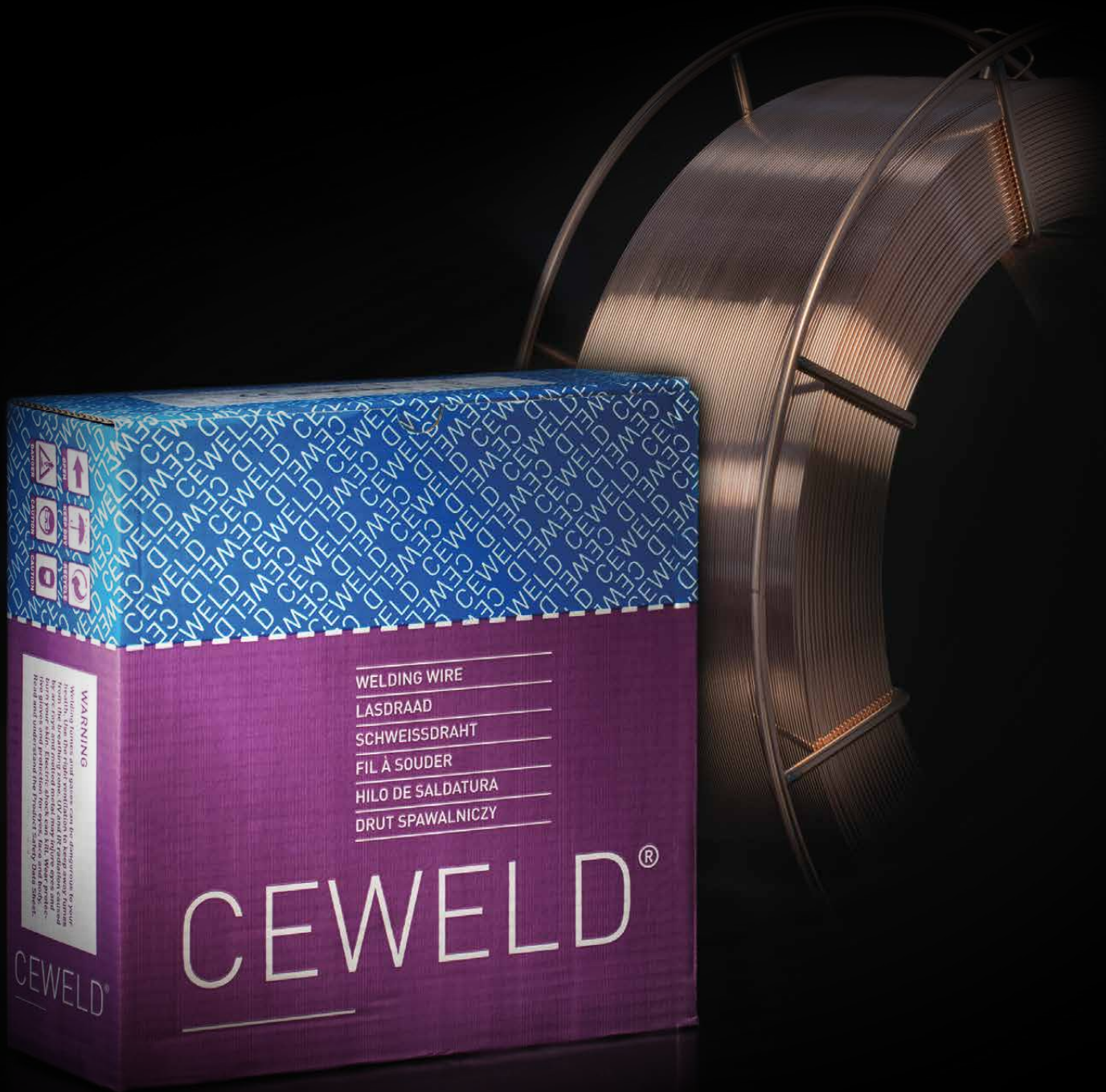

# CORED WIRE

No.	Group	Page
0	OVERVIEW OF THE PRODUCTS	2/3-5

## CORED WIRE FOR JOINT WELDING

1	METAL CORED WIRE FOR NON - ALLOY AND FINE GRAIN STEEL	2/6
2	METAL CORED WIRE FOR CREEP RESISTANT STEEL	2/7
3	METAL CORED FOR WEATHER RESISTANT STEEL	2/7
4	RUTILE FLUX WIRE FOR NON-ALLOY AND FINE GRAIN STEEL	2/7-8
5	RUTILE FLUX WIRE FOR CREEP RESISTANT STEEL	2/8
6	RUTILE FLUX WIRE FOR WEATHER RESISTANT STEEL	2/8
7	BASIC FLUX CORED WIRE FOR LOW - ALLOY AND FINE GRAIN STEEL	2/8-9
8	BASIC FLUX CORED WIRE FOR CREEP RESISTANT STEEL	2/9
9	BASIC FLUX CORED WIRE FOR WEATHER RESISTANT STEEL	2/10
10	SELF SHIELDING WIRE FOR LOW - ALLOY AND FINE GRAIN STEEL	2/10

## CORED WIRE FOR JOINT WELDING HIGH ALLOY STEEL

11	FOR STAINLESS STEEL	2/11-13
12	FOR STAINLESS DUPLEX STEEL	2/13
13	FOR NICKEL BASED ALLOYS	2/14
14	FOR STELLITE ALLOY ( COBALT BASED )	2/15
15	FOR CAST IRON	2/15

## CORED WIRE FOR HARDFACING

16	FOR SHOCK AND ABRASION AFTER STRAIN HARDENING ( AUSTENITIC)	2/15
17	FOR SHOCK AND ABRASION	2/15-16
18	FOR HIGH ABRASION	2/16
19	FOR EXTREME WEAR RESISTANT	2/17-18
20	FOR HARDFACING TUNGSTEN AND COBALT BASE	2/18
21	FOR HARDFACING WITH STAINLESS ALLOY	2/19

CLICK HERE FOR EXTENDED SEARCH

SEARCH

**Disclaimer:** Whilst all reasonable efforts have been made to ensure the accuracy of the information contained, the information contained or otherwise referenced herein is presented only as "typical" without guarantee or warranty, and any liability incurred from any reliance thereon is expressly disclaimed. Typical data are those obtained when welded and tested in accordance to prescribed standards, and should not be assumed to be the expected results in a particular application or weldment. Other tests and procedures may produce different results. Users are cautioned to confirm by qualification testing, or other appropriate means, the suitability of any welding consumable and procedure before use in the intended application. The selection and use of specific products is solely within the control of, and remains the sole responsibility of the customer. The right to change design and/or specifications without notice is reserved.

**Certilas Nederland B.V. | Gloxinialaan 2, 6851 TG Huissen, The Netherlands | info@certilas.com | www.certilas.com | Rev.2023.**

Overview - **CORED WIRE**

No.	Product Name	ISO	ASME	FM Group	F-Number:	Page
<b>1. METAL CORED WIRE FOR NON-ALLOYED AND FINE GRAIN STEEL</b>						
1	CEWELD AA M400	17632-A: T 42 4 M M21 1 H5	A 5.18: E70C-6M H4 A 5.36: E71T15-M21A8-CS1-H4	FM1	F-No. 6	2/6
2	CEWELD AA M460	17632-A: T 46 6 M M21 1 H5	A 5.18: E70C-6M H4 A 5.36: E81T15-M21A8-CS1-H4	FM1	F-No. 6	2/6
3	CEWELD AA M500	17632-A: T 50 6 Ni1 M M21 1 H5	A 5.28: E80C-Ni1M H4 A 5.36: E81T15-M21A8-Ni1-H4	FM1	F-No. 6	2/6
4	CEWELD AA M550	18276-A: T 55 6 Mn2,5Ni M M21 1 H5	A 5.36: E91T15-M21A8-K7-H4	FM1	F-No. 6	2/6
5	CEWELD AA M550 SR	18276-A: T 55 6 1NiMo M M 1 H5	A 5.28: E90C-K3M H4 A 5.36: E91T15-M21P4-K1-H4	FM2	F-No. 6	2/6
6	CEWELD AA M690	18276-A: T 69 6 Mn2NiCrMo M M21 1 H5	A 5.28: E110C-K4M H4 A 5.36: E111T15-M21A8-K4-H4	FM2	F-No. 6	2/6
7	CEWELD AA M960	18276-A: T 89 4 Mn2NiCrMo M M21 1 H5	A 5.28: ~E120C-K4 H4 A 5.36: E131T15-M21A4-K4-H4	FM2	F-No. 6	2/6
<b>2. METAL CORED WIRE FOR CREEP RESISTANT STEEL</b>						
8	CEWELD AA MMo	17634-A: T Mo M M21 1 H5	A 5.28: E80C-G H4 A 5.36: E81T15-M21P4-A1-H4	FM3	F-No. 6	2/7
9	CEWELD AA M CrMo1	17634-A: T CrMo1 M M21 1 H5	A 5.28: E 80C-B2 H4 A 5.36: E81T15-M21P4-B2-H4	FM3	F-No. 6	2/7
<b>3. METAL CORED WIRE FOR WEATHER RESISTANT STEEL</b>						
10	CEWELD AA M Corten	17632-A: T 46 4 Z M M21 1 H5	A 5.28: E80 C-W2-H4 A 5.36: E81T15-M21A4-W2-H4	FM1	F-No. 6	2/7
<b>4. RUTILE FLUXCORED WIRE FOR NON-ALLOYED AND FINE GRAIN STEEL</b>						
11	CEWELD AA R400	17632-A: T 42 4 P M21 1 H5	A 5.20: E71T-1M -J H4 A 5.36: E71T1-M21 A4-CS1-H4	FM1	F-No. 6	2/7
12	CEWELD AA R460	17632-A: T 46 4 P M21 1 H5 17632-A: T 42 2 P C1 1 H5	A 5.20: E71T-1M /1C-J H4 A 5.36: E71T1-M21 A4-CS1-H4 A 5.36: E71T-1CA0-CS1-H4	FM1	F-No. 6	2/7
13	CEWELD AA R460 LT	17632-A: T 46 6 P M21 1 H5 17632-A: T 46 4 P C1 1 H5	A 5.20: E71T-1M /1C-J H4 A 5.36: E71T1-M21 A4-CS1-H4 A 5.36: E71T-1CA4-CS1-H4	FM1	F-No. 6	2/7
14	CEWELD AA R500	17632-A: T 50 6 1Ni P M21 1 H5 17632-A: T 46 4 1Ni P C1 1 H5	A 5.29: E81T1-Ni1M-J H4 A 5.36: E81T1-M21A8-Ni1-H4 A 5.36: E81T1-C1A4-Ni1-H4	FM1	F-No. 6	2/7
15	CEWELD AA R500 SR	17632-A: T 50 6 1Ni P M21 1 H5	A 5.29: E81T1-Ni1M-J H4 A 5.36: E81T1-M21A8-Ni1-H4	FM1	F-No. 6	2/8
16	CEWELD AA R500 PIPE	17632-A: T 50 4 Mn1Ni P M21 1 H5	A 5.36: E81T1-M21A4-Ni1-H4	FM1	F-No. 6	2/8
17	CEWELD AA R690	18276-A: T 69 6 Z P M21 1 H5	A 5.29: E111C-K4 H4 A 5.36: E111T1-M21A4-G-H4	FM2	F-No. 6	2/8
<b>5. RUTILE FLUX CORED WIRE FOR CREEP RESISTANT STEEL</b>						
18	CEWELD AA R Mo	17634-A: T MoL P M21 1 H5	A 5.29: E81T1-A1M H4 A 5.36: E81T1-M21PY-A1-H4	FM3	F-No. 6	2/8
19	CEWELD AA R CrMo1	17634-A: T CrMo1 P M21 1 H5	A 5.29: E81T1-B2M H4 A 5.36: E81T1-M21PY-B2-H4	FM3	F-No. 6	2/8
<b>6. RUTILE FLUX CORED WIRE FOR WEATHER RESISTANT STEEL</b>						
20	CEWELD AA R Corten	17632-A: T 46 2 Z P M21 H5	A 5.29: E81T1-G H4 A 5.36: E81T1-M21 A4-G-H4	FM1	F-No. 6	2/8
<b>7. BASIC FLUX CORED WIRE FOR NON ALLOYED AND FINE GRAIN STEEL</b>						
21	CEWELD AA B460	17632-A: T 46 6 B M21 3 H5 17632-A: T 42 4 B C1 3 H5	A 5.20: E70T5-M / C-J H4 A 5.36: E71T5-M21 A8-CS1-H4 A 5.36: E71T5-1C-A4-CS1-H4	FM1	F-No. 6	2/8
22	CEWELD AA B500	17632-A: T 50 6 1Ni B M21 1 H5	A 5.29: E80T5-Ni1-J H4 A 5.36: E80T5-M21A8-Ni1-H4	FM1	F-No. 6	2/8
23	CEWELD AA B550	18276-A: T 55 6 1NiMo B M21 1 H5	A 5.29: E80T5-Ni1M-J H4 A 5.36: E80T5-M21A4-Ni1-H4	FM2	F-No. 6	2/9
24	CEWELD AA B690	18276-A: T 69 6 Mn2NiCrMo B M21 3 H5	A 5.29: E110T5-K4M H4 A 5.36: E110T5-M21A8-K4-H4	FM2	F-No. 6	2/9
25	CEWELD AA B960	18276 A: T 89 4 Mn 2Ni1CrMo B M21 3 H5	A 5.36: E130T5-M21A4-K4-H4	FM2	F-No. 6	2/9

# CORED WIRE - Overview

No.	Product Name	ISO	ASME	FM Group	F-Number:	Page
<b>8. BASIC FLUX CORED WIRE FOR CREEP RESISTANT STEEL</b>						
27	CEWELD AA B Mo	17634-A: T Mo B M21 3 H5	A 5.29: E80T5-G H4 A 5.36: E80T5-M21P4-A1-H4	FM 4	F-No. 6	2/9
28	CEWELD AA B CrMo1	17634-A: T CrMo1 B M21 3 H5	A 5.29: E80T5-B2M H4 A 5.36: E80T5-M21PY-B2-H4	FM 4	F-No. 6	2/9
29	CEWELD AA B CrMo2	17634-A: T CrMo2 B M21 3 H5	A 5.29: E90T5-B3M H4 A 5.36: E90T5-M21PY-B3-H4	FM 4	F-No. 6	2/9
30	CEWELD AA B CrMo1V	17634-A: T CrMo1 B M21 3 H5	A 5.29: E80T5-B2M H4 A 5.36: E80T5-M21PY-B2-H4	FM 4	F-No. 6	2/9
<b>9. BASIC FLUX CORED WIRE FOR WEATHER RESISTANT STEEL</b>						
31	CEWELD AA B Corten	17632-A: T 46 2 Z B M21 3 H5	A 5.29: E85T5-G H4 A 5.36: E80T5-M21 A4-G-H4	FM 1	F-No. 6	2/10
<b>10. SELF SHIELDING CORED WIRE FOR NON-ALLOYED AND FINE GRAIN STEEL</b>						
32	CEWELD OA S-71-TGS	17632-A: T 42 Z W N 1 H15	A 5.20: E71T-GS	FM 1	F-No. 6	2/10
33	CEWELD OA S-71-T8	17632-A: T 42 2 Y N 2 H10	A 5.20: E71 T-8JD H8	FM 1	F-No. 6	2/10
34	CEWELD OA S-70-T4R	17632-A: T 38 Z W N 3 H15	A 5.20: E70 T-4	FM 1	F-No. 6	2/10
<b>11. CORED WIRE FOR STAINLESS STEEL</b>						
35	CEWELD AA M 410 NiMo	17633-A: T 13 4 / T 410 NiMo	A 5.22: E410NiMoT0-4	FM 5	F-No. 6	2/11
36	CEWELD AA 307	17633-A: T 18 8 Mn R M21 3	A 5.22: ~E307T0-4	FM 5	F-No. 6	2/11
37	CEWELD AA 307P	17633-A: T 18 8 Mn P M21/C1 1	A 5.22: ~E307T1-4 A 5.22: ~E307T1-1	FM 5	F-No. 6	2/11
38	CEWELD AA 308 L	17633-A: T 19 9 L R M21/C1 3	A 5.22: E308LT0-4 A 5.22: E308LT0-1	FM 5	F-No. 6	2/11
39	CEWELD AA 308LP	17633-A: T 19 9 L P M21 1	A 5.22: E308LT1-4 A 5.22: E308LT1-1	FM 5	F-No. 6	2/11
40	CEWELD AA 308H	17633-A: T 19 9 H R M21 3	A 5.22: E308HT0-4 A 5.22: E308HT0-1	FM 5	F-No. 6	2/11
41	CEWELD AA 309L	17633-A: T 23 12 L R M21 3	A 5.22: E309LT0-1 A 5.22: E309LT0-4	FM 5	F-No. 6	2/11
42	CEWELD AA 309LP	17633-A: T 23 12 L P M21 1	A 5.22: E309LT1-1 A 5.22: E309LT1-4	FM 5	F-No. 6	2/11
43	CEWELD AA 309LNb	17633-A: TZ 23 12 L Nb R M21 1	A 5.22: E309LNbT1-1 A 5.22: E309LNbT1-4	FM 5	F-No. 6	2/11
44	CEWELD AA 309LMo	17633-A: T 23 12 2 L R C1/M21 3	A 5.22: E309LMoT0-1 A 5.22: E309LMoT0-4	FM 5	F-No. 6	2/12
45	CEWELD AA 309LMoP	17633-A: T 23 12 2 L R C1/M21 1	A 5.22: E309LMoT1-1 A 5.22: E309LMoT1-4	FM 5	F-No. 6	2/12
46	CEWELD AA 310	17633-A: T 25 20 R C1/M21 3	A 5.22: E310T0-1 A 5.22: E310T0-4	FM 5	F-No. 6	2/12
47	CEWELD AA 312	17633-A: T 29 9 R M21 3	A 5.22: E312T0-4	FM 5	F-No. 6	2/12
48	CEWELD AA 316L	17633-A: T 19 12 3 L R M21 3 (1)	A 5.22: E316LT0-1 A 5.22: E316LT0-4	FM 5	F-No. 6	2/12
49	CEWELD AA 316LP	17633-A: T 19 12 3 L P M21 1	A 5.22: E316LT1-1 A 5.22: E316LT1-4	FM 5	F-No. 6	2/12
50	CEWELD AA 317L	17633-A: TZ 19 13 4 L R M21/C1 3	A 5.22: E317LT0-1 A 5.22: E317LT0-4	FM 5	F-No. 6	2/12
51	CEWELD AA 318	17633-A: T 19 12 3 Nb P M21 1	-	FM 5	F-No. 6	2/12
52	CEWELD AA 347H	17633-A: T 19 9 Nb P C1/M21 2	A 5.22: E347T1-1 A 5.22: E347T1-4	FM 5	F-No. 6	2/13
<b>12. CORED WIRE FOR STAINLESS STEEL (DUPLEX STEEL)</b>						
53	CEWELD AA 2101 (Lean Duplex)	17633-A: T 23 7 N L P C1/M21 2	A 5.22: E 2307 T1-1 A 5.22: E 2307 T1-4	FM 5	F-No. 6	2/13
54	CEWELD AA 2209	17633-A: T 22 9 3 N L R M21 3	A 5.22: E 2209 T0-4	FM 5	F-No. 6	2/13
55	CEWELD AA 2209P	17633-A: T 22 9 3 N L P M21 1	A 5.22: E 2209 T1-4	FM 5	F-No. 6	2/13
56	CEWELD AA 2209Pi	17633-A: T 22 9 3 N L R M21 1	A 5.22: E 2209 T1-4	FM 5	F-No. 6	2/13
57	CEWELD AA 2594	17633-A: T 25 9 4 N L P C1/M21 1	A 5.22: E 2594 T1-1 A 5.22: E 2594 T1-4	FM 5	F-No. 6	2/13
58	CEWELD AA 2594M	17633-A: T 25 9 4 Cu N L M M12 1	A 5.22: EC 2594	FM 5	F-No. 6	2/13
59	CEWELD AA 904L	17633-A: T 20 25 5 Cu N L P M21 2	A 5.22: ~ E 385L T0-4	FM 5	F-No. 6	2/13

Overview - **CORED WIRE**

No.	Product Name	ISO	ASME	FM Group	F-Number:	Page
<b>13. CORED WIRE FOR NICKEL BASED ALLOYS</b>						
60	CEWELD AA C-276	12153-A: TNi 6276 P M21 2 (NiCr15Mo15Fe6W4)	A 5.34: ENiCrMo4T0-4	FM 5	F-No. 43	2/14
61	CEWELD AA NiCro 600	12153-A: TNi 6182 R M21 3 (NiCr15Fe6Mn)	A 5.34: ENiCr3T0-4	FM 5	F-No. 43	2/14
62	CEWELD AA NiCro 600B	12153-A: TNi 6182 B M21 3 (NiCr15Fe6Mn)	A 5.34: ENiCr3T0-4	FM 5	F-No. 43	2/14
63	CEWELD AA NiCro 625	12153-A: TNi 6625 P M21 2 (NiCr22Mo9Nb)	A 5.34: ENiCrMo3T0-4	FM 5	F-No. 43	2/14
64	CEWELD AA NiCro 625B	12153-A: TNi 6625 B M21 3 (NiCr22Mo9Nb)	A 5.34: ENiCrMo3T0-4	FM 5	F-No. 43	2/14
<b>14. CORED WIRE ON STELLITE BASED (COBALT BASED ALLOYS)</b>						
65	CEWELD AA DUR 1	14700: T Co2-55-CGTZ (DIN 8555 MSG 20-GF-55-CTZ )	A 5.21: ERCCoCr-C UNS W73031	-	F-No. 71	2/15
66	CEWELD AA DUR 6	14700: T Co2-45-CTZ (DIN 8555 MSG 20-GF-45-CTZ)	A 5.21: ERCCoCr-A UNS W73036	-	F-No. 71	2/15
67	CEWELD AA DUR 12	14700: T Co2-50-CTZ (DIN 8555 MSG 20-GF-50-CTZ )	A 5.21: ERCCoCr-B UNS W73042	-	F-No. 71	2/15
68	CEWELD AA DUR 21	14700: T Co1-350-CKTZ (DIN 8555 MSG 20-GF-350-CTZ )	A 5.21: ERCCoCr-E UNS W73041	-	F-No. 71	2/15
<b>15. CORED WIRE FOR CAST IRON</b>						
69	CEWELD AA FENI	1071: T C Z NiFe-1 M (~DIN 8555 MF NiFe-2)	-	-	-	2/15
<b>16. FOR HARDFACING, SHOCK AND ABRASION RESISTANT AFTER STRAIN HARDENING (AUSTENITIC)</b>						
70	CEWELD OA MnCr	14700: T Fe 9 (DIN 8555 MF 7-250-KNP )	-	-	-	2/15
71	CEWELD OA Mn14	14700: T Fe 9 (DIN 8555 MF 7-200-KNP )	-	-	-	2/15
<b>17. FOR HARDFACING, SHOCK AND ABRASION RESISTANT</b>						
72	CEWELD OA 350	14700: T Fe 3 (DIN 8555 MF 1-350-ST)	-	-	-	2/15
73	CEWELD OA 400	14700: TZ Fe 1 (DIN 8555 MF 3-400-ST )	-	-	-	2/15
74	CEWELD AA M37-42	14700: T Fe 2 (DIN 8555 MF 1 - GF - 40 GPS)	-	-	-	2/16
75	CEWELD OA 550-VW	14700: T Fe 6 (DIN 8555 MF 6-60-PT )	-	-	-	2/16
76	CEWELD AA M57-62	14700: T Fe 2 (DIN 8555 MSG 6 - GF - 60 P)	-	-	-	2/16
<b>18. FOR HARDFACING, HIGH ABRASION RESISTANT</b>						
77	CEWELD OA 54 L	14700: TZ Fe14 (DIN 8555 MF 10-55-CGT )	-	-	-	2/16
78	CEWELD OA 55 TC	14700: T Fe8 (DIN 8555 MF 6-60-GP )	-	-	-	2/16
79	CEWELD OA 56 NB	14700: T Fe8 (DIN 8555 MF 6-55-GP )	-	-	-	2/16
<b>19. FOR HARDFACING, EXTREME WEAR RESISTANT</b>						
80	CEWELD OA 612	14700: T Fe8 (DIN 8555 MF 6-GF-55-RP )	-	-	-	2/17
81	CEWELD OA 57-62 Nb	14700: T Fe8 (DIN 8555 MF 6-GF-60-GP )	-	-	-	2/17
82	CEWELD OA 58	14700: T Fe15 (DIN 8555 MF 10-60-G )	-	-	-	2/17
83	CEWELD OA 59	14700: T Fe15 (DIN 8555 MF 10-GF-60-G )	-	-	-	2/17
84	CEWELD OA 59 H	14700: T Fe15 (DIN 8555 MF 10-GF-65-G )	-	-	-	2/17
85	CEWELD OA 60-68 B	14700: T Fe13 (DIN 8555 MF 4-GF-65-G )	-	-	-	2/17
86	CEWELD OA 60-70 B	14700: T Z Fe13 (DIN 8555 MF 10-GF-70-G )	-	-	-	2/17
87	CEWELD MA 600 (1.4718)	14700: T Fe 8 (DIN 8555 MF 6-GF-60-G )	-	-	-	2/17
88	CEWELD OA 61	14700: T Fe16 (DIN 8555 MF 10-GF-65-G )	-	-	-	2/17
89	CEWELD OA 62	14700: T Fe15 (DIN 8555 MF 10-70-GRZ )	-	-	-	2/17
90	CEWELD OA 63	14700: T Fe15 (DIN 8555 MF 10-65-G )	-	-	-	2/18
91	CEWELD OA 63 V	14700: T Fe16 (DIN 8555 MF 10-65-GZ )	-	-	-	2/18
92	CEWELD OA 63 VWB	14700: ZT Fe15 (DIN 8555 MF 10-GF-65-G)	-	-	-	2/18
93	CEWELD OA 64	14700: T Fe16 (DIN 8555 MF 10-65-GZ )	-	-	-	2/18
94	CEWELD OA 67 NiB	14700: T Fe13 (DIN 8555 MF 2-GF-70-G )	-	-	-	2/18
95	CEWELD OA 68 NB	14700: T Fe 16 (DIN 8555 MF 10-70-G )	-	-	-	2/18
<b>20. FOR HARDFACING, TUNGSTEN BASED ALLOYS</b>						
96	CEWELD OA WC2 Ni	14700: T Ni 20 (DIN 8555 MF 21-GF-55-CGTZ )	-	-	-	2/18
97	CEWELD OA WC2 Fe	14700: T Fe 20 (DIN 8555 MF 21-GF-65-GZ )	-	-	-	2/18
<b>21. FOR HARDFACING WITH STAINLESS ALLOY</b>						
98	CEWELD AA 410	14700: T Fe7	A 5.22: E 410T0-4	-	-	2/19
99	CEWELD AA 410 NiMo	14700: T Fe7	A 5.22: E 410 NiMoT0-4	-	-	2/19
100	CEWELD OA 410 NiMo	14700: T Fe7	A 5.22: E 410 NiMoT0-3	-	-	2/19



## CORED WIRE

TYPE	EN -ISO and ASME -AWS	MECHANICAL PROPERTIES	ANALYSIS	APPLICATION
<b>1. METAL CORED WIRE FOR NON-ALLOYED AND FINE GRAIN STEEL</b>				
<b>CEWELD AA M400</b>	<b>9606-1: FM1</b> <b>Sect IX QW-432: F-No. 6</b> <b>17632-A:</b> T 42 4 M M21 1 H5 <b>A 5.18:</b> E 70C-6M H4 <b>A 5.36:</b> E71T15-M21A8-CS1-H4	T 500-640 MPa Y > 420 MPa E > 24% I ~ 70J (-40 °C)	C < 0,08 Mn ~ 1,3 Si ~ 0,5 P < 0,015 S < 0,015	<b>AA M400 is a seamless metal cored wire</b> for high productivity welding, offering excellent properties for both short- and spray arc range. Excellent arc re-start even with cold wire tip, particularly well-suited for robotic applications with high deposition efficiency. <b>Excellent gap bridging during root welding.</b> Wide range of voltage setting from 14 to 32 Volts. Excellent Impact values. <b>CTOD tested to -20 °C.</b> Low hydrogen content <b>HD&lt;3 ml/100g</b> even after long storage.
<b>CEWELD AA M460</b>	<b>9606-1: FM1</b> <b>Sect IX QW-432: F-No. 6</b> <b>17632-A:</b> T 46 6 M M21 1 H5 <b>A 5.18:</b> E 70C-6M H4 <b>A 5.36:</b> E81T15-M21A8-CS1-H4	T 550-680 MPa Y > 460 MPa E > 24% I ~ 70J (-60 °C)	C < 0,05 Mn ~ 1,5 Si ~ 0,7 P < 0,015 S < 0,015	<b>AA M460 is a seamless metal cored wire</b> with remarkable stable arc and no spatters. <b>Excellent for use in automated welding applications</b> such as orbital Mag or <b>robotic welding.</b> This wire offers a unique approval class at most third parties that enables you to use only one wire to cover more procedures up to <b>460MPa</b> yield strength steels. <b>AA M460</b> can also be used for constructions that needs <b>post weld heat treatment</b> after welding and still offers mechanical properties confirming <b>5Y46 class.</b> Low hydrogen content <b>HD&lt;3 ml/100g</b> even after long storage. <b>CTOD tested at -20 °C.</b>
<b>CEWELD AA M500</b>	<b>9606-1: FM1</b> <b>Sect IX QW-432: F-No. 6</b> <b>17632-A:</b> T 50 6 Ni1 M M21 1 H5 <b>A 5.28:</b> E80C-Ni1 H4 <b>A 5.36:</b> E81T15-M21A8-Ni1-H4	T 550-720 MPa Y > 500 MPa E > 24% I ~ 70J (-60 °C)	C < 0,05 Mn ~ 1,5 Si ~ 0,7 P < 0,015 S < 0,015 Ni ~ 0,9	<b>AA M500 is a seamless metal cored wire</b> with remarkable stable arc and no spatters. Excellent for use in automated welding applications such as orbital MAG or robotic welding. This wire offers a unique welding deposit with <b>less than 1% nickel to fulfill NACE</b> requirements and cover more procedures up to 500 MPa yield strength steels. <b>AA M500</b> can also be used for constructions that needs post weld heat treatment after welding and still offers mechanical properties confirming <b>5Y46 class.</b> Low hydrogen content <b>HD&lt;3 ml/100g</b> even after long storage.
<b>CEWELD AA M550</b>	<b>9606-1: FM2</b> <b>Sect IX QW-432: F-No. 6</b> <b>18276-A:</b> T 55 6 Mn2,5Ni M M21 1 H5 <b>A 5.36:</b> E91T15-M21A8-K7-H4	T 640-820 MPa Y > 550 MPa E > 24% I ~ 70J (-60 °C)	C < 0,05 Mn ~ 1,5 Si ~ 0,7 P < 0,015 S < 0,015 Ni ~ 2,2	<b>AA M550 is a seamless metal cored wire</b> with remarkable stable arc and no spatters. Excellent for use in automated welding applications such as orbital MAG or robotic welding. This wire offers a unique welding deposit with <b>more than 2% nickel</b> to offer reliable impact properties down to <b>-60°C.</b> Ceweld <b>AA M550</b> is used for welding <b>550 MPa</b> yield strength steels. Low hydrogen content <b>HD&lt;3 ml/100g</b> even after long unconditioned storage.
<b>CEWELD AA M550 SR</b>	<b>9606-1: FM2</b> <b>Sect IX QW-432: F-No. 6</b> <b>18276-A:</b> T 55 6 1NiMo M M 1 H5 <b>A 5.28:</b> E90C-K3M H4 <b>A 5.36:</b> E90C-K3M H4	T 640-820 MPa Y > 550 MPa E ~ 20% I ~ 60J (-60 °C) <b>after PWHT</b> T 620-720 MPa Y > 540 MPa E > 20% I ~ 50J (-60 °C)	C < 0,05 Mn ~ 1,3 Si ~ 0,5 P < 0,015 S < 0,015 Ni ~ 0,9 Mo < 0,45	<b>AA M550SR is a seamless metal cored wire</b> with remarkable stable arc and no spatters. Excellent for use in automated welding applications such as orbital MAG or robotic welding. This wire offers a unique welding deposit with <b>less than 1% nickel</b> to offer reliable impact properties down to <b>-60°C.</b> AA M550 SR is used for welding <b>550 MPa</b> yield strength steels also after <b>PWHT.</b> Low hydrogen content <b>&lt;3 ml/100g</b> even after long storage.
<b>CEWELD AA M690</b>	<b>9606-1: FM2</b> <b>Sect IX QW-432: F-No. 6</b> <b>18276-A:</b> T 69 6 Mn2NiCrMo M M21 1 H5 <b>A 5.28:</b> E 110 C-K4M H4 <b>A 5.36:</b> E111T15-M21A8-K4-H4	T 770-940 MPa Y > 690 MPa E > 18% I ~ 80J (-60 °C)	C < 0,05 Mn ~ 1,6 Si ~ 0,4 P < 0,015 S < 0,015 Cr ~ 0,5 Ni ~ 2,2 Mo ~ 0,5	<b>AA M690 is a seamless metal cored wire</b> with remarkable <b>crack resistant</b> weld metal with very low hydrogen content <b>HD&lt;3 ml/100g</b> Therefore, suitable for the economic processing of <b>high-strength and low temperature fine grained structural steels.</b> Excellent welding properties for both short- and spray arc. High deposition rate and no intermediate cleaning required with very low spatter loss. Excellent wetting properties compare to solid wires that results in a bigger parameter range and improved duty cycle for the welder.
<b>CEWELD AA M960</b>	<b>9606-1: FM2</b> <b>Sect IX QW-432 : F-No. 6</b> <b>18276-A:</b> T 89 4 Mn2NiCrMo M M21 1 H5 <b>A 5.28:</b> ~E 120 C-K4 H4 <b>A 5.36</b> E131T15-M21A4-K4-H4	T 940-1040 MPa Y ~ 960 MPa E > 17% I ~ 55J (-40 °C)	C < 0,05 Mn ~ 1,6 Si ~ 0,4 P < 0,01 S < 0,01 Cr ~ 0,5 Ni ~ 2,6 Mo ~ 0,6	<b>AA M960 is a seamless metal cored wire</b> that offers excellent re-starting properties even with cold wire tip. <b>Suitable for robot applications.</b> Applicable for both short- as spray arc. Excellent gap bridging for root welding. High-efficiency type for economic production of <b>high-strength fine-grain structural steels up to 1100 MPa Yield Strength.</b> Stable mechanical properties up to <b>heat input of 10 kJ/cm.</b> Low hydrogen content <b>HD&lt;3 ml/100g</b> even after long storage.



TYPE	EN -ISO and ASME -AWS	MECHANICAL PROPERTIES	ANALYSIS	APPLICATION
------	-----------------------	-----------------------	----------	-------------

## 2. METAL CORED WIRE FOR CREEP RESISTANT STEEL

<b>CEWELD AA MMo</b>	<b>9606-1:</b> FM3 <b>Sect IX QW-432 :</b> F-No. 6 <b>17634-A:</b> T Mo M M21 1 H5 <b>A 5.28:</b> E80C-G H4 <b>A 5.36:</b> E81T15-M21P4-A1-H4	T 550-690 MPa Y > 470 MPa E > 24% I ~ 50J (-40 °C)	C < 0,05 Mn ~ 1,3 Si ~ 0,7 P < 0,015 S < 0,015 Mo ~ 0,5	<b>AA MMo</b> is a <b>seamless metal cored</b> wire that offers excellent re-starting properties even with cold wire tip. Suitable for robot applications. Applicable for both short- and spray arc. Excellent gap bridging properties for root welding. High-efficiency type for economic production on <b>Heat resistant Mo-steels up to 500 °C</b> . Low hydrogen content <b>HD&lt;3 ml/100g</b> even after long storage. <b>Typical: 15Mo3, 16Mo3, A 204 Gr. A - C, ASTM A106 gr. A-B-C.</b>
<b>CEWELD AA M CrMo1</b>	<b>9606-1:</b> FM3 <b>Sect IX QW-432 :</b> F-No. 6 <b>17634-A:</b> T CrMo1 M M21 1 H5 <b>A 5.28:</b> E 80C-B2 H4 <b>A 5.36:</b> E81T15-M21P4-B2-H4	T 550-740 MPa Y > 470 MPa E > 20% I ~ 50J (-40 °C)	C < 0,05 Mn ~ 1,4 Si ~ 0,3 P < 0,015 S < 0,015 Cr ~ 1,1 Mo ~ 0,5	<b>AA MCrMo1</b> is a <b>seamless metal cored</b> wire that offers excellent re-starting properties even with cold wire tip. Suitable for robot applications. Applicable for both short- and spray arc. Excellent gap bridging properties for root welding. High-efficiency type for economic production of <b>CrMo-steels up to 550 °C</b> . Low hydrogen content <b>HD&lt;3 ml/100g</b> even after long unconditioned storage. <b>Typical: 13CrMo44, 13CrMo4-5, A 387 Gr. 11-12, 24CrMo5, GS 17CrMo55, GS 22CrMo54,G 17CrMo5-5, G22CrMo5-4</b>

## 3. METAL CORED WIRE FOR WEATHER RESISTANT STEEL

<b>CEWELD AA M Corten</b>	<b>9606-1:</b> FM1 <b>Sect IX QW-432 :</b> F-No. 6 <b>17632-A:</b> T 46 4 Z M M21 1 H5 <b>A 5.28:</b> E80 C-W2-H4 <b>A 5.36:</b> E81T15-M21A4-W2-H4	T 550-680 MPa Y > 470 MPa E > 22% I ~ 70J (-40 °C)	C ~ 0,05 Mn ~ 1,2 Si ~ 0,7 P < 0,01 S < 0,01 Cr ~ 0,5 Ni ~ 0,7 Cu ~ 0,5	<b>AA M Corten</b> is a <b>seamless metal cored</b> wire with remarkable stable arc and no spatters. Excellent for use in automated welding applications such as orbital MAG or robotic welding. This wire offers a unique welding deposit with <b>± 0,7% Ni and 0,5% Cu</b> . Low hydrogen content <b>HD&lt;3 ml/100g</b> even after long unconditioned storage.
-------------------------------	--	---	--	---

## 4. RUTILE FLUXCORED WIRE FOR NON-ALLOYED AND FINE GRAIN STEEL

<b>CEWELD AA R400</b>	<b>9606-1:</b> FM1 <b>Sect IX QW-432:</b> F-No. 6 <b>17632-A:</b> T 42 4 P M21 1 H5 <b>A 5.20:</b> E 71T-1M -J H4 <b>A 5.36:</b> E 71T1-M21 A4-H4	T 500-640 MPa Y ~ 460 MPa E > 22% I ~ 50J (-40 °C)	C < 0,08 Mn ~ 1,3 Si ~ 0,5 P < 0,015 S < 0,015	<b>AA R400</b> is a <b>seamless rutile flux cored</b> wire with remarkable <b>stable arc and no spatters</b> . Excellent weld puddle manipulation with fast freezing slag, superior out-of-position welding also at higher current, recommended for shipbuilding. Particularly suited for all-position welding on ceramic backing. Extreme low spatter loss, easy slag removal. Low hydrogen content <b>HD&lt;3 ml/100g</b> even after long storage.
<b>CEWELD AA R460</b>	<b>9606-1:</b> FM1 <b>Sect IX QW-432:</b> F-No. 6 <b>17632-A:</b> T 46 4 P M21 1 H5 T 46 2 P C1 1 H5 <b>A 5.20:</b> E71T-1M /1C-J H4 <b>A 5.36:</b> E71T1-M21 A4-CS1-H4 E71T1-C-A0-CS1-H4	<b>M21</b> T 530-680 MPa Y ~ 480 MPa E > 22% I ~ 70J (-40 °C) <b>CO2</b> T 500-640 MPa Y > 420 MPa E > 22% I ~ 70J (-20 °C)	C < 0,08 Mn ~ 1,3 Si ~ 0,5 P < 0,015 S < 0,015	<b>AA R460</b> is a <b>seamless rutile flux cored</b> wire with remarkable <b>stable arc and no spatters</b> . Excellent weld puddle manipulation with fast freezing slag, superior out-of-position welding also at higher current. <b>Using temperature down to -40 °C</b> . Particularly suited for <b>MAG-orbital welding (&lt; 355MPa)</b> and <b>all-position welding on ceramic backing</b> . Extreme low spatter loss, easy slag removal. Low hydrogen content <b>HD&lt;3 ml/100g</b> even after long storage.
<b>CEWELD AA R460 LT</b>	<b>9606-1:</b> FM1 <b>Sect IX QW-432:</b> F-No. 6 <b>17632-A:</b> T 46 6 P M21 1 H5 T 46 4 P C1 1 H5 <b>A 5.20:</b> E71T-1M /1C-J H4 <b>A 5.36:</b> E71T1-M21 A8-CS1-H4 E71T1-C-A0-CS1-H4	<b>M21</b> T 530-680 MPa Y ~ 460 MPa E > 22% I ~ 70J (-60 °C) <b>CO2</b> T 530-680 MPa Y > 460 MPa E > 22% I ~ 70J (-40 °C)	C < 0,08 Mn ~ 1,3 Si ~ 0,5 P < 0,015 S < 0,015 Ni < 0,5	<b>AA R460 LT</b> is a <b>seamless rutile flux cored</b> wire with remarkable stable arc and no spatters. Excellent weld puddle manipulation with fast freezing slag, superior <b>out-of-position welding</b> also at higher currents. Using temperature <b>down to -60 °C</b> . Particularly suited for <b>MAG-orbital welding (&lt; 355MPa)</b> and all-position welding on ceramic backing. Extreme low spatter loss, easy slag removal. Low hydrogen content <b>HD&lt;3 ml/100g</b> even after long storage.
<b>CEWELD AA R500</b>	<b>9606-1:</b> FM1 <b>Sect IX QW-432:</b> F-No. 6 <b>17632-A:</b> T 50 6 1Ni P M21 1 H5 T 46 4 1Ni P C1 1 H5 <b>A 5.29:</b> E81T1-Ni1M-J H4 <b>A 5.36:</b> E81T1-M21A8-Ni1-H4 E81T1-C1A4-Ni1-H4	<b>M21</b> T 560-720 MPa Y > 500 MPa E > 22% I ~ 70J (-60 °C) <b>CO2</b> T 530-680 MPa Y > 460 MPa E > 22% I ~ 70J (-40 °C)	C < 0,08 Mn ~ 1,4 Si ~ 0,5 P < 0,015 S < 0,015 Ni ~ 0,9	<b>AA R500</b> is a <b>seamless rutile flux cored</b> wire that offers excellent modelling ability, therefore excellently suitable for positional welding at high currents. The weld deposit shows reliable impact properties down to <b>-60 °C</b> . Particularly suitable for <b>MAG-orbital welding (&lt; 420MPa)</b> and for welding on ceramics in all positions. Low spatter losses, easily removable slag. <b>CTOD tested at -20 °C</b> . Extreme low spatter loss, easy slag removal. Low hydrogen content <b>HD&lt;3 ml/100g</b> even after long storage.

## CORED WIRE

TYPE	EN -ISO and ASME -AWS	MECHANICAL PROPERTIES	ANALYSIS	APPLICATION
CEWELD AA R500 SR	9606-1: FM1 Sect IX QW-432: F-No. 6 17632-A: T 50 6 1Ni P M21 1 H5 A 5.29: E81T1-Ni1M-J H4 A 5.36: E81T1-M21A8-Ni1-H4	T 560-720 MPa Y > 500 MPa E > 22% I ~ 70J (-60 °C) after PWHT T 530-680 MPa Y > 460 MPa E > 22% I ~ 50J (-60 °C)	C < 0,08 Mn ~ 1,4 Si ~ 0,5 P < 0,015 S < 0,015 Ni ~ 0,9	AA R500 SR is a <b>seamless rutile cored wire</b> and has excellent modelling ability, therefore excellent forced position welding in all positions at high amperage. <b>Down to -60 °C</b> very good impact values are achieved also with <b>very good PWHT results</b> . Particularly suitable for welding on ceramics in all positions. Low spatter losses, easily removable slag. <b>CTOD tested to -20 °C</b> . Low hydrogen content <b>HD&lt;3 ml/100g</b> even after long storage.
CEWELD AA R500 PIPE	9606-1: FM1 Sect IX QW-432: F-No. 6 17632-A: T 50 4 Mn1Ni P M21 1 H5 (T 55 4 Mn1Ni P M21 1 H5) A 5.36: E81T1-M21A4-Ni1-H4 (E91T1-M21A8-Ni1-H4)	T 560-720 MPa Y > 540 MPa E ~ 20% I ~ 90J (-40 °C)	C < 0,08 Mn ~ 1,5 Si ~ 0,5 P < 0,015 S < 0,015 Ni ~ 0,9	AA R500 PIPE is a <b>seamless rutile cored wire with</b> very good modeling ability, therefore <b>excellent all-position welding</b> with higher currents. For use <b>down to -40 °C</b> . Particularly suitable for MAG orbital welding (< 500MPa) and for welding on ceramics in all positions, made for welding with high heat input. Low spatter losses and remarkably easy slag removal. Low hydrogen content <b>HD&lt;3 ml/100g</b> even after long storage. (T 55 4 Mn1Ni B M21 1 H5 and E91T1-M21A8-Ni1-H4 with < 1.5 KJ/mm )
CEWELD AA R690	9606-1: FM2 Sect IX QW-432: F-No. 6 18276-A: T 69 6 Z P M21 1 H5 A 5.28: E 111 C-K4 H4 A 5.36: E111T1-M21A4-G-H4	T 770-940 MPa Y > 690 MPa E > 18% I ~ 80J (-40 °C) I ~ 50J (-60 °C)	C < 0,05 Mn ~ 1,6 Si ~ 0,4 P < 0,01 S < 0,01 Cr ~ 0,5 Ni ~ 2,2 Mo ~ 0,5	AA R690 is a <b>seamless rutile flux cored wire</b> with remarkable crack resistant weld metal. Excellent modeling ability, therefore excellent position welding. Particularly well suited for MAG orbital welding and for welding on ceramics in all positions. Operating temperature <b>down to -60 °C</b> . Low spatter loss, good slag removal. Stable mechanical quality values up to a heat input of <b>E&lt;12 kJ/cm</b> . Low hydrogen content <b>HD&lt;3 ml/100g</b> even after long storage. <b>CTOD tested to -20 °C</b> .
5. RUTILE FLUX CORED WIRE FOR CREEP RESISTANT STEEL				
CEWELD AA R Mo	9606-1: FM3 Sect IX QW-432: F-No. 6 17634-A: T MoL P M21 1 H5 A 5.29: E81T1-A1M H4 A 5.36: E81T1-M21PY-A1-H4	T 550-680 MPa Y > 460 MPa E > 22% I ~ 50J (+20 °C)	C < 0,05 Mn ~ 1,3 Si ~ 0,7 P < 0,015 S < 0,015 Mo ~ 0,5	AA RMo is a <b>seamless rutile flux cored wire</b> with excellent weld puddle manipulation, superior <b>out-of-position welding</b> . Particularly suited for MAG orbital welding applications and all-position welding on ceramic backing. Low spatter loss, easy slag removal. Suitable for economic welding of <b>Mo-steels up to 500 °C</b> . Low hydrogen content <b>HD&lt;3 ml/100g</b> even after long storage. <b>Typical: 15Mo3, 16Mo3, A 204 Gr. A - C, ASTM A106 gr. A-B-C.</b>
CEWELD AA R CrMo1	9606-1: FM3 Sect IX QW-432: F-No. 6 17634-A: T CrMo1 P M21 1 H5 A 5.29: E81T1-B2M H4 A 5.36: E81T1-M21PY-B2-H4	T 550-740 MPa Y > 470 MPa E > 20% I ~ 50J (-40 °C)	C < 0,05 Mn ~ 1,4 Si ~ 0,3 P < 0,015 S < 0,015 Cr ~ 1,1 Mo ~ 0,5	AA RCrMo1 is a <b>seamless rutile flux cored wire</b> with excellent weld puddle manipulation, superior <b>out-of-position welding</b> . Particularly suited for MAG orbital welding applications and all-position welding on ceramic backing. Low spatter loss, easy slag removal. Suitable for economic welding of <b>CrMo-steels up to 550 °C</b> . Low hydrogen content <b>HD&lt;3 ml/100g</b> even after long storage. <b>Typical: 13CrMo44, 13CrMo4-5, A 387 Gr. 11-12, 24CrMo5, GS 17CrMo55, GS 22CrMo54, G 17CrMo5-5, G22CrMo5-4</b>
6. RUTILE FLUX CORED WIRE FOR WEATHER RESISTANT STEEL				
CEWELD AA R Corten	9606-1: FM1 Sect IX QW-432: F-No. 6 17632-A: T 46 2 Z P M21 H5 A 5.29: E81T1-G H4 A 5.36: E81T1-M21 A4-G-H4	T 530-680 MPa Y > 460 MPa E > 22% I ~ 70J (-40 °C)	C < 0,05 Mn ~ 1,5 Si ~ 0,7 P < 0,01 S < 0,01 Cr ~ 0,5 Ni ~ 1,2 Cu ~ 0,5	AA R Corten is a <b>seamless rutile flux cored wire</b> which has an excellent weld puddle manipulation with fast freezing slag, superior <b>out-of-position welding</b> also at higher currents. This wire offers a unique welding deposit with more than <b>1% nickel and 0,5% Cu</b> . Low hydrogen content <b>HD&lt;3 ml/100g</b> even after long storage.
7. BASIC FLUX CORED WIRE FOR NON-ALLOYED AND FINE GRAIN STEEL				
CEWELD AA B460	9606-1: FM1 Sect IX QW-432: F-No. 6 17632-A: T 46 6 B M21 3 H5 T 42 4 B C1 3 H5 A 5.20: E70T5-1M / 1C-J H4 A 5.36: E71T5-M21 A8-CS1-H4 E71T5-1C-A4-CS1-H4	<b>M21</b> T 530-680 MPa Y > 460 MPa E > 22% I ~ 70J (-60 °C) <b>CO2</b> T 500-640 MPa Y > 420 MPa E > 22% I ~ 70J (-40 °C)	C < 0,08 Mn ~ 1,4 Si ~ 0,5 P < 0,015 S < 0,015	AA B460 is a <b>seamless basic flux cored wire</b> with <b>absolutely crack resistant</b> weld metal conditioned by the basic slag system. High mechanical properties <b>also for single-sided welding</b> on ceramics. <b>X-ray-proof</b> seams with low spatter loss. Suitable for high carbon steels and welding critical mixed combinations. Low hydrogen content <b>HD&lt; 3 ml/100g</b> even after long storage. <b>Metallurgical ideal filler metal for repair and production welding as well as for buffer layers.</b>
CEWELD AA B500	9606-1: FM1 Sect IX QW-432: F-No. 6 17632-A: T 50 6 1Ni B M21 1 H5 A 5.29: E 80 T5-Ni1-J H4 A 5.36: E80T5-M21A8-Ni1-H4 E80T5-C1A4-Ni1-H4	T 560-720 MPa Y > 500 MPa E > 20% I ~ 80J (-60 °C)	C < 0,08 Mn ~ 1,5 Si ~ 0,7 P < 0,015 S < 0,015 Ni ~ 0,9	AA B500 is a <b>seamless high basic flux cored wire</b> for extreme offshore requirements at sub zero temperatures <b>down to - 60 °C</b> . Excellent welding properties. Therefore, suitable for the economic processing of high-strength, low temperature fine-grained structural steels with <b>Rp0,2 &gt; 500 MPa</b> . Low hydrogen content <b>HD&lt; 3 ml/100g</b> even after long storage.

TYPE	EN -ISO and ASME -AWS	MECHANICAL PROPERTIES	ANALYSIS	APPLICATION
CEWELD AA B550	9606-1: FM2 Sect IX QW-432: F-No. 6 18276-A: T 55 6 1NiMo B M21 1 H5 A 5.29: E80T5-K1M-J H4 A 5.36: E80T5-M21A4-K1-H4	T 640-820 MPa Y > 550 MPa E ~ 20% I ~ 80J (-60 °C)	C < 0,05 Mn ~ 1,2 Si ~ 0,4 P < 0,01 S < 0,01 Ni ~ 1,1 Mo ~ 0,3	AA B550 is a <b>seamless high basic flux cored wire</b> for extreme requirements at sub zero temperatures <b>down to -60 °C</b> . Excellent welding properties. Yield strength > <b>550 MPa</b> . Low hydrogen content <b>HD &lt; 3 ml/100g</b> even after long storage. <b>Typical for: 15NiCuMoNb5, 17MnMoV53, (WB36) 20MnMoNi4-5</b>
CEWELD AA B690	9606-1: FM2 Sect IX QW-432: F-No. 6 18276-A: T 69 6 Mn2NiCrMo B M21 3 H5 A 5.29: E110T5-K4M H4 A 5.36: E110T5-M21A8-K4-H4	T 770-940 MPa Y > 690 MPa E ~ 18% I ~ 75J (-60 °C)	C < 0,05 Mn ~ 1,6 Si ~ 0,4 P < 0,01 S < 0,01 Cr ~ 0,5 Ni ~ 2,2 Mo ~ 0,5	AA B690 is a <b>seamless high basic flux cored wire</b> that offers a <b>absolute crack resistant</b> weld metal conditioned by the high-basic slag. Therefore, suitable for the economic processing of <b>high-strength, low temperature fine-grained structural steels with Yield strength &gt;690 MPa</b> . X-ray-proof weld deposit with low spatter loss. Stable mechanical properties of the weld metal also at high heat input <b>up to E&lt;18 kJ/cm</b> . Low hydrogen content <b>HD &lt; 3 ml/100g</b> even after long storage.
CEWELD AA B960	9606-1: FM2 Sect IX QW-432: F-No. 6 18276-A: T 89 4 Mn 2Ni1CrMo B M21 3 H5 A 5.36: E130T5-M21A4-K4-H4	T 940-1180 MPa Y ~ 960 MPa E ~ 16% I ~ 47J (-40 °C)	C < 0,05 Mn ~ 1,6 Si ~ 0,4 P < 0,01 S < 0,01 Cr ~ 0,5 Ni ~ 2,2 Mo ~ 0,5	AA B960 is a <b>seamless high basic flux cored wire</b> that offers a <b>absolute crack resistant</b> weld metal conditioned by the high-basic slag. Therefore, suitable for the economic processing of high-strength, low temperature fine-grained structural steels with <b>Yield strength &gt;960 MPa</b> . X-ray-proof weld deposit with low spatter loss. Stable mechanical properties of the weld metal also at high heat input up to <b>E&lt;18 kJ/cm</b> . Low hydrogen content <b>HD &lt; 3 ml/100g</b> even after long storage. <b>After PWHT Yield strength &lt; 690 MPa</b> <b>Typical for: 25CrMo4, 34CrMo4, 42CrMo4, 28NiCrMo44</b>
<b>8. BASIC FLUX CORED WIRE FOR CREEP RESISTANT STEEL</b>				
CEWELD AA B Mo	9606-1: FM4 Sect IX QW-432: F-No. 6 17634-A: T Mo B M21 3 H5 A 5.29: E80T5-G H4 A 5.36: E80T5-M21P4-A1-H4	AW und SR T 550-690 MPa Y > 460 MPa E > 24% I ~ 50J (-40 °C)	C < 0,05 Mn ~ 1,3 Si ~ 0,7 P < 0,015 S < 0,015 Mo ~ 0,5	AA BMo is a <b>seamless basic flux cored wire</b> with excellent weld puddle manipulation. Low spatter loss, easy slag removal. Suitable for economic welding of <b>0,5Mo-steels up to 500 °C</b> . Due to the seamless production process the hydrogen content is below <b>HD&lt;3ml/100g</b> weld metal even after long storage. <b>Typical for: 15Mo3, 16Mo3 typical, A 204 Gr. A - C, ASTM A106 gr. A-B-C</b>
CEWELD AA B CrMo1	9606-1: FM4 Sect IX QW-432: F-No. 6 17634-A: T CrMo1 B M21 3 H5 A 5.29: E80T5-B2M H4 A 5.36: E80T5-M21PY-B2-H4	AW und SR T 550-740 MPa Y > 470 MPa E > 20% I ~ 50J (-40 °C)	C < 0,05 Mn ~ 1,4 Si ~ 0,3 P < 0,015 S < 0,015 Cr ~ 1,1 Mo ~ 0,5	AA BCrMo1 is a <b>seamless basic flux cored wire</b> with excellent weld puddle manipulation. Low spatter loss, easy slag removal. Suitable for economic welding of <b>CrMo1-steels up to 550 °C</b> . Due to the seamless production process the hydrogen content is below <b>HD&lt;3ml/100g</b> weld metal even after long storage. <b>Typical for: 13CrMo44, 13CrMo4-5, A 387 Gr. 11-12, 24CrMo5, GS 17CrMo55, GS 22CrMo54, G 17CrMo5-5, G22CrMo5-4</b>
CEWELD AA B CrMo2	9606-1: FM4 Sect IX QW-432: F-No. 6 17634-A: T CrMo2 B M21 3 H5 A 5.29: E90T5-B3M H4 A 5.36: E90T5-M21PY-B3-H4	SR T 620-780 MPa Y > 540 MPa E > 18% I ~ 50J (-40 °C)	C < 0,05 Mn ~ 1,4 Si ~ 0,3 P < 0,015 S < 0,015 Cr ~ 2,5 Mo ~ 1,0	AA BCrMo2 is a <b>seamless basic flux cored wire</b> with excellent weld puddle manipulation. Low spatter loss, easy slag removal. Suitable for economic welding of <b>CrMo2-steels up to 550 °C</b> . Due to the seamless production process the hydrogen content is below <b>HD&lt;3ml/100g</b> weld metal even after long storage. <b>Typical for: 10CrMo9-10, 10CrSiMoV7, 12CrMo9-10, A 387, CrMo2</b>
CEWELD AA B CrMo1V	9606-1: FM4 Sect IX QW-432: F-No. 6 17634-A: T CrMo1 B M21 3 H5 A 5.29: E80T5-B2M H4 A 5.36: E80T5-M21PY-B2-H4	SR T 650-780 MPa Y > 500 MPa E > 15% I ~ 50J (+20 °C)	C < 0,10 Mn ~ 0,9 Si ~ 0,3 P < 0,015 S < 0,015 Cr ~ 1,1 Mo ~ 1,2 V ~ 0,25	AA BCrMo1V is a <b>seamless basic flux cored wire</b> with excellent weld puddle manipulation. Low spatter loss, easy slag removal. Extremely crack resistant. Suitable for economic welding of <b>CrMoV-steels up to 550 °C</b> . Due to the seamless production process the hydrogen content is below <b>HD&lt;3ml/100g</b> weld metal even after long storage. <b>Typical for: GS-17CrMoV 5 11, 21CrMoV 5 11</b>

## CORED WIRE

TYPE	EN -ISO and ASME -AWS	MECHANICAL PROPERTIES	ANALYSIS	APPLICATION
------	-----------------------	-----------------------	----------	-------------

## 9. BASIC FLUX CORED WIRE FOR WEATHER RESISTANT STEEL

CEWELD AA B Corten	9606-1: FM1 Sect IX QW-432: F-No. 6 17632-A: T 46 2 Z B M21 3 H5 A 5.29: E80T5-G H4 A 5.36: E80T5-M21 A4-G-H4	T 550-680 MPa Y > 470 MPa E > 22% I ~ 70J (-40 °C)	C < 0,05 Mn ~ 1,5 Si ~ 0,7 P < 0,01 S < 0,01 Cr ~ 0,5 Ni ~ 1,2 Cu ~ 0,5	AA B Corten is a seamless basic flux cored wire have a excellent weld puddle. This wire offers a unique welding deposit with more than 1% nickel and 0,5% Cu due to the seamless production process the hydrogen content is below HD<3ml/100g weld metal even after long storage.
-----------------------	--	---	--	---

## 10. SELF SHIELDING CORED WIRE FOR NON-ALLOYED AND FINE GRAIN STEEL

CEWELD OA S-71-TGS	9606-1: FM1 Sect IX QW-432: F-No. 6 17632-A: T 42 Z W N 1 H15 A 5.20: E 71T-GS	T 500-640 MPa Y > 420 MPa E > 20%	C < 0,15 Mn ~ 0,9 Si ~ 0,4 P < 0,015 S < 0,015 Al ~ 1,4	OA S-71-TGS can be used for outdoor welding and is applicable for old and rusty base-materials, fair mechanical properties and stable arc for welding in all positions without shielding gas.
CEWELD OA S-71-T8	9606-1: FM1 Sect IX QW-432: F-No. 6 17632-A: T 42 2 W N 2 H10 A 5.20: E 71 T-8JD H8	T 500-640 MPa Y > 420 MPa E > 22% I ~ 75J (-20 °C)	C < 0,19 Mn ~ 0,55 Si ~ 0,2 P < 0,009 S < 0,009 Al ~ 0,6	OA S-71-T8 is able to weld out of position at extreme currents and offers a low hydrogen weld deposit. Excellent slag removal and shielding gas is not required. High impact strength at low temperatures combined with excellent mechanical properties within a wide range of heat inputs. Applicable under AWS D1.8 for use on 'Demand Critical welds'.
CEWELD OA S-70-T4R	9606-1: FM1 Sect IX QW-432: F-No. 6 17632-A: T 38 Z W N 3 H15 A 5.20: E 70 T-4	T 470-600 MPa Y > 380 MPa E > 22%	C < 0,2 Mn ~ 0,55 Si ~ 0,2 P < 0,002 S < 0,002 Al ~ 1,3	OA S-70-T4R is for welding outside in case high speed welding is required and shielding gas is not possible or difficult. Suitable for C-Mn steels such as rails, fabrication of machinery, steel framed buildings and or heavy equipment repair. Recommended for butt assembly of rails and crossings.

TYPE	EN -ISO and ASME -AWS	MECHANICAL PROPERTIES	ANALYSIS	APPLICATION
------	-----------------------	-----------------------	----------	-------------

11. CORED WIRE FOR STAINLESS STEEL				
<b>CEWELD AA M 410 NiMo</b>	<b>ISO 17633:</b> T 13 4 / T 410 NiMo <b>A 5.22:</b> E 410 NiMoT0-4	T > 750 MPa Y > 500 MPa E > 15% I ~ 65J (-20 °C) I ~ 55J (-20 °C)  38 -42 HRC	C < 0,06 Mn < 1,5 Si < 1,0 Cr 11 - 14,5 Ni 3,0 - 5,0 Mo 0,4 - 1,0 Nb - Cu < 0,5	<b>AAM 410NiMo</b> is a Cr-Ni-Mo- alloyed, gas-shielded metal-cored wire electrode for cladding. The corrosion resistant deposit offers a medium hardness and is resistant against metal-metal wear and high surface pressure. He is steel mill rollers, thermoshock resistant and suitable for Francis and Pelton turbines. Used in steam power plants for its excellent resistance to cavitation and stress corrosion cracking <b>Water and steam turbine parts of the same kind, thermoshock and high heat resistant. 1.4313, 1.4002, (G)X5CrNi(Mo) 13 4, X6CrAl 13, Grade CA 6 NM.</b>
<b>CEWELD AA 307</b>	<b>9606-1: FM5 Sect IX QW-432: F-No. 6 17633-A:</b> T 18 8 Mn R M21 3 <b>A 5.22:</b> ~ E 307 T 0-4	T > 500 MPa Y > 350 MPa E > 25% I ~ 40J (-100 °C)	C < 0,20 Mn 4,5 - 7,5 Si < 1,2 Cr 17 - 20 Ni 7,0 - 10 Mo 0,3 Cu 0,5	<b>AA 307</b> is rutile flux cored wire applicable for welding stainless steel to low alloyed steels ( <b>dissimilar welds</b> ), <b>buffer layers</b> before hard facing, rails crossings, <b>Armor plate</b> , austenitic manganese steels and other <b>difficult to weld steels</b> .
<b>CEWELD AA 307P</b>	<b>9606-1: FM5 Sect IX QW-432: F-No. 6 17633-A:</b> T 18 8 Mn P M21/C1 1 <b>A 5.22:</b> ~E 307 T1-4 ~E 307 T1-1	T > 500 MPa Y > 475 MPa E > 25% I ~ 40J (-100 °C)  180 HB Strain hardening 400 HB	C < 0,20 Mn 4,5 - 7,5 Si < 1,2 Cr 17 - 20 Ni 7,0 - 10 Mo 0,3 Cu 0,5	<b>AA 307P</b> is a rutile flux cored wire with fast freezing slag, suitable for positional welding. Applicable for stainless steel <b>dissimilar welding</b> and buffer layers before hard facing, rails crossings, Armor plate, austenitic manganese steels, exhaust systems (type 409, 304) and difficult to weld steels such as: <b>42CrMo4, C45, 42MnV7</b> , tool steels etc.
<b>CEWELD AA 308L</b>	<b>9606-1: FM5 Sect IX QW-432: F-No. 6 17633-A:</b> T 19 9 L R M21/C1 3 <b>A 5.22:</b> E 308 LT0-4 E 308 LT0-1	T > 510 MPa Y > 320 MPa E > 30% I ~ 40J (-100 °C)	C < 0,04 Mn < 2,0 Si < 1,2 Cr 18 - 21 Ni 9,0 - 11 Mo 0,3 Cu 0,5	<b>AA 308L</b> is a rutile flux cored wire for welding stainless steel types with an alloy content between <b>16 to 21% Cr and 8 to 13 % Ni</b> , for both stabilized and un-stabilized types. High weld metal quality and an attractive bead appearance. <b>W.no: 1.4306, 1.4301, 1.4541, 1.4550, 1.4311, 1.4546, 1.4312, 1.4300, 1.4312, 1.4371, 1.4541, 1.4543, 1.4550, 1.4452 ; AISI 202, 302, 304L, 304, 305, 321, 347, 304 LN ASTM A320 Grade B8C/D, 302</b>
<b>CEWELD AA 308LP</b>	<b>9606-1: FM5 Sect IX QW-432: F-No. 6 17633-A:</b> T 19 9 L P M21 1 <b>A 5.22:</b> E 308 LT1-4 E 308 LT1-1	T > 510 MPa Y > 320 MPa E > 30% I ~ 40J (-100 °C)	C < 0,04 Mn < 2,0 Si < 1,2 Cr 18 - 21 Ni 9,0 - 11 Mo 0,3 Cu 0,5	<b>AA 308LP</b> is a rutile flux cored wire with fast freezing slag, suitable for positional welding. Stainless steel types with an alloy content between <b>16 to 21% Cr and 8 to 13 % Ni</b> , for both stabilized and un-stabilized types. High weld metal quality and an attractive bead appearance. <b>W.no: 1.4306, 1.4301, 1.4541, 1.4550, 1.4311, 1.4546, 1.4312, 1.4300, 1.4312, 1.4371, 1.4541, 1.4543, 1.4550, 1.4452</b>
<b>CEWELD AA 308H</b>	<b>9606-1: FM5 Sect IX QW-432: F-No. 6 17633-A:</b> T 19 9 H R M21 3 <b>A 5.22:</b> E 308 HT0-4 E 308 HT0-1	T > 550 MPa Y > 350 MPa E > 30% I ~ 80J (20 °C)	C 0,04-0,08 Mn < 1,0 Si 1,0 - 2,5 Cr 18 - 21 Ni 9,0 - 11 Mo 0,3 Cu 0,5	<b>AA 308H</b> is a rutile flux cored wire with <b>high carbon</b> content for welding stainless steel types with an alloy content between <b>16 to 21% Cr and 8 to 13 % Ni</b> , for both stabilized and un-stabilized types. High weld metal quality and an attractive bead appearance. <b>W.no: 1.4306, 1.4301, 1.4541, 1.4550, 1.4311, 1.4546, 1.4312, 1.4300, 1.4312, 1.4371, 1.4541, 1.4543, 1.4550, 1.4452</b>
<b>CEWELD AA 309L</b>	<b>9606-1: FM5 Sect IX QW-432: F-No. 6 17633-A:</b> T 23 12 L R M21 3 <b>A 5.22:</b> E 309 LT0-1 E 309 LT0-4	T > 510 MPa Y > 320 MPa E > 25% I ~ 55J (20 °C)	C < 0,04 Mn < 2,5 Si < 1,2 Cr 22 - 25 Ni 11 - 14 Mo 0,3 Cu 0,5	<b>AA 309L</b> is a rutile flux cored wire for welding <b>dissimilar steels</b> and <b>13 to 18%Cr stainless steels</b> . Also suitable for welding the first layer on low carbon steel to obtain a AISI 304 clad layer. Buffer layers before hard facing, dissimilar joints between ferritic and austenitic steels and or <b>difficult to weld steels</b> such as: <b>42CrMo4, C45, 42MnV7</b> , tool steels, heat resistant steels etc.
<b>CEWELD AA 309LP</b>	<b>9606-1: FM5 Sect IX QW-432: F-No. 6 17633-A:</b> T 23 12 L P M21 1 <b>A 5.22:</b> E 309 LT1-1 E 309 LT1-4	T > 510 MPa Y > 320 MPa E > 25% I ~ 55J (20 °C)	C < 0,04 Mn < 2,5 Si < 1,2 Cr 22 - 25 Ni 11 - 14 Mo 0,3 Cu 0,5	<b>AA 309LP</b> is a rutile flux cored wire with fast freezing slag for <b>positional welding</b> of dissimilar steels and <b>13 to 18%Cr stainless steels</b> . Also suitable for welding the first layer on low carbon steel to obtain a AISI 304 clad layer. Buffer layers before hard facing, dissimilar joints between ferritic and austenitic steels and or difficult to weld steels such as: <b>42CrMo4, C45, 42MnV7</b> , tool steels, heat resistant steels etc.
<b>CEWELD AA 309LNb</b>	<b>9606-1: FM5 Sect IX QW-432: F-No. 6 17633-A:</b> TZ 23 12 LNb R M21 1 <b>A 5.22:</b> E 309LCb T0-1 E 309LCb T0-4	T > 550 MPa Y > 350 MPa E > 25% I ~ 50J (20 °C)	C < 0,08 Mn 1,5-2,5 Si < 1,0 Cr 22 - 25 Ni 11 - 14 Mo 0,3 Nb+Ta- 10xC Cu < 0,5	<b>AA 309LNb</b> is a rutile flux cored wire for positional welding of dissimilar steels and <b>13 to 18%Cr stainless steels</b> . Cladding mild and low alloyed steels in offshore and or chemical plants in case AISI 347 or AISI 321 are required as clad layer.



## CORED WIRE

TYPE	EN -ISO and ASME -AWS	MECHANICAL PROPERTIES	ANALYSIS	APPLICATION
CEWELD AA 309LMo	9606-1: FM5 Sect IX QW-432: F-No. 6 17633-A: T 23 12 2 L R C1/M21 3 A 5.22: E 309LMoT0-1 E 309LMoT0-4	T > 550 MPa Y > 350 MPa E > 25% I ~ 50J (-20 °C)	C < 0,04 Mn < 2,5 Si < 1,2 Cr 22 - 25 Ni 11 - 14 Mo 2,0 - 3,0 Cu 0,5	<b>AA 309LMo</b> is a <b>rutile flux cored wire</b> producing a stable spatter free arc with a bright- and smooth weld surface. Easy removable slag. The weld deposit shows low carbon and about 23%Cr-13%Ni-2.3%Mo. <b>AA 309LMo</b> is recommended for overlay welding obtaining a <b>AISI 316</b> weld deposit in one layer on mild steel. <b>W.No: 1.4401, 1.4404, 1.4406, 1.4410, 1.4437, 1.4571, 1.4580</b>
CEWELD AA 309LMoP	9606-1: FM5 Sect IX QW-432: F-No. 6 17633-A: T 23 12 2 L P C1/M21 1 A 5.22: E 309LMoT1-1 E 309LMoT1-4	T > 550 MPa Y > 350 MPa E > 25% I ~ 70J (-40 °C)	C < 0,04 Mn < 2,5 Si < 1,2 Cr 22 - 25 Ni 11 - 14 Mo 2,0 - 3,0 Cu 0,5	<b>AA 309 LMoP</b> is a <b>rutile flux cored wire</b> with fast freezing slag for positional welding. Very stable, spatter free arcs producing bright, smooth weld bead surfaces and self releasing slag for welding in all positions. The weld deposit shows low carbon and about 23%Cr-13%Ni-2.3%Mo. <b>AA 309LMo</b> is recommended for overlay welding obtaining a <b>AISI 316</b> weld deposit in one layer on mild steel. <b>W.No: 1.4401, 1.4404, 1.4406, 1.4410, 1.4437, 1.4571, 1.4580</b>
CEWELD AA 310	9606-1: FM5 Sect IX QW-432: F-No. 6 17633-A: T 25 20 R C1/M21 3 A 5.22: E 310T0-1 E 310T0-4	T > 550 MPa Y > 350 MPa E > 20% I ~ 50J (-20 °C)	C 0,02-0,06 Mn 1,0 - 5,0 Si < 1,2 Cr 23 - 27 Ni 18 - 22 Mo < 0,3 Cu < 0,5	<b>AA 310</b> is a <b>rutile flux cored wire</b> for welding <b>heat-resistant austenitic steels</b> of the <b>25% Cr, 20% Ni</b> types. <b>AA 310</b> has good general oxidation resistance, especially at high temperatures, due to its high Cr content. The alloy is <b>fully austenitic</b> and is therefore <b>sensitive to hot cracking</b> . Applicable stainless- and high temperature steels: <b>W.no: : 1.4826, 1.4828, 1.4835, 1.4837, 1.4840, 1.4841, 1.4845, 1.4846, 1.4847, 1.4848, 1.4710, 1.4713, 1.4724, 1.4726, 1.4742, 1.4745, 1.4762</b>
CEWELD AA 312	9606-1: FM5 Sect IX QW-432: F-No. 6 17633-A: T 29 9 R M21 3 A 5.22: E 312T0-4	T > 650 MPa Y > 450 MPa E > 15%	C < 0,15 Mn < 2,5 Si < 1,2 Cr 27 - 31 Ni 8,0 - 12 Mo < 0,3 Cu < 0,5	<b>AA 312</b> is a <b>rutile flux cored wire</b> for welding unknown or difficult to weld steels. AA 312 offers high strength with remarkable weldability and excellent crack resistance. Stainless steels, C45, C60, manganese steel, Spring steel, <b>Buffer layers 25CrMo4, 42CrMo4, 50CrMo4, 42MnV7, 1.7218, 1.7225, 1.7228, 1.5223, AISI 4130, 4140, 4150 HSS</b> (high speed steel), cast steel etc.
CEWELD AA 316L	9606-1: FM5 Sect IX QW-432: F-No. 6 17633-A: T 19 12 3 L R M21 3 (1) A 5.22: E 316LT0-1 E 316LT0-4	T > 510 MPa Y > 320 MPa E > 25% I ~ 40J (-120 °C)	C < 0,04 Mn < 2,0 Si < 1,2 Cr 17 - 20 Ni 10 - 13 Mo 2,5 - 3,0 Cu < 0,5	<b>AA 316L</b> is a <b>rutile flux cored wire</b> intended for welding 18/8/3 CrNiMo steels. Easy slag removal with high productivity and a bright weld seam without spatters making AA 316L suitable for a wide range of applications . Excellent for use on ceramic backing. X-ray proof weld seams. Better wetting and productivity compared to solid wires. <b>W.no: 4583,1.4435,1.4436,1.4404, 1.4406, 1.4408,1.4401,1.4571,1.4580,1.4406</b>
CEWELD AA 316LP	9606-1: FM5 Sect IX QW-432: F-No. 6 17633-A: T 19 12 3 L P M21 1 A 5.22: E 316LT1-1 E 316LT1-4	T > 510 MPa Y > 320 MPa E > 25% I ~ 40J (-40°C)	C < 0,04 Mn < 2,0 Si < 1,2 Cr 17 - 20 Ni 10 - 13 Mo 2,5 - 3,0 Cu < 0,5	<b>AA 316LP</b> is a <b>rutile flux cored wire</b> with fast freezing slag for positional welding. Intended for welding 18/8/3 CrNiMo steels. Easy slag removal with high productivity and a bright weld seam without spatters making AA 316 LP suitable for a wide range of applications . Excellent for use on ceramic backing. X-ray proof weld seams. Better wetting and productivity compared to solid wires. <b>W.no: 4583,1.4435,1.4436,1.4404, 1.4406, 1.4408,1.4401,1.4571,1.4580,1.4406</b>
CEWELD AA 317L	9606-1: FM5 Sect IX QW-432: F-No. 6 17633-A: TZ 19 13 4 L R M21/C1 3 A 5.22: E 317LT0-1 E 317LT0-4	T > 550 MPa Y > 350 MPa E > 25% I ~ 40J (-40°C)	C < 0,04 Mn 1 - 5 Si < 1,2 Cr 17 - 20 Ni 12 - 15 Mo 3,0 - 4,5 Cu < 0,5 N 0,08-0,20	<b>AA 317L</b> is a <b>rutile flux cored wire</b> with easy removable slag support for high productivity welding. Smooth drop transfer and stable arc with no spatter losses. Excellent weld metal quality and X-ray soundness. <b>W.no:1.4429, 1.4435, 1.4438, AISI 316L, 316LN, 317LN, 317L</b>
CEWELD AA 318	9606-1: FM5 Sect IX QW-432: - 17633-A: T 19 12 3 Nb P M21 1	T > 550 MPa Y > 350 MPa E > 25% I ~ 60J (0°C)	C < 0,08 Mn < 2,0 Si < 1,2 Cr 17 - 20 Ni 10 - 13 Mo 2,5 - 3,0 Nb+Ta 8xC < 1,1 Cu 0,5	<b>AA 318</b> is a <b>rutile flux cored wire</b> with <b>fast freezing</b> slag, support for high productivity welding. Developed for welding stabilized <b>CrNi(N)</b> and <b>CrNiMo(N)</b> types <b>W.no: 1.4583 X102CrNiMoNb 18 12 316Cb 1.4404, X2CrNiMo 17 12 2, (TP) 316L 1.4401, X4CrNiMo 17 12 2, (TP) 316 1.4571 X6CrNiMo 17 12 2 316 Ti, 1.4580, X6CrNiMoNb 17 12 3, 316Cb 1.4581 G-X5CrNiMoNb 19 11 2, 1.4437 G-X6CrNiMo 18 12, 1.4406, X2CrNiMoN 17 12 3, (TP)316LN</b>
CEWELD AA 347H	9606-1: FM5 Sect IX QW-432: F-No. 6 17633-A: T 19 9 Nb P C1/M21 2 A 5.22: E 347T1-1 E 347T1-4	T > 550 MPa Y > 350 MPa E > 25% I ~ 80J (20°C)	C < 0,08 Mn < 2,0 Si < 1,2 Cr 18 - 21 Ni 9 - 11 Mo < 0,3 Nb+Ta 8xC < 1,1 Cu 0,5	<b>AA 347H</b> is a <b>rutile flux cored wire</b> with <b>fast freezing</b> slag for welding stainless austenitic steels that are exposed to working temperatures up to <b>400 °C</b> . The weld deposit is scale-resistant up to approx. <b>800 °C</b> in normal atmosphere and oxidizing gases. The weld deposit is capable of taking a high polish. Structure: Austenite with delta ferrite. <b>AA 347H</b> offers higher productivity, higher deposition rate and improved wetting properties compared to solid wires. <b>W.no:1.4541,1.4550,1.4552,1.4319,1.4306,1.4306</b>



TYPE	EN -ISO and ASME -AWS	MECHANICAL PROPERTIES	ANALYSIS	APPLICATION
------	-----------------------	-----------------------	----------	-------------

12. CORED WIRE FOR STAINLESS STEEL (DUPLEX STEEL)				
CEWELD AA 2101 (Lean Duplex)	9606-1: FM5 Sect IX QW-432: F-No. 6 17633-A: T 23 7 N L P C1/M21 2 A 5.22: ~E 2307 T1-1 ~E 2307 T1-4	T > 570 MPa Y > 450 MPa E > 20% I ~ 50J (20°C)	C < 0,04 Mn 0,4 - 1,5 Si < 1,0 Cr 22,5 - 25,5 Ni 6,5 - 10 Mo < 0,8 Cu < 0,5 N 0,1 - 0,2	<b>AA 2101 Lean Duplex</b> is a <b>rutile flux cored wire</b> that offers excellent welding properties and is developed especially for <b>Lean Duplex steel</b> . Due to the <b>higher Mn and N</b> content of the Lean duplex base material, the slag viscosity and therefore the flow behavior is changing and the welding bead is liquid for a longer time. The result is a very smooth seam. <b>W.no.: 1.4164, ASTM 32101, LDX2101</b>
CEWELD AA 2209	9606-1: FM5 Sect IX QW-432: F-No. 6 17633-A: T 22 9 3 N L R M21 3 A 5.22: E 2209 T0-4	T > 550 MPa Y > 450 MPa E > 20% I ~ 40J (-60°C)	C < 0,04 Mn < 2,5 Si < 1,2 Cr 21 - 24 Ni 7,5 - 10,5 Mo 2,5 - 4,0 Cu < 0,5 N 0,08 - 0,2	<b>AA 2209</b> is a <b>rutile flux cored wire</b> for welding <b>Duplex stainless steels</b> in chemical industry. Wire shows smooth drop transfer and stable arc with no spatter losses. Ductile weld metal quality and X-ray soundness with easy slag removal and <b>ferrite number 30-50 (FN)</b> . Excellent against pitting and stress corrosion. PREN above 35 weld metal offers outstanding resistance against pitting. <b>W.no.: 1.4162, 1.4462, X2CrNiMoN 22 5 3, 1.4362, X2CrNiN 23 4, 1.4463, 1.4460, 1.4583</b>
CEWELD AA 2209P	9606-1: FM5 Sect IX QW-432: F-No. 6 17633-A: T 22 9 3 N L P M21 1 A 5.22: E 2209 T1-4	T > 550 MPa Y > 450 MPa E > 20% I ~ 40J (-60 °C)	C < 0,04 Mn < 2,5 Si < 1,2 Cr 21 - 24 Ni 7,5 - 10,5 Mo 2,5 - 4,0 Cu < 0,5 N 0,08 - 0,2	<b>AA 2209P</b> is a <b>rutile flux cored wire</b> with fast freezing slag for positional welding of <b>Duplex stainless steels</b> in chemical industry. Wire shows smooth drop transfer and stable arc with no spatter losses. High productivity and excellent weldability, better wetting properties compared to solid wires. PREN above 35 weld metal offers outstanding resistance against pitting. <b>W.no.: 1.4162, 1.4462, X2CrNiMoN 22 5 3, 1.4362, X2CrNiN 23 4, 1.4463, 1.4460, 1.4583</b>
CEWELD AA 2209Pi	9606-1: FM5 Sect IX QW-432: F-No. 6 17633-A: T 22 9 3 N L R M21 1 A 5.22: E 2209 T1-4	T > 700 MPa Y > 600 MPa E > 28% I ~ 70J (-60 °C)	C < 0,04 Mn 0,5 - 2,0 Si < 1,0 Cr 21 - 24 Ni 7,5 - 10 Mo 2,5 - 4,0 N 0,08 - 0,2	<b>AA 2209Pi</b> is a <b>rutile flux cored wire</b> for welding Duplex stainless steels in chemical industry. Excellent for use in <b>position and down hand welding with improved impact properties</b> . Ductile weld metal quality and X-ray soundness with easy slag removal and ferrite level between 30 and 50 (FN). Excellent for use in position and down hand welding. Excellent against pitting and stress corrosion. PREN above 35 weld metal offers outstanding resistance against pitting. <b>W.no.: 1.4162, 1.4462, X2CrNiMoN 22 5 3, 1.4362, X2CrNiN 23 4, 1.4463, 1.4460, 1.4583</b>
CEWELD AA 2594	9606-1: FM5 Sect IX QW-432: F-No. 6 17633-A: T 25 9 4 N L P C1/M21 1 A 5.22: ~E 2594 T1-1 ~E 2594 T1-4	T > 620 MPa Y > 550 MPa E > 18% I ~ 50J (-20 °C) I ~ 25J (-85 °C)	C < 0,04 Mn < 2,5 Si < 1,2 Cr 24 - 27 Ni 8,0 - 10,5 Mo 2,5 - 4,5 N 0,2 - 0,3	<b>AA 2594</b> is a <b>rutile flux cored wire</b> with fast freezing slag intended for welding <b>25Cr type duplex stainless steels</b> especially for <b>Super Duplex</b> grade, <b>PREN &gt;40</b> . Weldable in all positions, high productivity, better wetting properties compared to solid wires. Excellent weld metal quality and X-ray soundness. Applicable for welding: <b>duplex type 2205, 1.4460, 1.4462, 1.4463, 1.4515, 1.4517, 1.4507 URANUS 52N, SAF 25.07, GX 3 CrNiMoCuN 26-6-3, (1.4515), GX 3 CrNiMoCuN 26-6-3-3, (1.4517), 25% Cr Super Duplex steels SAF 25/07, S32750 1.4410 - 25Cr-7Ni-4Mo-0.28N SAF2507, NAS74N, S32760 1.4501 - 25Cr-7Ni-3.8Mo-0.7Cu-0.7W-0.25N, S32506 - SUS329J4L 25Cr-7Ni-3Mo-0.15N-0.2W NAS64, 1.4507, S31803, S32205.</b>
CEWELD AA 2594M	9606-1: FM5 Sect IX QW-432: F-No. 6 17633-A: T 25 9 4 Cu N L M M12 1 A 5.22: E2594 T1-4	T > 620 MPa Y > 550 MPa E > 18% I ~ 35J (-45 °C)	C < 0,04 Mn < 2,5 Si < 1,2 Cr 24 - 27 Ni 8,0 - 10,5 Mo 2,5 - 4,5 Cu 1,0-2,5 N 0,2 - 0,3	<b>AA 2594M</b> is a <b>metal cored wire</b> designed for welding <b>25Cr type duplex stainless steels</b> especially for Super Duplex grade. Excellent productivity, improved weldability, better wetting properties compared to solid wires. Excellent weld metal quality and X-ray soundness. <b>AA 2594M</b> is used for welding <b>duplex type 2205, 1.4460, 1.4462, 1.4463, 1.4515, 1.4517, 1.4507 URANUS 52N, SAF 25.07, GX 3 CrNiMoCuN 26-6-3, (1.4515), GX 3 CrNiMoCuN 26-6-3-3, (1.4517), 25% Cr Super Duplex steels SAF 25/07, S32750 1.4410 - 25Cr-7Ni-4Mo-0.28N SAF2507, NAS74N, S32760 1.4501 - 25Cr-7Ni-3.8Mo-0.7Cu-0.7W-0.25N, S32506 - SUS329J4L 25Cr-7Ni-3Mo-0.15N-0.2W NAS64 1.4507, S31803, S32205</b>
CEWELD AA 904L	9606-1: FM5 Sect IX QW-432: F-No. 6 17633-A: T 20 25 5 Cu N L P M21 2 A 5.22: ~E 385L T0-4	T > 510 MPa Y > 320 MPa E > 25% I ~ 61J (-195 °C)	C < 0,03 Mn 1,0 - 4,0 Si < 1,0 Cr 19 - 22 Ni 24 - 27 Mo 4,0 - 6,0 Cu 1,0 - 2,0 N 0,1 - 0,2	<b>AA 904L</b> is a <b>rutile flux cored wire</b> used for welding steels with similar chemical composition which are used for fabrication of equipment and vessels for handling of sulfuric acid and many chloride containing media. This <b>flux cored wire</b> may also find applications for joining Type 317L material where <b>improved corrosion</b> resistance in specific media is needed. In order to reduce the propensity for fissuring and hot cracking, the low melting elements such as carbon, silicon, and phosphorus are controlled to lower levels in this alloy. <b>W.no.: 1.4500, 1.4505, 1.4506, 1.4531, 1.4536, 1.4539, 1.4573, 1.4585, 1.4586, 4 NS N 08904 1.4539, 1.4537, 1.4519, 1.4505, UNS N08904, S31726, X1NiCrMoCu 25-20-5, X1CrNiMoCuN 25-25-5, X4NiCrMoCuNb 20-18-2, Uranus B6</b>

## CORED WIRE

TYPE	EN -ISO and ASME -AWS	MECHANICAL PROPERTIES	ANALYSIS	APPLICATION
<b>13. CORED WIRE FOR NICKEL BASED ALLOYS</b>				
<b>CEWELD AA C-276</b>	<b>9606-1: FM6</b> <b>Sect IX QW-432: F-No. 43</b> <b>12153-A:</b> T Ni 6276 P M21 2 (NiCr15Mo15Fe6W4) <b>A 5.34:</b> ENiCrMo4 T1-4	T > 690 MPa Y > 400 MPa E > 25% I ~ 90J (-20 °C) I ~ 60J (-196 °C)	C < 0,02 Mn < 1,0 Fe 4,0 - 7,0 Si < 0,2 Cu < 0,5 Ni Rest Co < 2,5 Cr 14,5 - 16,5 Mo 15 - 17 V 0,35 W 3,0 - 4,5	<b>AA C-276</b> is a <b>rutile flux cored wire</b> and used for welding materials of similar composition. This <b>low carbon nickel-chromium-molybdenum</b> filler metal can also be used for dissimilar welding between nickel base alloys and super austenitic stainless steels, as well as for surfacing and cladding on low alloyed steels. <b>Hasteloy C276, NiCrMo alloys.</b>
<b>CEWELD AA NiCro 600</b>	<b>9606-1: FM6</b> <b>Sect IX QW-432: F-No. 43</b> <b>12153-A:</b> T Ni 6182 R M21 3 (NiCr15Fe6Mn) <b>A 5.34:</b> ENiCr3 T0-4	T > 550 MPa Y > 360 MPa E > 25% I ~ 128J (-0 °C) I 60J (-196 °C)	C < 0,1 Mn 5,0 - 9,5 Fe < 10,0 Si < 1,0 Cu < 0,5 Ni > 59 Co < 0,1 Ti < 1,0 Cr 13 - 17 Nb+Ta 1,0 - 2,5	<b>AA NiCro 600</b> is a <b>rutile flux cored wire</b> developed for welding and cladding <b>nickel-based alloys such as alloy 600</b> or similar materials. This alloy can also be used for welding dissimilar nickel-based alloys to each other, to alloyed steels or to stainless steels. <b>AA NiCro 600</b> can also be used on <b>difficult to weld steels</b> . Applicable for: <b>Incoloy 800, Inconel 600, 601, K 81340, N06600, N06601, N08800, N08810, X8Ni9, 12Ni19, 10Ni 14, NiCr15Fe, NiCr23Fe, X10NiCrAlTi3220, X10CrNi-MoNb18.12, NiCr20Ti.</b> <b>W.no.: 1.5662, 1.5680, 1.5637, 1.4876, 1.4583, 2.4816, 2.4851, 2.4951, 2.4806, Alloy 82, 1.4816, 600L, 800H.</b>
<b>CEWELD AA NiCro 600B</b>	<b>9606-1: FM6</b> <b>Sect IX QW-432: F-No. 43</b> <b>12153-A:</b> T Ni 6182 B M21 3 (NiCr15Fe6Mn) <b>A 5.34:</b> ENiCr3 T0-4	T > 550 MPa Y > 360 MPa E > 25% I ~ 90J (-196 °C)	C < 0,1 Mn 5,0 - 9,5 Fe < 10,0 Si < 1,0 Cu < 0,5 Ni > 59 Co < 0,1 Ti < 1,0 Cr 13 - 17 Nb+Ta 1,0 - 2,5	<b>AA NiCro 600B</b> is a <b>basic flux cored wire</b> developed for welding and cladding <b>nickel-based alloys such as alloy 600</b> or similar materials. This alloy can also be used for welding dissimilar nickel-based alloys to each other, to alloyed steels or to stainless steels. <b>AA NiCro 600B</b> can also be used on <b>difficult to weld steels</b> . Applicable for: <b>Incoloy 800, Inconel 600, 601, K 81340, N06600, N06601, N08800, N08810, X8Ni9, 12Ni19, 10Ni 14, NiCr15Fe, NiCr23Fe, X10NiCrAlTi3220, X10CrNi-MoNb18.12, NiCr20Ti.</b> <b>W.no.: 1.5662, 1.5680, 1.5637, 1.4876, 1.4583, 2.4816, 2.4851, 2.4951, 2.4806, Alloy 82, 1.4816, 600L, 800H.</b>
<b>CEWELD AA NiCro 625</b>	<b>9606-1: FM6</b> <b>Sect IX QW-432: F-No. 43</b> <b>12153-A:</b> T Ni 6625 P M21 2 (NiCr22Mo9Nb) <b>A 5.34:</b> E NiCrMo3 T1-4	T > 690 MPa Y > 420 MPa E > 25% I ~ 110J (20 °C) I ~ 60J (-196 °C)	C < 0,1 Mn < 0,5 Fe < 5,0 Si < 0,5 Cu < 0,5 Ni > 58 Co < 0,1 Ti < 0,40 Cr 20 - 23 Nb+Ta 3,15 - 4,15 Mo 8,0 - 10	<b>AA NiCro 625</b> is a <b>rutile flux cored wire</b> developed for welding and cladding nickel-based alloys such as Inconel 625 or similar materials. This alloy can also be used for welding dissimilar nickel-based alloys to each other, to alloyed steels, to stainless steels and for joining <b>9% Nickel steels</b> . <b>X10NiCrAlTi, 32-20H, 32-21, X8 Ni9, ASTM A 533 Gr1, 800H, Sanicro 28, 254SMo, Inconel 625, UNS : N08926, N08825, N06625, N08020. DIN : X8Ni9, X1NiCrM-oCuN25 20 6, X1NiCrMoCuN25 20 5, NiCr21Mo, NiCr22Mo9Nb</b> <b>W.no.: 1.4876, 1.5656, 1.4529, 2.4858, 2.4856, 1.4539, 1.4547, 2.4660</b>
<b>CEWELD AA NiCro 625B</b>	<b>9606-1: FM6</b> <b>Sect IX QW-432: F-No. 43</b> <b>12153-A:</b> T Ni 6625 B M21 3 <b>A 5.34:</b> E NiCrMo3 T0-4	T > 690 MPa Y > 420 MPa E > 25% I ~ 110J (20 °C) I ~ 70J (-196 °C)	C < 0,1 Mn < 0,5 Fe < 5,0 Si < 0,5 Cu < 0,5 Ni > 58 Co < 0,1 Cr 20 - 23 Nb+Ta 3,15 - 4,15 Mo 8,0 - 10	<b>AA NiCro 625 B</b> is a <b>basic flux-cored wire</b> developed for welding and cladding nickel-based alloys such as Inconel 625 or similar materials. This alloy can also be used for welding dissimilar nickel-based alloys to each other, to alloyed steels, to stainless steels and for joining <b>9% Nickel steels</b> . <b>X10NiCrAlTi, 32-20H, 32-21, X8 Ni9, ASTM A 533 Gr1, 800H, Sanicro 28, 254SMo, Inconel 625, UNS : N08926, N08825, N06625, N08020. DIN : X8Ni9, X1NiCrM-oCuN25 20 6, X1NiCrMoCuN25 20 5, NiCr21Mo, NiCr22Mo9Nb</b> <b>W.no.: 1.4876, 1.5656, 1.4529, 2.4858, 2.4856, 1.4539, 1.4547, 2.4660</b>

TYPE	EN -ISO and ASME -AWS	MECHANICAL PROPERTIES	ANALYSIS	APPLICATION
------	-----------------------	-----------------------	----------	-------------

## 14. CORED WIRE ON STELLITE BASED (COBALT BASED ALLOYS)

CEWELD AA DUR 1	<b>Sect IX QW-432:</b> F-No. 71 <b>14700:</b> T Co2-55-CGTZ (DIN 8555 MSG 20-GF-55-CTZ ) <b>A 5.21:</b> ERC CoCr-C UNS W73031	HRC 52-57	C ~ 2,4 Mn ~ 0,1 Co Rest Fe < 2,5 Si ~ 0,7 Cr ~ 29 W ~ 11	<b>AA DUR 1</b> deposits a <b>cobalt-base</b> alloy with an <b>Austenitic-Ledeburitic structure</b> . This is the hardest of the standard cobalt-base alloys. It has a <b>high resistance to corrosion (especially to reducing acids and impact)</b> , extreme wear and temperature shocks. The alloy is only machinable by grinding. <b>Best used on wear pads, rotary seal rings, pump sleeves and centerless grinder work rests.</b>
CEWELD AA DUR 6	<b>Sect IX QW-432:</b> F-No. 71 <b>14700:</b> T Co2-45-CTZ (DIN 8555 MSG 20-GF-45-CTZ) <b>A 5.21:</b> ERC CoCr-A UNS W73036	HRC 42-47	C ~ 1,0 Mn ~ 0,6 Co Rest Fe < 2,5 Si ~ 1,0 Cr ~ 28 W ~ 4,5	<b>AA DUR 6</b> offers outstanding properties against abrasion, thermo-shock and corrosion combined with high temperatures. The weld deposit can be machined with tungsten-carbide tool tips and by grinding. The hardness of the weld deposit will <b>decrease 16% at 300 °C and about 30% at 600 °C</b> . Excellent alloy <b>against thermal shock</b> , abrasion, erosion, corrosion and cavitation at high temperatures.
CEWELD AA DUR 12	<b>Sect IX QW-432:</b> F-No. 71 <b>14700:</b> T Co2-50-CTZ (DIN 8555 MSG 20-GF-50-CTZ ) <b>A 5.21:</b> ERCCoCr-B UNS W73042	HRC 47-52	C ~ 1,4 Mn ~ 0,1 Co Rest Fe < 2,5 Si ~ 0,8 Cr ~ 29 W ~ 8,0	<b>AA DUR 12</b> offers outstanding resistance against abrasion, <b>thermo-shock and corrosion combined</b> with high temperatures. The weld deposit can be machined with tungsten-carbide tool tips and by grinding. The hardness of the weld deposit will <b>decrease 20% at 600 °C</b> and has a <b>nominal hardness of 47-52 HRC</b> at room temperature. The weld deposit is <b>high heat resistant up to 900 °C</b> . <b>AA DUR 12</b> offers a low coefficient of friction and exceptional resistance to galling. It has cavitation-erosion resistance ten times that of 304 stainless steel, <b>AA DUR 12</b> can be used to protect bearing surfaces in no lubricating conditions due to its resistance to metal-to-metal wear.
CEWELD AA DUR 21	<b>Sect IX QW-432:</b> F-No. 71 <b>14700:</b> T Co1-350-CKTZ (DIN 8555 MSG 20-GF-350-CTZ ) <b>A 5.21:</b> ERC CoCr-E UNS W73041	HB 325-375  <b>Strain hardening</b> HRC 45	C ~ 0,25 Mn ~ 0,3 Ni ~2,5 Co Rest Fe < 2,5 Si ~ 0,8 Cr ~ 27 Mo ~ 5,5	<b>AA DUR 21</b> offers <b>excellent gliding properties</b> against metal to metal wear due to a low coefficient of friction, Excellent <b>against erosion and corrosion</b> at high working temperatures <b>up to 900 °C</b> . <b>Crack free hard facing</b> deposit against severe shock and impact.

## 15. CORED WIRE FOR CAST IRON

CEWELD AA FeNi	<b>9606:</b> (ISO 15608 W71-76) <b>1071:</b> T C Z NiFe-1 M (~DIN 8555 MF NiFe-2)	HB 160 - 190 T 500-600 MPa Y > 340 MPa E ~ 16%	C < 2,0 Si < 4,0 Mn < 2,5 Fe Rest Ni 45 - 75 Cu < 4,0 Al < 1,0	<b>AAFeNi</b> is intended for <b>joining and rebuilding</b> Cast Iron with globular graphite, tempered Cast Iron and for joining Cast Iron with steel, Grey cast iron, malleable, nodular : <b>NF A 32-101 : FGL 150, 200, 250, 300, 350, 400. NF A 32-201 : FGS 370-17, 400-12, 500-7, 600-3, 700-2. NF A 32-702 : MN 350-10, 380-18, 450-6, 350-4, 650-3. DIN 1691: CG-14, 18, 25, 30. DIN 1693 : GGG-40, 50, 60, 70. DIN 1692 : GTS-35, 45, 55, 65, 70, X120Mn12, 1.3401</b>
-------------------	--	---	--	---

## 16. FOR HARDFACING, SHOCK AND ABRASION RESISTANT AFTER STRAIN HARDENING (AUSTENITIC)

CEWELD OA MnCr	<b>14700:</b> T Fe 9 (DIN 8555 MF 7-250-KNP)	HB 220-250  <b>Strain hardening</b> ~ HB 500	C ~ 0,45 Si ~ 0,4 Mn ~15,7 Cr ~ 14,8 Ni ~ 1,25 Mo ~ 0,55 V ~ 0,25 Fe Rest	<b>OA MnCr</b> is a <b>flux cored wire</b> weldable without shielding gas. Applications are: <b>re-building and buffer layers</b> before hardfacing with extreme resistance to heavy impact loads. Rebuilding heavy steel parts, buffer layers, rails, rails crossings, dredger teeth, blast furnace mantles etc. <b>Austenitic deposit with strain hardening properties</b> and no limits in the number of layers. The deposit is <b>non magnetic and can not be flame cut</b> .
CEWELD OA Mn14	<b>14700:</b> T Fe 9 (DIN 8555 MF 7-200-KNP )	HB 200-230  <b>Strain hardening</b> ~HB 450	C ~ 1,0 Si ~ 0,4 Mn ~ 13,7 Cr ~ 4,0 Ni ~ 0,55 Fe Rest	<b>OA Mn14</b> is a <b>flux cored wire</b> weldable without shielding gas. Applications are: <b>re-building</b> and hardfacing of high manganese steels. Very good resistance against high impact. Austenitic deposit with strain hardening properties and no limits in the number of layers. The deposit is <b>non magnetic and can not be flame cut</b> .

## 17. FOR HARDFACING, SHOCK AND ABRASION RESISTANT

CEWELD OA 350	<b>14700:</b> T Fe 3 (DIN 8555 MF 1-350-ST)	HB 325-375	C ~ 0,12 Si ~ 0,5 Mn ~ 1,5 Cr ~ 1,2 Mo ~ 0,4 Ni ~ 2,4	<b>OA 350</b> is a <b>flux cored wire</b> weldable without shielding gas. Weld deposit shows a hardness of 325-375 HB. Hardfacing and rebuilding alloy for worn-out wheels, rails, tracks, tires, conveyors, crossings, buffer layers prior to Hardfacing. Excellent wear and abrasion resistance <b>against heavy impact and shock</b> , good machinable with carbide tools.
CEWELD OA 400	<b>14700:</b> ZT Fe 1 (DIN 8555 MF 3-400-ST)	HB 390-420	C ~ 0,15 Si ~ 0,4 Mn ~ 1,5 Cr ~ 2,0 Mo ~ 3,2 V ~ 0,4	<b>OA 400</b> is a <b>flux cored wire</b> weldable without shielding gas. The weld deposit offers <b>390-420 HB</b> . Rebuilding and hardfacing alloy for <b>extreme critical applications</b> where extreme impact loads and surface pressure causes <b>deformation and cracks</b> .

## CORED WIRE

TYPE	EN -ISO and ASME -AWS	MECHANICAL PROPERTIES	ANALYSIS	APPLICATION
CEWELD AA M37-42	14700: T Z Fe 2 (DIN 8555 MF 1 GF-40 GPS)	HB 380-450 HRc 37-42	C ~ 0,4 Si ~ 0,7 Mn ~ 1,5 Cr ~ 2,5 Mo ~ 0,5 Fe Rest	<b>AA M37-42</b> is a <b>seamless flux cored wire</b> weldable with a M12-M13 or M21 shielding gas. All weld metal offers <b>380-450 HB</b> , rebuilding and hardfacing alloy of forged or rolled mechanical components like: transmission shafts, rolls or chocks for steel making, roller bearing seats, rollers for gantry cranes, gear teeth, forging tools and dies.
2 CEWELD OA 550-VW	14700: T Fe 6 (DIN 8555 MF 6-60-PT )	HRc 54-58	C ~ 0,55 Si ~ 0,9 Mn ~ 2,8 Cr ~ 7,0 Mo ~ 1,6 W ~ 0,9 V ~ 1,8 Fe Rest	<b>OA 550-VW</b> is a <b>flux cored wire</b> weldable without shielding gas. The weld deposit shows very good abrasion resistance in combination with impact even at higher temperatures <b>up to 550 °C</b> . <b>Too much layers should be avoided, preheat is necessary to avoid cracking</b> . A buffer layer with OA 4370 or OA MnCr is recommended in case of sensible base material or old layers.
CEWELD AA M57-62	14700: T Fe 2 (DIN 8555 MSG 6-GF-60 P)	HB 55-62	C ~ 0,5 Si ~ 0,6 Mn ~ 1,5 Cr ~ 6,0 Mo ~ 0,9	<b>AA M57-62</b> is a seamless <b>flux cored wire</b> weldable with M21 shielding gas. The weld deposit offers <b>high resistance to cracking</b> and excellent toughness, all weld metal requires no buffer layer except on materials considered critical. In this situation <b>AA M690</b> is recommended. Suitable for wear parts subject to heavy impact and shock. <b>The weld metal is machinable</b> by special carbide tools, hardening is possible. The maximum hardness is dependent on the base metal and is usually achieved after 3 layers.
<b>18. FOR HARDFACING, HIGH ABRASION RESISTANT</b>				
CEWELD OA 54 L	14700: ~T Fe14 (DIN 8555 MF 10-55-CGT)	HRc 55-58	C ~ 3,7 Si ~ 1,2 Mn ~ 0,2 Cr ~ 32	<b>OA 54 L</b> is a <b>flux cored wire</b> weldable without shielding gas, based on a C-Cr carbide deposit for abrasive wear resistance in combination with corrosion. Can be welded crack free by preheating approximately <b>450 °C</b> and slow cooling down. Main application includes: wear plates, dredging buckets and other components exposed to heavy wear.
CEWELD OA 55 TC	14700: T Fe8 (DIN 8555 MF 6-55-GP)	HRc 55-59	C ~ 1,7 Si ~ 1,4 Mn ~ 1,0 Cr ~ 7,2 Mo ~ 1,3 Ti ~ 5,0 Fe Rest	<b>OA 55 TC</b> is a <b>flux cored wire</b> based on a C-Cr-Mo-Ti deposit. Weldable without shielding gas. Very good wear resistance against abrasion combined with impact. The deposit gives already a very good hardness in the second layer thanks to the Titanium carbides. The choice for the buffer layer is depending on the base metal and not always necessary. Main applications includes: crusher rollers, hammers, gravel pumps, bucket collars etc.
CEWELD OA 56 Nb	14700: T Fe8 (DIN 8555 MF 6-60-GP)	HRc 55-60	C ~ 1,4 Si ~ 0,7 Mn ~ 1,3 Cr 5,0 - 7,0 Mo 1,0 - 1,5 Nb ~ 8,0 V ~ 1,0 W ~ 1,2	<b>OA 56 Nb</b> is a <b>flux cored wire</b> weldable without shielding gas. The Cr-Nb based deposit offers excellent impact pressure strength combined with aggressive mineral wear. The choice for the buffer layer is depending on the base metal and not always necessary. Main applications: cement rollers, crushers, mineral- and brick crushing, screw conveyors, garbage recycling etc.

TYPE	EN -ISO and ASME -AWS	MECHANICAL PROPERTIES	ANALYSIS	APPLICATION
------	-----------------------	-----------------------	----------	-------------

19. FOR HARDFACING, EXTREME WEAR RESISTANT				
CEWELD OA 612	14700: T Fe8 (DIN 8555 MF 6-GF-55-RP)	HRc 54-57	C ~ 0,5 Si ~ 1,0 Mn ~ 1,2 Cr 12 - 13	OA 612 is a high alloyed <b>flux cored wire</b> for hardfacing, weldable without shielding gas. The weld deposit offers very good <b>resistance against general abrasion and heavy shock</b> , all weld metal requires no buffer layer except on materials considered critical or in case of old hardfacing layers
CEWELD OA 57-62 Nb	14700: T Fe8 (DIN 8555 MF 6-GF-60-GP)	HRc 57-62	C ~ 1,3 Si ~ 1,4 Mn ~ 0,8 Cr 5,0 - 7,0 Nb ~ 6,5 Fe Rest	OA 57-62 Nb is a <b>Niobium -alloyed seamless flux cored wire</b> for hardfacing under M21 or without shielding gas. Due to the high <b>Niobium content this alloy offers very good resistance against abrasion</b> by minerals, all weld metal requires no buffer layer except on materials considered critical or old hard surfacing layers. Weld metal is only machinable by grinding.
CEWELD OA 58	14700: T Fe15 (DIN 8555 MF 10-60-G)	HRc 57-62	C ~ 4,6 Si ~ 1,5 Mn ~ 0,2 Cr ~ 29 Mo ~ 1,3 Fe Rest	OA 58 is a high alloyed <b>flux cored wire</b> for hardfacing. Weldable without shielding gas. The weld deposit offers <b>very good resistance against heavy abrasion wear</b> caused by minerals. Due to the addition of Mo in the weld metal the deposit can resist temperatures up to <b>450°C</b> . Maximum thickness of overlay welding is 2-3 layers (8-10mm), whereby the weld metal has less resistance to impact.
CEWELD OA 59	14700: T Fe15 (DIN 8555 MF 10-GF-60-G)	HRc 57-62	C ~ 5,0 Si ~ 1,0 Mn ~ 0,4 Cr ~ 22,5 Nb ~ 7,0 Fe Rest	OA 59 is a <b>C-Cr-Nb -alloyed flux cored wire</b> for hardfacing. Weldable without shielding gas. Due to the <b>high Cr- and Nb carbide content this alloy offers extreme resistance against abrasion by minerals</b> , suitable for low to medium impact. Maximum thickness of overlay welding is 2-3 layers (8-10mm). No buffer layer required except on materials considered critical or old hardfacing layers. Applications include: <b>cement crusher rolls, dredger pumps, dredger buckets, coke hammers, Nihard wear parts etc.</b>
CEWELD OA 59 H	14700: T Fe15 (DIN 8555 MF 10-GF-65-G)	HRc 59-65	C ~ 5,3 Si ~ 1,3 Mn ~ 0,4 Cr ~ 22 Nb ~ 7,0 B ~ 1,0 Fe Rest	OA 59H is <b>C-Cr-Nb-B carbide based flux cored wire</b> for hardfacing. Weldable without shielding gas. Extreme abrasion resistance with low to medium impact and working temperature up to <b>450°C</b> . Maximum of 2 layers is recommended. Applications include: <b>mixing blades, cement pumps, screw conveyors, dredging buckets, wear plates etc.</b>
CEWELD OA 60-68B	14700: T Fe13 (DIN 8555 MF 4-GF-65-G)	HRc 60-68	C ~ 0,5 Si ~ 0,3 Mn ~ 1,1 Cr ~ 0,3 Mo ~ 1,5 B ~ 4,8 Fe Rest	OA 60-68B is a <b>seamless flux cored Cr free wire</b> for hardfacing. Weldable with M21 or without shielding gas. Due to the <b>high B content this alloy offers very good resistance against abrasion by sand and minerals</b> . The weld metal shows an excellent hardness with just 1 layer. Applications include: <b>mining- and agricultural equipment, snow scrapers, mixing paddles, etc.</b>
CEWELD OA 60-70B	14700: T Z Fe13 (DIN 8555 MF 10-GF-70-G)	HRc > 67	C ~ 1,8 Si ~ 0,6 Mn ~ 0,8 Cr ~ 8,1 B ~ 4,2 Ni ~ 1,5 Fe Rest	OA 67-70B is a Cr-B -alloyed <b>seamless flux cored wire</b> for hardfacing. Weldable with M21 or without shielding gas. Due to the high <b>Cr-B content this alloy offers very good resistance against abrasion by sand and minerals</b> . Maximum of 2 layers is recommended. Weld metal can only be machined by grinding. Cracks that occur after welding on the surface do not effect the wear resistance. Applications include: <b>cement pumps, conveyor chains, mining- and agricultural equipment, etc.</b>
CEWELD MA 600 (1.4718)	14700: T Fe 8 (DIN 8555 MF 6-GF-60-G)	HRc 57-62	C ~ 0,45 Si ~ 2,9 Mn ~ 0,5 Cr ~ 9,0 Mo ~ 0,5 Fe Rest	<b>MA 600 (1.4718)</b> is 9% Cr based hardfacing alloy with excellent weldability with M20/21 shielding gas. Suitable for hardfacing applications on components that are subject to wear and heavy impact. No buffer layer necessary except on materials considered critical or old hard surfacing layers. Weld metal can only be machined by grinding. <b>MA 600 (1.4718)</b> has proven itself in a wide range of applications in many different industries. Applications include: <b>stone crushers, recycling hammers, cutting knives, dredger components, buckets etc.</b>
CEWELD OA 61	14700: T Fe16 (DIN 8555 MF 10-GF-65-G)	HRc 62-64 bei 20 °C HRc 52-54 bei 400 °C HRc 47-49 bei 600 °C	C ~ 4,0 Si ~ 1,2 Mn ~ 0,8 Cr ~ 22 B ~ 1,1 W ~ 0,7 V ~ 0,8 Fe Rest	OA 61 is <b>C-Cr-B-W-V</b> alloyed <b>flux cored wire</b> for hardfacing. Weldable without shielding gas. Extreme hard Martensitic weld deposit that offers excellent abrasion resistance against sand and minerals with low to medium impact, up to temperatures of <b>600 °C</b> . Applications include: <b>mining, wear plates, stone crushers, cement industry, paddlewheel separators, brick industry etc.</b>
CEWELD OA 62	14700: T Fe15 (DIN 8555 MF 10-70-GRZ)	HRc 66-68 bei 20 °C HRc 62-64 bei 400 °C HRc 52-56 bei 600 °C	C ~ 5,0 Si ~ 0,9 Mn ~ 0,2 Cr ~ 38 B ~ 2,0 Fe Rest	OA 62 is a high alloyed <b>C-Cr-B flux cored wire</b> for hardfacing. Weldable without shielding gas. The weld deposit is Ledeburitic with high content of Cr carbides and Borium. Extreme wear resistance even at higher temperatures. The deposit gives <b>wear resistance in second layer</b> . A buffer layer is recommended in case of critical base material or old layers. Recommended is Ceweld OA MnCr with suitable preheat. Applications include: <b>dredging teeth, spiked crushers, mixer blades, screw conveyors, sintering lines, coke scrapers etc.</b>



## CORED WIRE

TYPE	EN -ISO and ASME -AWS	MECHANICAL PROPERTIES	ANALYSIS	APPLICATION
CEWELD OA 63	14700: T Fe15 (DIN 8555 MF 10-65-G)	HRc 62-65	C ~ 4,7 Si ~ 1,7 Mn ~ 0,2 Cr ~ 22 Nb ~ 7,0 B ~ 1,0 Fe Rest	<b>OA 63</b> is a high alloyed <b>C-Cr-Nb-B flux cored wire</b> for hardfacing. Weldable without shielding gas. Extreme wear resistance against abrasion even at higher temperatures up to 450°C. Because of its high hardness a maximum of 2 layers is recommended. Applications up to medium impact loads. A buffer layer is recommended in case of critical base material or old hardfacing layers. Applications include: <b>mixing blades, cement pumps, screw conveyors, dredging buckets, wear plates etc.</b>
CEWELD OA 63 V	14700: T Fe16 (DIN 8555 MF 10-65-GZ)	HRc 64-67	C ~ 5,0 Si ~ 1,0 Mn ~ 0,2 Cr ~ 22 V ~ 10 Fe Rest	<b>OA 63 V</b> is a high <b>C-Cr-V carbide based flux cored wire</b> for hardfacing. Weldable without shielding gas. Excellent abrasion resistance <b>against aggressive mineral wear</b> . The high V content makes this alloy suitable for higher temperatures. Applications include: <b>mining equipment, cement pumps, screw conveyors, brick crushers, sand – and stone washing equipments etc.</b>
CEWELD OA 63 VWB	14700: ZT Fe15 (DIN 8555 MF 10-GF-65-G)	HRc 62-64	C ~ 5,0 Si ~ 1,1 Mn ~ 0,8 Cr ~ 25 V ~ 6 W ~ 1-3 +B ~ Fe Rest	<b>OA 63 VWB s C-Cr-B-W-V carbide based flux cored wire</b> for hardfacing. Weldable without shielding gas. Extreme abrasion resistant with improved impact properties when combined with <b>OA 400</b> as buffer layer. Due to the combination Cr-V-W-B carbides the deposit structure contains very fine particles that results in excellent wear resistance against heavy abrasion. Usually the maximum number of layers is 2 till 3 but when using a <b>special stringer build up technique with release cracks, up to 15 layers is possible</b> . Applicable include: <b>grinding rollers, grinding scissors</b>
CEWELD OA 64	14700: T Fe16 (DIN 8555 MF 10-65-GZ)	HRc 63-65 at 20 °C HRc 61 at 400 °C HRc < 57 at 650 °C	C ~ 5,0 Si ~ 1,4 Mn ~ 0,15 Cr ~ 21 Mo ~ 6,0 Nb ~ 6,2 V ~ 1,0 W ~ 1,8 Fe Rest	<b>OA 64</b> is high <b>C-, Cr-, Mo-, Nb-, V-, W-alloyed flux cored wire</b> . Weldable without shielding gas. The weld deposit contains extremely hard carbides that offers excellent resistance against heavy abrasive wear caused by minerals, up to temperatures of <b>650 °C</b> . More than 1 or 2 layers should not be deposited. Buffer layer with OA 4370 or OA MnCr is recommended in case of old layers or critical base materials. Applications include: <b>screw conveyors, fire gratings, sintering plants, augers blast furnace bells, mixing paddles, sugar mill knives, cements pumps etc.</b>
CEWELD OA 67 NiB	14700: T Fe13 (DIN 8555 MF 2-GF-70-G)	HRc 64-68	C ~ 0,5 Si ~ 1,2 Mn ~ 1,8 Ni ~ 2,9 B ~ 4,8 +V	<b>OA 67 NiB</b> is a Ni-B alloyed flux cored wire for hardfacing. Weldable without shielding gas. <b>Extreme good wear resistant</b> even with thin coating thickness due to a high amount of boron carbides. A extreme high hardness is <b>already achieved in the first layer</b> . The weld deposit will show <b>release cracks to offer better bonding strength</b> with the base metal. More than 1 layer should not be deposited. A Buffer layer is recommended in case of sensitive base material or old unknown layers. OA 67 NiB can be welded without using shielding gas.
CEWELD OA 68 Nb	14700: T Fe 16 (DIN 8555 MF 10-70-G)	HRc 67-69	C ~ 4,0 Si ~ 1,2 Mn ~ 0,25 Cr ~ 18 Mo ~ 0,3 Nb ~ 11 V ~ 0,45 B ~ 1,8 Fe Rest	<b>OA 68Nb</b> is a high <b>C-Cr-Nb-B-</b> alloyed <b>flux cored wire</b> for hardfacing against extreme abrasive wear by minerals. Weldable without shielding gas. <b>More than 1, maximum 2 layers should not be deposited</b> . Due to high content of Cr– and Nb carbides machining afterwards is not possible.
<b>20. FOR HARDFACING, TUNGSTEN BASED ALLOYS</b>				
CEWELD OA WC2 Ni	14700: T Ni 20 (DIN 8555 MF 21-GF-55-CGTZ)	HRc ~55 (Matrix) HV 2400 (Karbide)	Ni-Cr- B-Si Rest  eingelagerte W-Kar- bide ~ 62	<b>OA WC2 Ni</b> is a <b>Ni–B–Si</b> alloyed <b>flux cored wire</b> for hardfacing. The weld deposit contains a high amount of <b>Tungsten Carbides</b> . Weldable without shielding gas. This alloy <b>provides an excellent corrosion resistance</b> combined with extreme abrasion resistance. <b>OA WC2 Ni</b> can be applied on all sorts of steels except on cast iron or Mn-steel. This alloy is the most wear resistant type in most hardfacing applications. In case of very fine dust abrasion It might happen that the matrix will be washed out and loses the imbedded Tungsten carbides, in this case another hardfacing product should be considered.
CEWELD OA WC2 Fe	14700: T Fe 20 (DIN 8555 MF 21-GF-65-GZ)	HRc ~66 (Matrix) HV 2400 (Karbide)	Fe Rest  eingelagerte W-Kar- bide ~ 56	<b>OA WC2 Fe</b> is a <b>Iron alloyed flux cored wire</b> for hardfacing. The weld deposit obtains a high amount of <b>Tungsten Carbides</b> . Weldable without shielding gas. This fused tungsten carbide based alloy provides an excellent resistance against extreme abrasion wear. <b>OA WC2-Fe</b> can be applied on most type of steels except on cast iron or Mn-steel. This alloy is the most wear resistant type in almost any hardfacing application.



TYPE	EN -ISO and ASME -AWS	MECHANICAL PROPERTIES	ANALYSIS	APPLICATION
------	-----------------------	-----------------------	----------	-------------

## 21. FOR HARDFACING WITH STAINLESS ALLOY

<b>CEWELD AA 410</b>	<b>ISO 14700:</b> T 13 / T 410 <b>A 5.22:</b> E 410T0-4	300 - 350 HB	C ~0,12 Mn 1,2 Si ~ 0,8 Cr ~13,5 Mo ~0,5	<b>AA 410</b> is a stainless <b>flux cored wire</b> for hardfacing. Overlay of carbon and low-alloy steels for resistance to corrosion, erosion, or abrasion. <b>AA 410</b> has higher hardness and is used in valve seats to obtain better galling resistance. Normally to obtain adequate ductility, preheat and post-weld heat-treatment are required. <b>AA 410</b> is a martensitic stainless steel that is heat-treatable. It has a nominal weld metal composition of 12% Chromium. These weld deposits are air-hardenable that can normally be heat-treated after welding. <b>For welding or repairing 12% Cr air-hardenable stainless steels like types 410, 416, 420, 431 and cast C-15, W.Nr: 1.4008, 1.4000, 1.4006, X8Cr14, X6Cr13, X10Cr13 and cast steels.</b>
<b>CEWELD AA 410 NiMo</b>	<b>ISO 14700:</b> T 13 4 / T 410 NiMo <b>A 5.22:</b> E 410 NiMoT0-4	38 -42 HRc	C < 0,06 Mn < 1,5 Si < 1,0 Cr 11-14,5 Ni 3,0 - 5,0 Mo 0,4 - 1,0 Nb - Cu < 0,5	<b>AA 410NiMo</b> is a Cr-Ni-Mo- alloyed, gas-shielded flux-cored wire electrode for cladding. The corrosion resistant deposit offers a medium hardness and is resistant against metal-metal wear and high surface pressure. He is steel mill rollers, thermoshock resistant and suitable for Francis and Pelton turbines. Used in steam power plants for its excelent resistance to cavitation and stress corrosion cracking. <b>Water and steam turbine parts of the same kind, thermoshock and high heat resistant. 1.4313, 1.4002, (G)X5CrNi(Mo) 13 4, X6CrAl 13, Grade CA 6 NM.</b>
<b>CEWELD OA 410 NiMo</b>	<b>ISO 14700:</b> T 13 4 / T 410 NiMo <b>A 5.22:</b> E 410 NiMoT0-3	38 -41 HRc	C < 0,06 Mn < 1,5 Si < 1,0 Cr 11 - 14,5 Ni 3,0 - 5,0 Mo 0,4 - 1,0 Nb - Cu < 0,5	<b>OA 410NiMo</b> is a Cr-Ni-Mo- alloyed, self-shielded flux-cored wire electrode for cladding. The corrosion resistant deposit offers a medium hardness and is resistant against metal-metal wear and high surface pressure. He is steel mill rollers, thermoshock resistant and suitable for Francis and Pelton turbines. Used in steam power plants for its excelent resistance to cavitation and stress corrosion cracking. <b>Water and steam turbine parts of the same kind, thermoshock and high heat resistant. 1.4313, 1.4002, (G)X5CrNi(Mo) 13 4, X6CrAl 13, Grade CA 6 NM.</b>



# 3 - SOLID WIRES



3

# 3 - SOLID ROD



# SOLID WIRE

No.	Group	Page
0	OVERVIEW OF THE SOLID WIRE	3/3-7
<b>SOLID WIRES FOR JOINING</b>		
1	GMA (MAG) WELDING OF NON-AND LOW-ALLOYED STEEL	3/8
2	GMA (MAG) WELDING OF CREEP RESISTANT STEEL	3/8-9
3	GMA (MAG) WELDING OF WEATHER RESISTANT STEEL	3/9
4	GMA (MAG) WELDING OF FINE GRAIN STEEL	3/9-10
5	GTA (TIG) WELDING OF NON-AND LOW-ALLOYED STEEL	3/10
6	GTA (TIG) WELDING OF CREEP RESISTANT STEEL	3/11
7	GTA (TIG) WELDING OF WEATHER RESISTANT STEEL	3/11
8	GTA (TIG) WELDING OF FINE GRAIN STEEL	3/12
9	OXY-ACETYLENE/OXY-FUEL WELDING OF NON-AND LOW-ALLOYED STEEL	3/12
10	GMAW/GTAW (MIG/MAG/TIG) WELDING OF STAINLESS STEEL	3/13-15
11	GTA (TIG) WIRE RODS FOR WELDING OF STAINLESS STEEL	3/16-18
12	GMAW/GTAW (MIG/TIG) WIRE AND ROD FOR NICKEL BASED ALLOYS	3/18-21
<b>HARDFACING</b>		
13	GTAW (TIG) WIRE AND ROD FOR STELLITE (COBALT ALLOYS)	3/21-22
14	GMAW/GTAW (MIG/MAG/TIG) WIRE AND ROD FOR HARDFACING	3/22-23
15	GMAW/GTAW (MIG/MAG/TIG) STAINLESS WIRE AND ROD FOR HARDFACING	3/23
<b>WIRES FOR SPECIAL APPLICATIONS</b>		
16	GMAW/GTAW (MIG/TIG) WELDING OF ALUMINIUM ALLOYS	3/23-24
17	GMAW/GTAW (MIG/TIG) WELDING OF TITANIUM ALLOYS	3/24
18	TB BRAZING OF COPPER ALLOYS	3/25
19	GMAW/GTAW (MIG/TIG) WELDING OF COPPER ALLOYS	3/25-26

CLICK HERE FOR EXTENDED SEARCH

SEARCH

**Disclaimer:** Whilst all reasonable efforts have been made to ensure the accuracy of the information contained, the information contained or otherwise referenced herein is presented only as "typical" without guarantee or warranty, and any liability incurred from any reliance thereon is expressly disclaimed. Typical data are those obtained when welded and tested in accordance to prescribed standards, and should not be assumed to be the expected results in a particular application or weldment. Other tests and procedures may produce different results. Users are cautioned to confirm by qualification testing, or other appropriate means, the suitability of any welding consumable and procedure before use in the intended application. The selection and use of specific products is solely within the control of, and remains the sole responsibility of the customer. The right to change design and/or specifications without notice is reserved.

Certilas Nederland B.V. | Gloxinialaan 2, 6851 TG Huissen, The Netherlands | [info@certilas.com](mailto:info@certilas.com) | [www.certilas.com](http://www.certilas.com) | Rev.2023.

Overview - **SOLID WIRE**

No.	Product Name	ISO	ASME	FM Group	F-Number:	Page
<b>1. GMA (MAG) WELDING OF NON-AND LOW-ALLOYED STEEL</b>						
1	CEWELD SG 1	14341-A: G 42 2 M21/C1 2Si	A 5.18: ER 70S-3	FM1	F-No. 6	3/8
2	CEWELD SG TITAN	14341-A: G 46 A M21 2Ti	A 5.18: ER 70S-2	FM1	F-No. 6	3/8
3	CEWELD SG 2	14341-A: G 42 3 C1 3Si 1 14341-A: G 42 4 M21 3Si 1	A 5.18: ER 70S-6	FM1	F-No. 6	3/8
4	CEWELD SG 3	14341-A: G 42 4 C1 4Si 1 14341-A: G 46 4 M21 4Si1	A 5.18: ER 70S-6	FM1	F-No. 6	3/8
5	CEWELD SG Mo	14341-A: G 42 2 C1 2Mo 14341-A: G 46 6 M21 2Mo 21952-A: G MoSi	A 5.28: ER 70S-A1 A 5.28: ER 80S-G	FM1 / FM3	F-No. 6	3/8
<b>2. GMA (MAG) WELDING OF CREEP RESISTANT STEEL</b>						
6	CEWELD SG CrMo1	21952-A: G CrMo1Si	A 5.28: ER 80S-G	FM3	F-No. 6	3/8
7	CEWELD ER 80S-B2	21952-B: G 1CM	A 5.28: ER 80S-B2	FM3	F-No. 6	3/8
8	CEWELD SG CrMo2	21952-A: G CrMo2Si	A 5.28: ER 90S-G A 5.28: ER 90S-B3 (mod)	FM3	F-No. 6	3/8
9	CEWELD ER 90S-B3	21952-B: G 62 M 2C1M2 (CrMo2Si)	A 5.28: ER 90S-B3	FM3	F-No. 6	3/8
10	CEWELD SG CrMo5	21952-A: G CrMo5Si	A 5.28: ER 80S-B6	FM4	F-No. 6	3/8
11	CEWELD ER 80S-B8	21952-A: G CrMo9	A 5.28: ER 80S-B8	FM4	F-No. 6	3/9
12	CEWELD ER 90S-B9 (P91)	21952-A: G CrMo91	A 5.28: ~ER 90S-B9	FM4	F-No. 6	3/9
13	CEWELD ER 90S-G (P92)	21952-A: G ZCrMoWVNb9 0,5 1,5	A 5.28: ER 90S-G	FM4	F-No. 6	3/9
<b>3. GMA (MAG) WELDING OF WEATHER RESISTANT STEEL</b>						
14	CEWELD SG Corten	14341-A: G 42 2 M21 Z2NiCu	A 5.18: ER 80S-G	FM1	F-No. 6	3/9
<b>4. GMA (MAG) WELDING OF FINE GRAIN STEEL</b>						
15	CEWELD ER 80S-D2	14341-A: G 50 5 M21 4Mo,	A 5.28: ER 80S-D2	FM1	F-No. 6	3/9
16	CEWELD SG Ni1	14341-A: G 50 6 M21 3Ni1	A 5.28: ER 80S-Ni1	FM1	F-No. 6	3/9
17	CEWELD SG Ni2,5	14341-A: G 46 6 M21 2Ni2	A 5.28: ER 80S-Ni2	FM1	F-No. 6	3/9
18	CEWELD SG NiMo1	14341 B: G 57A 5 M21 SN1	A 5.28: ER 80S-Ni1	FM2	F-No. 6	3/9
19	CEWELD SG3 NiMo1	16834-A: G 62 6 M21 Mn3Ni1Mo	A 5.28: ER 100S-G	FM2	F-No. 6	3/9
20	CEWELD ER 100 S-G(L)	16834-A: G 62 5 M21 Mn3NiCrMo	A 5.28: ER 100S-G	FM2	F-No. 6	3/9
21	CEWELD ER 100 S-G	16834-A: G 69 4 M21 Mn3Ni1CrMo	A 5.28: ER 100S-G, A 5.28: ER 110S-G	FM2	F-No. 6	3/10
22	CEWELD ER 110 Ti	16834-A: G 69 6 M21 Mn4Ni1,5CrMo	A 5.28: ER 110S-G	FM2	F-No. 6	3/10
23	CEWELD ER 110 S-1	16834-A: G 79 5 M Mn4Ni1,5CrMo	A 5.28: ER 110S-1	FM2	F-No. 6	3/10
24	CEWELD ER 120 S-G	16834-A: G 89 6 M21 Mn4Ni2CrMo	A 5.28: ER 120S-G	FM2	F-No. 6	3/10
25	CEWELD ER 120 S-1	16834-A: G 89 5 M Mn4Ni2,5CrMo	A 5.28: ER 120S-G	FM2	F-No. 6	3/10
<b>5. GTA (TIG) WELDING OF NONALLOYED STEEL</b>						
26	CEWELD SG 1 Tig	636-A: W 42 2 2Si	A 5.18: ER 70S-3	FM1	F-No. 6	3/10
27	CEWELD SG TITAN Tig	636-A: W 46 2 2Ti	A 5.18: ER 70S-2	FM1	F-No. 6	3/10
28	CEWELD SG 2 Tig	636-A: W 46 5 3Si1	A 5.18: ER 70S-6	FM1	F-No. 6	3/10
29	CEWELD SG 3 Tig	636-A: W 50 5 4Si1	A 5.18: ER 70S-6	FM1	F-No. 6	3/10
30	CEWELD SG Mo Tig	636-A: W 46 4 2Mo 21952-A: W MoSi	A 5.28: ER 70S-A1	FM1 / FM3	F-No. 6	3/10
<b>6. GTA (TIG) WELDING OF CREEP RESISTANT STEEL</b>						
31	CEWELD SG CrMo1 Tig	21952-A: W CrMo1Si	A 5.28: ER 80S-G	FM3	F-No. 6	3/11
32	CEWELD ER 80S-B2 Tig	21952-B: W1CM	A 5.28: ER 80S-B2	FM3	F-No. 6	3/11
33	CEWELD ER 70S-B2L Tig	21952-B: W1CM	A 5.28: ER 70S-B2L	FM3	F-No. 6	3/11
34	CEWELD SG CrMo2 Tig	21952-A: W CrMo2Si	A 5.28: ER 90S-G A 5.28: ER 90S-B3 (mod)	FM3	F-No. 6	3/11
35	CEWELD ER 90S-B3 Tig	21952-B: W 2C1M	A 5.28: ER 90S-B3	FM3	F-No. 6	3/11
36	CEWELD SG CrMo5 Tig	21952-A: W CrMo5Si	A 5.28: ER 80S B6	FM4	F-No. 6	3/11
37	CEWELD ER 80S-B8 Tig	21952-A: W CrMo9	A 5.28: ER 80S-B8	FM4	F-No. 6	3/11
38	CEWELD ER 90S-B9 (P91) Tig	21952-A: W CrMo91	A 5.28: ER 90S-B9	FM4	F-No. 6	3/11
39	CEWELD ER 90S-G (P92) Tig	21952-A: W ZCrMoWVNb 9 0.5 1.5	A 5.28: ER 90S-G	FM4	F-No. 6	3/11
<b>7. GTA (TIG) WELDING OF WEATHER RESISTANT STEEL</b>						
40	CEWELD SG Corten Tig	636-A: W 42 4 Z2NiCu	A 5.28: ER 80S-G	FM1	F-No. 6	3/11

# SOLID WIRE - Overview

No.	Product Name	ISO	ASME	FM Group	F-Number:	Page
<b>8. GTA (TIG) WELDING OF FINE GRAIN STEEL</b>						
41	CEWELD ER 80S-D2 Tig	21952-A: W 57A 4 W4M31	A 5.28: ER 80S-D2 / ER 90S-D2	FM1	F-No. 6	3/12
42	CEWELD SG Ni1 Tig	21952-A: W 46 6 3Ni1	A 5.28: ER 80S-Ni1	FM1	F-No. 6	3/12
43	CEWELD SG Ni2,5 Tig	636-A: W 42 9 2Ni2	A 5.28: ER 80S-Ni2	FM1	F-No. 6	3/12
44	CEWELD SG CrMoV6 TIG	-	A 5.28: ~ER 90S-G (Air 9117 - 15CDV6)	-	-	3/12
45	CEWELD ER 100 S-G Tig	16834-A: W 69 4 11 Mn3Ni1CrMo	A 5.28: ER 100S-G,	FM2	F-No. 6	3/12
46	CEWELD ER 110 S-1 Tig	16834-A: W 79 4 11 Mn3Ni1CrMo	A 5.28: ER 110S-1	FM2	F-No. 6	3/12
47	CEWELD ER 120 S-1 Tig	16834-A: W 89 5 11 Mn4Ni2CrMo	A 5.28: ER 120S-G	FM2	F-No. 6	3/12
<b>9. OXY-ACETYLENE / OXY-FUEL WELDING OF NON-ALLOYED STEEL</b>						
48	CEWELD G1	20378: O I	A 5.2: R45	FM1	F-No. 6	3/12
49	CEWELD G2	20378: O II	A 5.2: R60	FM1	F-No. 6	3/12
50	CEWELD G3	20378: O III	A 5.2: ~R60	FM1	F-No. 6	3/12
51	CEWELD G4	20378: O IV	A 5.2: ~R60	FM1	F-No. 6	3/12
<b>10. GMA/GTA (MAG/TIG) WELDING OF STAINLESS STEEL</b>						
52	CEWELD 410 NiMo CEWELD 410 NiMo Tig	14343-A: G 13 4 14343-A: W 13 4	A 5.9: ER 410NiMo	FM5	F-No. 6	3/13
53	CEWELD 430 CEWELD 430 Tig	14343-A: G 17 14343-A: W 17	A 5.9: ER 430	FM5	F-No. 6	3/13
54	CEWELD 430LNb	14343-A: G 18 L Nb	A 5.9: ER 430LNb	FM5	F-No. 6	3/13
55	CEWELD 430LNbTi	14343-A: G 17	A 5.9: ER 430Nb (mod)	FM5	F-No. 6	3/13
56	CEWELD 307	14343-A: G 18 8 MnSi	A 5.9: ~ER307	FM5	F-No. 6	3/13
57	CEWELD 308LSi	14343-A: G 19 9 L Si	A 5.9: ER 308LSi	FM5	F-No. 6	3/13
58	CEWELD 308H	14343-A: G 19 9 H	A 5.9: ER 308 / ~ER 308H	FM5	F-No. 6	3/13
59	CEWELD 309LSi	14343-A: G 23 12 L Si	A 5.9: ER 309LSi	FM5	F-No. 6	3/13
60	CEWELD 309H	14343-A: G 22 12 H	A 5.9: ER 309	FM5	F-No. 6	3/13
61	CEWELD 309LMo	14343-A: G 23 12 3 L	A 5.9: ~ER 309LMo	FM5	F-No. 6	3/13
62	CEWELD 310	14343-A: G 25 20	A 5.9: ER 310	FM5	F-No. 6	3/14
63	CEWELD 312	14343-A: G 29 9	A 5.9: ER 312	FM5	F-No. 6	3/14
64	CEWELD 316L	14343-A: G 19 12 3 L	A 5.9: ER 316L	FM5	F-No. 6	3/14
65	CEWELD 316LSi	14343-A: G 19 12 3 LSi	A 5.9: ER 316LSi	FM5	F-No. 6	3/14
66	CEWELD 316H	14343-A: G 19 12 3 H	A 5.9: ER 316H	FM5	F-No. 6	3/14
67	CEWELD 316LMn	14343-A: G 20 16 3 Mn N L	A 5.9: ER 316LMn	FM5	F-No. 6	3/14
68	CEWELD 317L	14343-A: G 18 15 3 L	A 5.9: ER 317L	FM5	F-No. 6	3/14
69	CEWELD 318Si	14343-A: G 19 12 3 Nb Si	A 5.9: ER 318Si	FM5	F-No. 6	3/14
70	CEWELD 347Si	14343-A: G 19 9 Nb Si	A 5.9: ER 347Si	FM5	F-No. 6	3/14
71	CEWELD 2209 Duplex	14343-A: G 22 9 3 N L	A 5.9: ER 2209	FM5	F-No. 6	3/14
72	CEWELD 2594 Super Duplex	14343-A: G 25 9 4 NL	A 5.9: ~ER 2594	FM5	F-No. 6	3/15
73	CEWELD 904L	14343-A: G 20 25 5 Cu L	A 5.9: ER 385	FM5	F-No. 6	3/15
74	CEWELD 327	14343-A: G 25 4	-	FM5	F-No. 6	3/15
75	CEWELD 320	14343-B: G 20 33 3	A 5.9: ER 320	FM5	F-No. 6	3/15
76	CEWELD 25-35Nb	14343-A: ~ G 25 35 Zr	-	FM5	F-No. 6	3/15
77	CEWELD ER 630 (17-4 PH)	14343-B: G 630	A 5.9: ER 630	FM5	F-No. 6	3/15
<b>11. GTA (TIG) WIRE RODS FOR WELDING OF STAINLESS STEEL</b>						
78	CEWELD 307Si Tig	14343-A: W 18 8 MnSi	A 5.9: ~ER 307	FM5	F-No. 6	3/16
79	CEWELD 308L Tig	14343-A: W 19 9 L	A 5.9: ER 308L	FM5	F-No. 6	3/16
80	CEWELD 308L Si Tig	14343-A: W 19 9 L Si	A 5.9: ER 308LSi	FM5	F-No. 6	3/16
81	CEWELD 308H Tig	14343-A: W 19 9 H	A 5.9: ER 308	FM5	F-No. 6	3/16
82	CEWELD 309LSi Tig	14343-A: W 23 12 L Si	A 5.9: ER 309LSi	FM5	F-No. 6	3/16
83	CEWELD 309LMo Tig	14343-A: W 23 12 3 L	A 5.9: ER 309LMo	FM5	F-No. 6	3/16
84	CEWELD 310 Tig	14343-A: W 25 20	A 5.9: ~ER 310	FM5	F-No. 6	3/16
85	CEWELD 310LMo Tig	14343-A: W 25 22 2 N L	A 5.9: ER 310LMo	FM5	F-No. 6	3/16
86	CEWELD 312 Tig	14343-A: W 29 9	A 5.9: ER 312	FM5	F-No. 6	3/16



Overview - **SOLID WIRE**

No.	Product Name	ISO	ASME	FM Group	F-Number:	Page
87	CEWELD 316L Tig	14343-A: W 19 12 3 L	A 5.9: ER 316L	FM5	F-No. 6	3/16
88	CEWELD 316LSi Tig	14343-A: W 19 12 3 LSi	A 5.9: ER 316LSi	FM5	F-No. 6	3/17
89	CEWELD 316H Tig	14343-A: W 19 12 3 H	A 5.9: ER 316H	FM5	F-No. 6	3/17
90	CEWELD 316LMn Tig	14343-A: W 20 16 3 Mn N L	A 5.9: ER 316LMn	FM5	F-No. 6	3/17
91	CEWELD 317L Tig	14343-A: W 18 15 3 L	A 5.9: ER 317L	FM5	F-No. 6	3/17
92	CEWELD 318Si Tig	14343-A: W 19 12 3 Nb Si	A 5.9: ER 318Si	FM5	F-No. 6	3/17
93	CEWELD 320 Tig	14343-B: W 320	A 5.9: ER 320LR	FM5	F-No. 6	3/17
94	CEWELD 347Si Tig	14343-A: W 19 9 Nb Si	A 5.9: ER 347Si	FM5	F-No. 6	3/17
95	CEWELD 2209 Duplex Tig	14343-A: W 22 9 3 N L	A 5.9: ER 2209	FM5	F-No. 6	3/17
96	CEWELD 2594 Tig Super Duplex	14343-A: W 25 9 4 N L	A 5.9: ER 2594	FM5	F-No. 6	3/18
97	CEWELD 904L Tig	14343-A: W 20 25 5 Cu L	A 5.9: ER 385	FM5	F-No. 6	3/18
98	CEWELD 25-35Nb Tig	14343-A: W Z 25 35Nb	A 5.9: --	FM5	F-No. 6	3/18
99	CEWELD ER 630 Tig (17-4 PH)	14343-B: W 630	A 5.9: ER 630	FM5	F-No. 6	3/18
<b>12. GMA /GTA (MIG/TIG) WIRE AND ROD FOR NICKEL BASED ALLOYS</b>						
100	CEWELD Nicro 600 CEWELD Nicro 600 Tig	18274: S Ni 6082 (NiCr20Mn3Nb)	A 5.14: ER NiCr-3	FM6	F-No. 43	3/18
101	CEWELD Nicro 601 CEWELD Nicro 601 Tig	18274: S Ni 6601(NiCr23Fe15Al)	A 5.14: ER NiCrFe-11	FM6	F-No. 43	3/18
102	CEWELD NiCro 602 CA CEWELD NiCro 602 CA Tig	18274: S Ni 6025 (NiCr25Fe10AlY)	A 5.14: ER NiCrFe-12	FM6	F-No. 43	3/18
103	CEWELD Nicro 625 CEWELD Nicro 625 Tig	18274: S Ni 6625(NiCr22Mo9Nb)	A 5.14: ER NiCrMo-3	FM6	F-No. 43	3/18
104	CEWELD NiCro 718 CEWELD NiCro 718 Tig	18274: S Ni 7718 (NiFe19Cr19Nb5Mo3)	A 5.14: ER NiFeCr-2	FM6	F-No. 43	3/19
105	CEWELD NiCro 52 CEWELD NiCro 52 Tig	18274: S Ni 6052 (NiCr30Fe9)	A 5.14: ER NiCrFe-7	FM6	F-No. 43	3/19
106	CEWELD NiCro 52M Tig	18274: S Ni 6054 (NiCr29Fe9)	A 5.14: ER NiCrFe-7A	FM6	F-No. 43	3/19
107	CEWELD NiCro 72M CEWELD NiCro 72M Tig	18274: S Ni 6073 (NiCr38AlNbTi)	A 5.14: ER NiCr-7	FM6	F-No. 43	3/19
108	CEWELD Nicro 92 Tig	18274: Ni 7092 (NiCr15Ti3Mn)	A 5.14: ER NiCrFe-6	FM6	F-No. 43	3/19
109	CEWELD Nicro FM 53MD Tig	18274: S Ni 6693 (NiCr29Fe4Al3)	A 5.14: ER NiCrFeAl-1	FM6	F-No. 43	3/19
110	CEWELD NiTi3 CEWELD NiTi3 Tig	18274: S Ni 2061 (NiTi3)	A 5.14: ER Ni-1	FM6	F-No. 41	3/19
111	CEWELD NiCu30Mn CEWELD NiCu30Mn Tig	18274: S Ni 4060 (NiCu30Mn3Ti)	A 5.14: ER NiCu-7	FM6	F-No. 42	3/20
112	CEWELD NiCrCo 617 CEWELD NiCrCo 617 Tig	18274: S Ni 6617 (NiCr22Co12Mo9)	A 5.14: ER NiCrCoMo-1	FM6	F-No. 43	3/20
113	CEWELD NiCrMo 59 CEWELD NiCrMo 59 Tig	18274: S Ni 6059 (NiCr23Mo16)	A 5.14: ER NiCrMo-13	FM6	F-No. 43	3/20
114	CEWELD NiCrMo 622 CEWELD NiCrMo 622 Tig	18274: S Ni 6022 (NiCr21Mo13Fe4W3)	A 5.14: ER NiCrMo-10	FM6	F-No. 43	3/20
115	CEWELD Alloy 230 Tig	18274: S Ni 6231 (NiCr22W14Mo2)	A 5.14: ER NiCrWMo-1	FM6	F-No. 43	3/20
116	CEWELD Alloy 33	14343-B:~ S Z 33 32 1 Cu N L	A 5.9: ER 33-31	FM6	F-No. 45	3/20
117	CEWELD Alloy 740H CEWELD Alloy 740H Tig	-	-	FM6	F-No. 45	3/20
118	CEWELD Alloy 825 CEWELD Alloy 825 Tig	18274-A: S Ni8065 (NiFe30Cr21Mo3)	A 5.14: ER NiFeCr-1	FM6	F-No. 45	3/21
119	CEWELD Alloy B3	18274: S Ni 1067 (NiMo30Cr)	A 5.14: ER NiMo-10	FM6	F-No. 44	3/21
120	CEWELD Alloy C-2000	18274: S Ni 6200 (NiCr23Mo16Cu2)	A 5.14: ER NiCrMo-17	FM6	F-No. 43	3/21
121	CEWELD Alloy C-276 CEWELD Alloy C-276 Tig	18274: S Ni 6276 (NiCr15Mo16Fe6W4)	A 5.14: ER NiCrMo-4	FM6	F-No. 43	3/21
122	CEWELD Alloy X	18274: S Ni 6002 (NiCr21Fe18Mo9)	A 5.14: ER NiCrMo-2	FM6	F-No. 43	3/21
<b>13. GTA (TIG) WIRE AND ROD COBALT ALLOYS</b>						
123	CEWELD DUR 1 TIG	14700: S Co3	A 5.21: ER CoCr-C	-	F-No. 71	3/21
124	CEWELD DUR 6 TIG	14700: S Co2	A 5.21: ER CoCr-A	-	F-No. 71	3/21
125	CEWELD DUR 12 TIG	14700: S Co3	A 5.21: ER CoCr-B	-	F-No. 71	3/22

# SOLID WIRE - Overview

No.	Product Name	ISO	ASME	FM Group	F-Number:	Page
126	CEWELD DUR 21 TIG	14700: S Co1	A 5.21: ER CoCr-E	-	F-No. 71	3/22
<b>14. GMA/GTA (MIG/MAG/TIG) WIRE AND ROD FOR HARDFACING</b>						
127	CEWELD MA 350	14700: S Fe2	A 5.21: ER Fe-1	-	F-No. 71	3/22
128	CEWELD MA 6500 Tig	14700: S Fe3	-	-	F-No. 71	3/22
129	CEWELD MA 600 CEWELD MA 600 Tig	14700: S Fe8	A 5.21: ER FeCr-A	-	F-No. 71	3/22
130	CEWELD MA 650	14700: S Fe8	A 5.21: ER Fe-8	-	F-No. 71	3/22
131	CEWELD MA HSS	14700: S Fe4	A 5.21: ER Fe-8	-	F-No. 71	3/22
132	CEWELD MA SS 2343 CEWELD MA SS 2343 Tig	14700: S Fe3	~(AISI J 438 b) H 11	-	F-No. 71	3/22
133	CEWELD MA SS 2367	14700: S Fe8	-	-	F-No. 71	3/22
<b>15. GMAW/GTAW (MAG/TIG) STAINLESS WIRE AND ROD FOR HARDFACING</b>						
134	CEWELD MA 617	14700: S Fe8 (X35CrMo17)	-	FM5	F-No. 6	3/23
135	CEWELD 410 CEWELD 410 Tig	14700: S Fe7 14343-A: W Z 13	A 5.9: ER 410	FM5	F-No. 6	3/23
136	CEWELD MA 4115 CEWELD MA 4115 Tig	14700: S Fe8 14343-A: W 17	A 5.9: ER 430	FM5	F-No. 6	3/23
<b>16. GMA/GTA (MIG/TIG) WIRE AND ROD OF ALUMINIUM ALLOYS</b>						
137	CEWELD AI99,0 CEWELD AI99,0 Tig	18273: S AL 1100 / AL 99,0Cu	A 5.10: ER 1100	-	F-No. 21	3/23
138	CEWELD AI99,7 CEWELD AI99,7 Tig	18273: S AL 1070 / AL 99,7	A 5.10: ER 1070	-	F-No. 21	3/23
139	CEWELD AI99,5 Ti CEWELD AI99,5 Ti Tig	18273: S AL 1450 / AL 99,5 Ti	A 5.10: ER 1450	-	F-No. 21	3/23
140	CEWELD AISi 5 CEWELD AISi 5 Tig	18273: S AI 4043A / AISi5(A)	A 5.10: ER 4043(A)	-	F-No. 23	3/23
141	CEWELD AISi 12 CEWELD AISi 12 Tig	18273: S AI 4047A / AISi12(A)	A 5.10: ER 4047(A)	-	F-No. 23	3/23
142	CEWELD AIMg 3 CEWELD AIMg 3 Tig	18273: S AI 5754 / AIMg3	A 5.10: ER 5754	-	F-No. 22	3/24
143	CEWELD AIMg 4,5 Mn CEWELD AIMg 4,5 Mn Tig	18273: S AL5183 / AIMg4,5Mn0,7(A)	A 5.10: ER 5183	-	F-No. 22	3/24
144	CEWELD AIMg 4,5MnZr	18273: S AI5087 / AIMg4,5MnZr(A)	A 5.10: ER 5087	-	F-No. 22	3/24
145	CEWELD AIMg 5 CEWELD AIMg 5 Tig	18273: S AI5356 / AIMg5Cr(A)	A 5.10: ER 5356	-	F-No. 22	3/24
<b>17. GMA/GTA (MIG/TIG) WELDING OF TITANIUM ALLOYS</b>						
146	CEWELD ERTi-1	24304: STi-0100 (Ti99,8)	A 5.16: ER Ti 1	-	F-No. 51	3/24
147	CEWELD ERTi-2	24304: STi-0120 (Ti 99,6)	A 5.16: ER Ti 2	-	F-No. 51	3/24
148	CEWELD ERTi-5	24304: STi-6402C(TiAl6V4B)	A 5.16: ER Ti 5	-	F-No. 55	3/24
149	CEWELD ERTi-7	24304: STi-2401 (TiPd0,2A)	A 5.16: ER Ti 7	-	F-No. 51	3/24
150	CEWELD ERTi-12	24304: STi-3401 (TiNi0,7Mo0,3)	A 5.16: ER Ti 12	-	F-No. 54	3/25
<b>18. TB BRAZING OF COPPER ALLOYS</b>						
151	CEWELD CuAg CEWELD CuAg Tig	24373: Cu1897 / CuAg1	A 5.7: ER Cu	-	F-No. 31	3/25

Overview - **SOLID WIRE**

No.	Product Name	ISO	ASME	FM Group	F-Number:	Page
152	CEWELD CuSi3 CEWELD CuSi3 Tig	24373: Cu 6560 / CuSi3Mn1	A 5.7: ER CuSi-A	-	F-No. 32	3/25
<b>19. GMA/GTA (MIG/TIG) WELDING OF COPPER ALLOYS</b>						
153	CEWELD CuSn CEWELD CuSn Tig	24373: Cu 1898A / CuSn1	A 5.7: ER Cu	-	F-No. 31	3/25
154	CEWELD CuSn 6 CEWELD CuSn 6 Tig	24373: Cu 5180A / CuSn6P	A 5.7: ER CuSn-A	-	F-No. 33	3/25
155	CEWELD CuSn 12 CEWELD CuSn 12 Tig	24373: Cu 5410 / CuSn12P	-	-	F-No. 33	3/25
156	CEWELD CuAl 8 CEWELD CuAl 8 Tig	24373: Cu 6100 / CuAl7	A 5.7: ER CuAl-A1	-	F-No. 36	3/25
157	CEWELD CuAl8Ni2 CEWELD CuAl8Ni2 Tig	24373: Cu 6327 / CuAl8Ni2Fe2Mn2	-	-	F-No. 36	3/25
158	CEWELD CuAl8Ni6 CEWELD CuAl8Ni6 Tig	24373: Cu 6328 / CuAl9Ni5Fe3Mn2	A 5.7: ER CuNiAl	-	F-No. 37	3/26
159	CEWELD CuAl9Fe	24373: Cu6180 / CuAl10Fe	A 5.7: ER CuAl-A2	-	F-No. 36	3/26
160	CEWELD CuNi10Fe CEWELD CuNi10Fe Tig	24373: Cu 7061 / CuNi10	-	-	F-No. 37	3/26
161	CEWELD CuNi30Fe CEWELD CuNi30Fe Tig	24373: Cu 7158 / CuNi30Mn1FeTi	A 5.7: ER CuNi	-	F-No. 34	3/26
162	CEWELD CuMn13Al7 CEWELD CuMn13Al7 Tig	24373: Cu 6338 / CuMn13Al8Fe3Ni2	A 5.7: ER CuMnNiAl	-	F-No. 37	3/26

## SOLID WIRE

TYPE	EN -ISO and ASME -AWS	MECHANICAL PROPERTIES	ANALYSIS	APPLICATION
------	-----------------------	-----------------------	----------	-------------

## 1. GMA (MAG) WELDING OF NON-AND LOW-ALLOYED STEEL

CEWELD SG 1	9606-1: FM2 Sect IX QW-432: F-No. 6 14341-A: G 42 2 M21/C1 2Si A 5.18: ER 70S-3	T > 560 MPa Y > 380 MPa E > 24% I ~ 90J (20 °C)	C < 0,08 Mn ~ 1,3 Si ~ 0,5	SG 1 is a copper coated solid welding wire developed for MAG (GMA) welding of non- and low-alloyed steels with low silicon and manganese content. Suitable for galvanizing after welding.
CEWELD SG TITAN	9606-1: FM2 Sect IX QW-432: F-No. 6 14341-A: G 46 A M21 2Ti A 5.18: ER 70S-2	T = 560-600 MPa Y > 460 MPa E > 22% I ~ 60J (-30 °C)	C < 0,04 Mn ~ 1,2 Si ~ 0,5 Ti + Zr ~ 0,17	SG TITAN is a copper coated solid welding wire with addition of deoxidizing elements for improved welding properties on galvanized or zinc-coated plate.
CEWELD SG 2	9606-1: FM2 Sect IX QW-432 : F-No. 6 14341-A: G 42 3 C1 3Si 1 / G 42 4 M21 3Si 1 A 5.18: ER 70S-6	T > 540 MPa Y > 430 MPa E > 24% I ~ 70J (-40 °C) CO <sub>2</sub> I ~ 90J (-40 °C) M21	C < 0,08 Mn ~ 1,45 Si ~ 0,85	SG 2 is a copper coated welding wire for welding non and -low alloyed steels up to < 420 MPa yield strength.
CEWELD SG 3	9606-1: FM2 Sect IX QW-432: F-No. 6 14341-A: G 42 4 C1 3Si 1 / G 46 4 M21 G4S 1 A 5.18: ER 70S-6	T > 560 MPa Y > 460 MPa E > 24% I ~ 90J (-40 °C) CO <sub>2</sub> I ~ 110J (-40 °C) M21	C < 0,08 Mn ~ 1,75 Si ~ 0,9	SG 3 is a copper coated welding wire for welding non and -low alloyed steels up to < 460 MPa yield strength.
CEWELD SG Mo	9606-1: FM2 Sect IX QW-432: F-No. 6 14341-A: G422C12MoG466M212Mo 21952-A: G MoSi A 5.28: ER 70S-A1/ ER 80S-G	T > 580 MPa Y > 460 MPa E > 22% I ~ 55J (-40 °C) with PWHT T > 500 MPa Y > 400 MPa E > 19% I ~ 200J (20 °C)	C < 0,09 Mn ~ 1,2 Si ~ 0,6 Mo ~ 0,5	SG Mo is a copper coated welding wire for welding of 0,5% Mo steels. Excellent welding properties. Excellent to be used for creep resisting service at temperatures up to 500 °C. Typical: 15Mo3, 16Mo3, A 204 Gr. A - C ASTM A106 Gr. A-B-C

## 2. GMA (MAG) WELDING OF CREEP RESISTANT STEEL

CEWELD SG CrMo1	9606-1: FM3 Sect IX QW-432 : F-No. 6 21952-A: G CrMo1Si A 5.28: ER 80S-G	with PWHT T > 560 MPa Y > 355 MPa E > 22% I ~ 80J (20 °C)	C < 0,09 Mn ~ 1,0 Si ~ 0,6 Cr ~ 1,2 Mo ~ 0,5	SG CrMo1 is a copper coated welding wire for high temperature creep resistant 1.25%Cr-0.5%Mo ferritic steel, i.e. P11/P12. These steels are used for creep resisting applications up to ~550 °C. Typical: 13CrMo44, 13CrMo4-5, A 387 Gr. 11-12, 24CrMo5, GS 17CrMo55, GS 22CrMo54, G 17CrMo5-5, G22CrMo5-4
CEWELD ER 80S-B2	9606-1: FM3 Sect IX QW-432: F-No. 6 21952-B: G 1CM A 5.28: ER 80S-B2	with PWHT T > 560 MPa Y > 460 MPa E > 22% I ~ 80J (20 °C)	C < 0,09 Mn ~ 0,6 Si ~ 0,6 Cr ~ 1,3 Mo ~ 0,5	ER80S-B2 is a copper coated welding wire for high temperature creep resistant 1.25%Cr-0.5%Mo ferritic steel, i.e. P11/P12. These steels are used for creep resisting applications up to ~550 °C.
CEWELD SG CrMo2	9606-1: FM3 Sect IX QW-432: F-No. 6 21952-A: G CrMo2Si A 5.28: ER 90S-G / ER 90S-B3 (mod)	with PWHT T > 520 MPa Y > 420 MPa E > 22% I ~ 80J (20 °C)	C < 0,08 Mn ~ 0,9 Si ~ 0,6 Cr ~ 2,5 Mo ~ 1,0	SG CrMo2 is a copper coated welding wire for high temperature creep resistant 2.25%Cr-1%Mo ferritic steel, i.e. P21/P22. These steels are used for creep resisting applications up to ~600 °C.
CEWELD ER 90S-B3	9606-1: FM3 Sect IX QW-432: F-No. 6 21952-B: G 62 M 2C1M2 A 5.28: ER 90S-B3	with PWHT T > 620 MPa Y > 540 MPa E > 22% I ~ 80J (20 °C)	C < 0,09 Mn ~ 0,55 Si ~ 0,55 Cr ~ 2,5 Mo ~ 1,05	ER90S-B3 is a copper coated welding wire for high temperature creep resistant 2.25%Cr-1%Mo ferritic steel, i.e. P21/P22. These steels are used for creep resisting applications up to ~600 °C. Typical: 10CrMo9.10, 12CrMo9-10, 10CrSiMoV7, 12CrSiMo8, 30CrMoV9, GS-18CrMo9.10
CEWELD SG CrMo5	9606-1: FM4 Sect IX QW-432: F-No. 6 21952-A: G CrMo5Si A 5.28: ER 80S-B6	with PWHT T > 590 MPa Y > 460 MPa E > 18% I ~ 110J (20 °C)	C < 0,08 Mn ~ 0,6 Si ~ 0,35 Cr ~ 6,0 Mo ~ 0,6	SG CrMo5 is a copper coated welding wire for high temperature creep resistant 5%Cr0.5%Mo ferritic steel, i.e. P5. The 5%Cr-0.5%Mo creep resistant alloy is used for service up to ~600 °C particularly.

TYPE	EN -ISO and ASME -AWS	MECHANICAL PROPERTIES	ANALYSIS	APPLICATION
CEWELD ER 80S-B8	9606-1: FM4 Sect IX QW-432: F-No. 6 21952-A: G CrMo9 A 5.28: ER 80S-B8	with PWHT T > 590 MPa Y > 460 MPa E > 18% I ~ 110J (20 °C)	C 0,06 - 0,1 Mn 0,3 - 0,7 Si 0,3 - 0,6 Cr 8,5 - 10,0 Mo 0,8 - 1,20 Ni < 1,0 V < 0,15	ER80S-B8 is a copper coated welding wire for high temperature creep resistant 9%Cr-1%Mo martensitic steel, i.e. P9. The 9%Cr-1%Mo creep resistant alloy is used for service up to ~600 °C.
CEWELD ER 90S-B9 (P91)	9606-1: FM4 Sect IX QW-432: F-No. 6 21952-A: G CrMo91 A 5.28: ~ER 90S-B9	with PWHT T > 590 MPa Y > 460 MPa E > 18% I ~ 60J (20 °C)	C 0,06 - 0,1 Mn 0,3 - 0,7 Si 0,3 - 0,6 Cr 8,5 - 10,0 Mo 0,8 - 1,20 Ni < 1,0 V < 0,15	ER90S-B9(P91) is a copper coated welding wire for high temperature creep resistant, modified 9%Cr1%Mo martensitic steel (T91/P91). T91/P91 steel is commonly used at service temperatures up to 600 °C. V, Nb and N additions provide this 'creep strength enhanced ferritic' (CSEF) alloy with improved high temperature creep resistance compared to standard CrMo creep resistant alloys.
CEWELD ER 90 S-G (P92)	9606-1: FM4 Sect IX QW-432: F-No. 6 21952-A: G ZCrMoWVNb9 0,5 1,5 A 5.28: ER 90S-G	with PWHT T > 620 MPa Y > 540 MPa E > 17% I ~ 110J (20 °C)	C < 0,1 Mn ~ 0,45 Si ~ 0,4 Cr ~ 8,8 Mo ~ 0,4 Ni ~ 0,50 V ~ 0,2 Nb ~ 0,05 W ~ 1,6	ER90S-G (P92) is a copper coated welding wire for high temperature creep resistant, modified 9%Cr-1,7%W-0,5%Mo martensitic steel (T9/P92). T92/P92 steel is commonly used at service temperatures up to 620 °C. W,V,Nb and N additions provide this 'creep strength enhanced ferritic' (CSEF) alloy with improved high temperature creep resistance compared to standard CrMo creep resistant alloys.
<b>3. GMA (MAG) WELDING OF WEATHER RESISTANT STEEL</b>				
CEWELD SG Corten	9606-1: FM1 Sect IX QW-432: F-No. 6 14341-A: G 46 4 M21 Z 3Ni1Cu A 5.28: ER 80S-G	T > 570 MPa Y > 450 MPa E > 24% I ~ 60J (-40 °C)	C < 0,08 Mn ~ 1,4 Si ~ 0,8 Ni ~ 0,8 Cu ~ 0,4	SG Corten is a copper coated welding wire for welding of weather resistant steels. Typical: S235JRW-S460JRW, WTSt 37, WTSt 52, Corten A, B, C, Patinax 37, RBH 35, Acor 37, Acor 50, HSB 51, HSB 55 C, 1.8962, 1.8963, 1.8965, 1.8960
<b>4. GMA (MAG) WELDING OF FINE GRAIN STEEL</b>				
CEWELD ER 80S-D2	9606-1: FM1 Sect IX QW-432: F-No. 6 14341-A: G 50 5 M21 4Mo, 14341-B: S4M31 A 5.28: ER 80S-D2 / ER 90S-D2	T > 620 MPa Y > 540 MPa E > 18% I > 47J (-50 °C)	C < 0,09 Mn ~ 1,8 Si ~ 0,7 Mo ~ 0,5 Cu ~ 0,1	ER80S-D2 is a copper coated welding wire for welding of high strength steels, used predominantly after stress relieving. May find use for joining creep resistance steels up to about 500 °C but the SG Mo wire would be the more usual choice.
CEWELD SG Ni1	9606-1: FM1 Sect IX QW-432: F-No. 6 14341-A: G 50 6 M21 3Ni1 A 5.28: ER 80S-Ni1	T > 560 MPa Y > 500 MPa E > 22% I > 47J (-60 °C)	C < 0,09 Mn ~ 1,1 Si ~ 0,5 Ni ~ 0,9	SG Ni1 is a copper coated welding wire for welding steels where impact properties are required at -60 °C. Applications include structural, oil and gas and offshore steelwork.
CEWELD SG Ni2,5	9606-1: FM1 Sect IX QW-432: F-No. 6 14341-A: G 46 7 M21 2Ni2 A 5.28: ER 80S-Ni2	T > 570 MPa Y > 470 MPa E > 20% I > 47J (-70 °C)	C < 0,1 Mn ~ 1,1 Si ~ 0,5 Ni ~ 2,5	SGNi2,5 is a copper coated welding wire for welding steels where impact properties are required at -60 °C. Applications include structural, oil and gas and offshore steelwork.
CEWELD SG NiMo1	9606-1: FM2 Sect IX QW-432: F-No. 6 14341-B: G 50 5 M21 3Ni1Mo A 5.28: ER 80S-G	T > 570 MPa Y > 490 MPa E > 17% I ~ 65J (-50 °C)	C < 0,06 Mn ~ 1,2 Si ~ 0,4 Ni ~ 0,9 Mo < 0,2	SGNiMo1 is a copper coated welding wire for welding steels where impact properties are required at -50 °C. Applications include structural, oil and gas and offshore steelwork.
CEWELD SG3 NiMo1	9606-1: FM2 Sect IX QW-432: F-No. 6 16834-A: G 62 6 M21 Mn3Ni1Mo A 5.28: ER 90S-G	T > 760 MPa Y > 620 MPa E > 20% I > 47J (-60 °C)	C < 0,12 Mn ~ 1,75 Si ~ 0,5 Ni ~ 0,9 Mo ~ 0,55	SG3 NiMo1 is a copper coated welding wire for welding steels where impact properties are required at -60°C. Applications include structural, oil and gas and offshore steelwork.
CEWELD ER 100 S-G(L)	9606-1: FM2 Sect IX QW-432: F-No. 6 16834-A: G 62 5 M21 Mn3NiCrMo A 5.28: ER 100 S-G	T > 700 MPa Y > 620 MPa E > 20% I ~ 70J (-50 °C)	C < 0,14 Mn ~ 1,6 Si ~ 0,7 Cr ~ 0,6 Ni ~ 0,6 Mo ~ 0,3 V ~ 0,03	ER 100 S-G(L) is a copper coated welding wire. Extreme crack resistant alloy with high mechanical properties and excellent welding characteristics. High impact strength at sub zero temperatures down to -50 °C. Applications include structural, oil and gas and offshore steelwork.



## SOLID WIRE

TYPE	EN -ISO and ASME -AWS	MECHANICAL PROPERTIES	ANALYSIS	APPLICATION
CEWELD ER 100 S-G	9606-1: FM2 Sect IX QW-432: F-No. 6 16834-A: G 69 4 M21 Mn3Ni1CrMo A 5.28: ER 100S-G, ER 110S-G	T > 790 MPa Y > 690 MPa E > 16% I ~ 47J (-40 °C)	C < 0,12 Mn ~1,6 Si ~ 0,6 Cr ~ 0,3 Ni ~ 1,5 Mo ~ 0,3 V ~ 0,1	ER 100 S-G is a copper coated welding wire. Extreme crack resistant alloy with high mechanical properties and excellent welding characteristics. High impact strength at sub zero temperatures down to - 40 ° C. Applications include structural, oil and gas and offshore steelwork.
CEWELD ER 110 Ti	9606-1: FM2 Sect IX QW-432: F-No. 6 16834-A: G 69 6 M21 Mn4Ni1,5CrMo A 5.28: ER 110S-G	T > 790 MPa Y > 700 MPa E > 16% I ~ 70J (-40 °C) I ~ 47J (-60 °C)	C < 0,09 Mn ~ 1,65 Si ~ 0,5 Cr ~ 0,25 Ni ~ 1,4 Mo ~ 0,45 Ti ~ 0,07	ER 110 Ti is a copper coated welding wire. Extreme crack resistant alloy with high mechanical properties and excellent welding characteristics. High impact strength at sub zero temperatures down to - 60 ° C. Applications include structural, oil and gas and offshore steelwork.
CEWELD ER 110 S-1	9606-1: FM2 Sect IX QW-432: F-No. 6 16834-A: G 79 5 M21 Mn4Ni1.5CrMo A 5.28: ER 110S-1	T > 880 MPa Y > 790 MPa E > 16 % I > 47J (-50 °C)	C < 0,12 Mn ~1,6 Si ~ 0,6 Cr ~ 0,3 Ni ~ 1,8 Mo ~ 0,55	ER 110 S-1 is a copper coated welding wire. Extreme crack resistant alloy with high mechanical properties and excellent welding characteristics. High impact strength at sub zero temperatures down to -50 ° C. Applications include structural, oil and gas and offshore steelwork.
CEWELD ER 120 S-G	9606-1: FM2 Sect IX QW-432: F-No. 6 16834-A: G 89 6 M21 Mn4Ni2CrMo A 5.28: ER 120S-G	T > 940 MPa Y > 890 MPa E > 15 % I > 47J (-60 °C)	C < 0,13 Mn ~1,8 Si ~ 0,7 Cr ~ 0,3 Ni ~ 2,2 Mo ~ 0,6	ER 120 S-G is a copper coated welding wire. Extreme crack resistant alloy with high mechanical properties and excellent welding characteristics. High Impact strength at sub zero temperatures down to -60 ° C. Applications include structural, oil and gas and offshore steelwork.
CEWELD ER 120 S-1	9606-1: FM2 Sect IX QW-432: F-No. 6 16834-A: G 89 5 M Mn4Ni2,5CrMo A 5.28: ER 120S-G	T > 1040 MPa Y > 960 MPa E > 14 % I > 47J (-50 °C)	C < 0,13 Mn ~ 1,9 Si ~ 0,6 Cr ~ 0,4 Ni ~ 2,4 Mo ~ 0,4	ER 120 S-1 is a copper coated welding wire Extreme crack resistant alloy with high mechanical properties and excellent welding characteristics. High impact strength at sub zero temperatures down to -50 ° C. Applications include structural, oil and gas and offshore steelwork.
5. GTA (TIG) WELDING OF NONALLOYED STEEL				
CEWELD SG 1 Tig	9606-1: FM1 Sect IX QW-432: F-No. 6 636-A: W 42 2 2Si A 5.18: ER 70S-3	T > 510 MPa Y > 420 MPa E > 20% I > 100J (-20 °C)	C < 0,14 Mn ~ 1,1 Si ~ 0,5	SG 1 Tig is a copper coated solid welding wire developed for Tig welding of un and -low alloyed steels with low silicon and manganese content.
CEWELD SG TITAN Tig	9606-1: FM1 Sect IX QW-432: F-No. 6 636-A: W 46 2 2Ti A 5.18: ER 70S-2	T > 560MPa Y> 460 MPa E > 20% I > 47J (-20 °C)	C < 0,14 Mn ~ 1,2 Si ~ 0,5 Ti+Zr ~ 0,17	SG TITAN Tig is a copper coated solid Tig welding wire with addition of deoxidizing elements for improved welding properties on galvanized or zinc-coated plate.
CEWELD SG 2 Tig	9606-1: FM1 Sect IX QW-432: F-No. 6 636-A: W 46 5 Si1 A 5.18: ER 70S-6	T > 560 MPa Y > 460 MPa E > 20% I > 47J (-50 °C)	C < 0,14 Mn ~ 1,45 Si ~ 0,85	SG 2 Tig is a copper coated welding wire for Tig welding of un and -low alloyed steels up to < 460 MPa yield strength.
CEWELD SG 3 Tig	9606-1: FM1 Sect IX QW-432: F-No. 6 636-A: W 50 5 4Si1 A 5.18: ER 70S-6	T > 560 MPa Y > 500 MPa E > 18% I > 80J (-50 °C)	C < 0,14 Mn ~ 1,75 Si ~ 1,0	SG 3 Tig is a copper coated welding wire for Tig welding of un and -low alloyed steels up to < 500 MPa yield strength.

TYPE	EN -ISO and ASME -AWS	MECHANICAL PROPERTIES	ANALYSIS	APPLICATION
<b>CEWELD SG Mo Tig</b>	<b>9606-1:</b> FM1 / FM3 <b>Sect IX QW-432:</b> F-No. 6 <b>636-A:</b> W 46 4 2Mo <b>21952-A:</b> W MoSi <b>A 5.28:</b> ER 70S-A1	T > 580 MPa Y > 460 MPa E > 22% I ~ 55J (-40 °C)	C < 0,12 Mn ~ 1,2 Si ~ 0,6 Mo ~ 0,5	<b>SG Mo Tig</b> is a <b>copper coated welding wire</b> for Tig welding of <b>0,5% Mo</b> steels. Excellent welding properties. Perfect to be used for creep resisting service at temperatures <b>up to 500 °C</b> .
<b>6. GTA (TIG) WELDING OF CREEP RESISTANT STEEL</b>				
<b>CEWELD SG CrMo1 Tig</b>	<b>9606-1:</b> FM3 <b>Sect IX QW-432:</b> F-No. 6 <b>21952-A:</b> W CrMo1Si <b>A 5.28:</b> ER 80S-G	<b>with PWHT</b> T > 560 MPa Y > 460 MPa E > 22% I ~ 80J (20 °C)	C < 0,14 Mn ~ 1,0 Si ~ 0,6 Cr ~ 1,1 Mo ~ 0,5	<b>SG CrMo1 Tig</b> is a <b>copper coated Tig welding wire</b> for high temperature creep resistant <b>1.25%Cr-0.5%Mo</b> ferritic steel, i.e. P11/P12. These steels are used for creep resisting applications <b>up to ~550°C</b> .
<b>CEWELD ER 80S-B2 Tig</b>	<b>9606-1:</b> FM3 <b>Sect IX QW-432:</b> F-No. 6 <b>21952-B:</b> W1CM <b>A 5.28:</b> ER 80S-B2	<b>with PWHT</b> T > 560 MPa Y > 460 MPa E > 19%	C < 0,12 Mn ~ 0,6 Si ~ 0,6 Cr ~ 1,3 Mo ~ 0,5	<b>ER80S-B2 Tig</b> is a <b>copper coated Tig welding wire</b> for high temperature creep resistant <b>1.25%Cr-0.5%Mo</b> ferritic steel, i.e. P11/P12. These steels are used for creep resisting applications <b>up to ~ 550°C</b> .
<b>CEWELD ER 70S-B2L Tig</b>	<b>9606-1:</b> FM3 <b>Sect IX QW-432:</b> F-No. 6 <b>21952-B:</b> W1CM <b>A 5.28:</b> ER 80S-B2	<b>with PWHT</b> T > 560 MPa Y > 460 MPa E > 21%	C < 0,04 Mn ~ 0,6 Si ~ 0,6 Cr ~ 1,3 Mo ~ 0,5	<b>ER70S-B2L Tig</b> is <b>copper coated Tig welding wire</b> it is a <b>low carbon content</b> variation of the <b>ER80S-B2 Tig</b> and is designed for the Tig welding of <b>1.25%Cr-0.5%Mo</b> steel that require a lower as-welded hardness.
<b>CEWELD SG CrMo2 Tig</b>	<b>9606-1:</b> FM3 <b>Sect IX QW-432:</b> F-No. 6 <b>21952-A:</b> W CrMo2Si <b>A 5.28:</b> ER 90S-G / ER 90S-B3 (mod)	<b>with PWHT</b> T > 520 MPa Y > 400 MPa E > 18% I > 80J (20 °C)	C < 0,08 Mn ~ 0,9 Si ~ 0,6 Cr ~ 2,5 Mo ~ 1,0	<b>SG CrMo2 Tig</b> is a <b>copper coated Tig welding wire</b> fo high temperature creep resistant <b>2.25%Cr-1%Mo</b> ferritic steel, i.e. P21/P22. These steels are used for creep resisting applications <b>up to ~ 600°C</b> .
<b>CEWELD ER 90S-B3 Tig</b>	<b>9606-1:</b> FM3 <b>Sect IX QW-432:</b> F-No. 6 <b>21952-B:</b> W 2C1M <b>A 5.28:</b> ER 90S-B3	<b>with PWHT</b> T > 500 MPa Y > 400 MPa E > 18% I > 47J (20 °C)	C < 0,09 Mn ~ 0,55 Si ~ 0,50 Cr ~ 2,5 Mo ~ 1,1	<b>ER90S-B3 Tig</b> is a <b>copper coated Tig welding wire</b> for high temperature creep resistant <b>2.25%Cr-1%Mo</b> ferritic steel, i.e. P21/P22. These steels are used for creep resisting applications <b>up to ~ 600°C</b> .
<b>CEWELD SG CrMo5 Tig</b>	<b>9606-1:</b> FM4 <b>Sect IX QW-432:</b> F-No. 6 <b>21952-A:</b> W CrMo1Si <b>A 5.28:</b> ER 80S-G	<b>with PWHT*</b> T > 550 MPa Y > 450 MPa E > 18% I ~ 100J (20 °C)	C < 0,10 Mn ~ 0,6 Si ~ 0,4 Cr ~ 6,0 Mo ~ 0,6	<b>SG CrMo5 Tig</b> is a <b>copper coated Tig welding wire</b> for high temperature creep resistant <b>5%Cr0.5%Mo</b> ferritic steel, i.e. P5. The 5%Cr-0.5%Mo creep resistant alloy is used for service <b>up to ~600 °C</b> particularly.
<b>CEWELD ER80S-B8 Tig</b>	<b>9606-1:</b> FM4 <b>Sect IX QW-432:</b> F-No. 6 <b>21952-A:</b> W CrMo9 <b>A 5.28:</b> ER 80S-B8	<b>with PWHT*</b> T > 590 MPa Y > 470 MPa E > 18% I > 60J (20 °C)	C < 0,08 Mn ~ 0,6 Si ~ 0,4 Cr ~ 8,9 Mo ~ 1,0 Ni ~ 0,2	<b>ER80S-B8 Tig</b> is a <b>copper coated Tig welding wire</b> for high temperature creep resistant <b>9%Cr-1%Mo</b> martensitic steel, i.e. P9. The 9%Cr-1%Mo creep resistant alloy is used for service <b>up to ~600 °C</b> .
<b>CEWELD ER90S-B9(P91)Tig</b>	<b>9606-1:</b> FM4 <b>Sect IX QW-432:</b> F-No. 6 <b>21952-A:</b> W CrMo91 <b>A 5.28:</b> ER 90S-B9	<b>with PWHT*</b> T > 620 MPa Y > 520MPa E > 18% I > 47J (20 °C)	C < 0,1 Mn ~ 0,5 Si ~ 0,32 Cr ~ 9,0 Mo ~ 1,0 Ni ~ 0,60 V ~ 0,20 Nb ~ 0,04	<b>ER90S-B9(P91) Tig</b> is a <b>copper coated Tig welding wire</b> for high temperature creep resistant modified <b>9%Cr1%Mo</b> martensitic steel ( <b>T91/P91</b> ). T91/P91 steel is commonly used at service temperatures <b>up to 600 °C</b> . <b>V, Nb and N</b> additions provide this 'creep strength enhanced ferritic' (CSEF) alloy with improved high temperature creep resistance compared to standard CrMo creep resistant alloys.
<b>CEWELD ER 90S-G(P92)Tig</b>	<b>9606-1:</b> FM4 <b>Sect IX QW-432:</b> F-No. 6 <b>21952-A:</b> WZCrMoWVNb 9 0.5 1.5 <b>A 5.28:</b> ER 90S-G	<b>with PWHT*</b> T > 620MPa Y > 540 MPa E > 17% I > 47J (20 °C)	C < 0,1 Mn ~ 0,50 Si ~ 0,35 Cr ~ 9,0 Mo ~ 0,8 Ni ~ 0,50 V ~ 0,20 Nb ~ 0,05 W ~ 1,6	<b>ER90S-G(P92)Tig</b> is a <b>copper coated welding wire</b> for high temperature creep resistant, <b>modified 9%Cr-1,7%W-0,5%Mo</b> martensitic steel (T9/P92). <b>T92/P92 steel</b> is commonly used at service temperatures <b>up to 620 °C</b> . <b>W,V,Nb and N</b> additions provide this 'creep strength enhanced ferritic' (CSEF) alloy with improved high temperature creep resistance compared to standard CrMo creep resistant alloys.

## SOLID WIRE

TYPE	EN -ISO and ASME -AWS	MECHANICAL PROPERTIES	ANALYSIS	APPLICATION
<b>7. GTA (TIG) WELDING OF WEATHER RESISTANT STEEL</b>				
CEWELD SG Corten Tig	9606-1: FM1 Sect IX QW-432: F-No. 6 636-A: W 42 4 Z2NiCu A 5.28: ER 80S-G	T > 550 MPa Y > 450 MPa E > 20% I > 47J (-40 °C)	C < 0,08 Mn ~ 1,4 Si ~ 0,8 Ni ~ 0,8 Cu ~ 0,4	<b>SG Corten Tig</b> is a copper coated Tig welding wire for welding of weather resistant steels. Typical: WTSt 37, WTSt 52, Corten A, B, C, Patinax 37, RBH 35, Acor 37, Acor 50, HSB 51, HSB 55 C, 1.8962, 1.8963, 1.8965, 1.8960
<b>8. GTA (TIG) WELDING OF FINE GRAIN STEEL</b>				
CEWELD ER80S-D2 Tig	9606-1: FM1 Sect IX QW-432: F-No. 6 636-B: W 57A 4 W4M31 21952-A: W Z4Mo A 5.28: ER 80S-D2 / ER 90S-D2	T > 620 MPa Y > 540 MPa E > 18% I > 47J (-50 °C)	C < 0,12 Mn ~ 1,8 Si ~ 0,7 Mo ~ 0,5	<b>ER80S-D2 Tig</b> is a copper coated Tig welding wire for welding of high strength steels, used predominantly after stress relieving. May find its use for joining creep resistance steels up to about 500 °C but the ED-SG Mo wire would be the more usual choice.
CEWELD SG Ni1 Tig	9606-1: FM1 Sect IX QW-432: F-No. 6 636-A: W 46 6 3Ni1 A 5.28: ER 80S-Ni1	T > 550 MPa Y > 470 MPa E > 20% I > 47J (-60 °C)	C < 0,09 Mn ~ 1,05 Si ~ 0,5 Ni ~ 0,9	<b>SG Ni1 Tig</b> is a copper coated Tig welding wire for welding steels where impact properties are required at -60 °C. Applications include structural, oil and gas and offshore steelwork.
CEWELD SG Ni2,5 Tig	9606-1: FM1 Sect IX QW-432: F-No. 6 636-A: W 42 9 2Ni2 A 5.28: ER 80S-Ni2	T > 550 MPa Y > 470 MPa E > 24% I > 47J (-90 °C)	C < 0,09 Mn ~ 1,05 Si ~ 0,5 Ni ~ 2,45	<b>SG Ni2,5 Tig</b> is a copper coated welding wire for welding steels where impact properties are required at -60 °C. Applications include structural, oil and gas and offshore steelwork.
CEWELD SG CrMoV6 Tig	9606-1: - Sect IX QW-432 : - 16834-A: - A 5.28: - Air 9117 - 15CDV6 ~ ER 90S-G	T > 700 MPa Y > 620 MPa E > 18% I ~ 65J (-50 °C)	C ~ 0,14 Mn ~ 1,00 Si ~ 0,15 Cr ~ 1,4 V ~ 0,25 Mo ~ 0,9	<b>SG CrMoV6 Tig</b> is a copper coated welding wire is used for welding matching, and similar, composition base materials. The weld deposit provides high strength, actual strength being dependent on heat treatment Preheat, interpass temperature and PWHT will be dependent on application and base material. The wire finds its application in the aerospace and motorsports industries, and also in the repair of some tool steels.
CEWELD ER 100 S-G Tig	9606-1: FM2 Sect IX QW-432 : F-No. 6 16834-A: W 69 4 11 Mn3Ni1CrMo A 5.28: ER 100S-G, ER 110S-G	T > 800 MPa Y > 690 MPa E > 20% I > 47J (-40 °C)	C < 0,09 Mn ~ 1,6 Si ~ 0,5 Cr ~ 0,3 Ni ~ 1,4 Mo ~ 0,3	<b>ER 100 S-G Tig</b> is a copper coated welding wire. Extreme crack resistant alloy with high mechanical properties and excellent welding characteristics. High impact strength at sub zero temperatures down to -40 °C Applications include structural, oil and gas and offshore steelwork. <b>S690QL, Dillidur 690, Weldox 700, Naxtra 70, S700MC, Alform 700 M, Domex 700 MC, PAS 70, S770QL</b>
CEWELD ER 110 S-1 Tig	9606-1: FM2 Sect IX QW-432 : F-No. 6 16834-A: W 79 4 11 Mn3Ni1CrMo A 5.28: ER 110S-1	T > 890 MPa Y > 790 MPa E > 16% I > 65J (-50 °C)	C < 0,09 Mn ~ 1,6 Si ~ 0,5 Cr ~ 0,3 Ni ~ 1,4 Mo ~ 0,3	<b>ER 110 S-1 Tig</b> is a copper coated welding wire, with excellent flowing properties under pure Argon suitable for high strength fine grain steels in combination with excellent impact toughness at sub zero temperatures. <b>S690QL, Dillidur 690, Weldox 700, Naxtra 70, S700MC, Alform 700 M, Domex 700 MC, PAS 70, S770QL</b>
CEWELD ER 120 S-1 Tig	9606-1: FM2 Sect IX QW-432 : F-No. 6 16834-A: W 89 5 11 Mn4Ni2CrMo A 5.28: ER 120S-G	T > 940 MPa Y > 890 MPa E > 15 % I ~ 50J (-60 °C)	C < 0,09 Mn ~ 1,8 Si ~ 0,6 Cr ~ 0,3 Ni ~ 2,25 Mo ~ 0,55	<b>ER 120 S-1 Tig</b> is a Copper coated welding wire. Extreme crack resistant alloy with high mechanical properties and excellent welding characteristics. High impact strength at sub zero temperatures down to -60 °C. Applications include structural, oil and gas and offshore steelwork.
<b>9. OXY-ACETYLENE / OXY-FUEL WELDING OF NON-ALLOYED STEEL</b>				
CEWELD G1	9606-1: FM1 Sect IX QW-432: F-No. 6 20378: O I A 5.2: R45	T > 360 MPa Y > 260 MPa E > 20 % I ~ 30J (0 °C)	C < 0,09 Mn ~ 0,5 Si < 0,1	<b>G1</b> is a rod for gas welding suitable for joining tubes and plates. Highly fluid weld metal
CEWELD G2	9606-1: FM1 Sect IX QW-432: F-No. 6 20378: O II A 5.2: R60	T > 400 MPa Y > 300 MPa E > 20 % I ~ 50J (20 °C)	C < 0,1 Mn ~ 1,1 Si ~ 0,15	<b>G2</b> is a rod for gas welding suitable for joining tubes and plates. Highly fluid weld metal

TYPE	EN -ISO and ASME -AWS	MECHANICAL PROPERTIES	ANALYSIS	APPLICATION
CEWELD G3	9606-1: FM 1 Sect IX QW-432: F-No. 6 20378: O III A 5.2: ~ R60	T > 400 MPa Y > 300 MPa E > 20 % I ~ 65J (20 °C)	C < 0,1 Mn ~ 1,1 Si ~ 0,1 Ni ~ 0,4	G3 is a rod for gas welding suitable for joining tubes and plates. Highly fluid weld metal
CEWELD G4	9606-1: FM1 Sect IX QW-432: F-No. 6 20378: O IV A 5.2: ~ R60	T > 440 MPa Y > 260 MPa E > 20 % I > 60J (20 °C)	C < 0,12 Mn ~ 1,1 Si ~ 0,2 Mo ~ 0,5	G4 is a rod for gas welding suitable for joining tubes and plates. Highly fluid weld metal
<b>10. GMAW/GTAW (MAG/TIG) WELDING OF STAINLESS STEEL</b>				
CEWELD 410 NiMo	9006-1: FM5 Sect IX QW-432: F-No. 6 14343-A: G 13 4 / W 13 4	T > 750 MPa Y > 500 MPa E > 15 %	C ~ 0,02 Mn ~ 0,4 Si ~ 0,4 Cr ~ 12,0	410NiMo is a stainless solid welding wire and rod of the 12% Cr, 4.5% Ni, 0.5% Mo type. 410NiMo is used for welding similar martensitic and martensitic-ferritic steels in different applications, such as hydro turbines. Water and steam turbine parts of the same kind, thermoshock and high heat resistant. 1.4313, 1.4002, (G)X5CrNi(Mo) 13 4, X6CrAl 13, Grade CA 6 NM.
CEWELD 410 NiMo Tig	DIN 8556: SG-X3CrNi 13 4 A 5.9: ER 410NiMo	HRC 38 after PWHT HB 250	Ni ~ 4,5 Mo ~ 0,5 Cu ~ 0,07 Co ~ 0,1	
CEWELD 430	9606-1: FM5 Sect IX QW-432: F-No. 6 14343-A: G 17 / W 17	T > 450 MPa Y > 300 MPa E > 15 %	C ~ 0,02 Si ~ 0,3 Mn ~ 0,4 Cr ~ 17,0	430 is a martensitic stainless steel welding wire for ferritic stainless steels It is a 17% chromium solid wire. 1.4511, X3CrNb17, 1.4512, 1.4510, 1.4526, 1.4509, 1.4016, X6Cr17, AISI 430
CEWELD 430 Tig	8555: MSG 5 M 250-C A 5.9: ER 430		Ni ~ 0,5 Mo ~ 0,06 Cu ~ 0,1	
CEWELD 430LNb	9606-1: FM5 Sect IX QW-432: F-No. 6 14343-A: G 18 L Nb	T > 1100 MPa Y > 990 MPa E > 3 %	C ~ 0,01 Si ~ 0,5 Mn ~ 0,7 Ni ~ 0,1 Cr ~ 16,5 Mo ~ 0,05 Cu ~ 0,04 Nb ~ 0,3	430LNb is stainless steel welding wire developed and designed for the automotive industry and used for production of exhaust systems and catalytic converters.. The wire should be used when there is a need for good resistance to corrosion and thermal fatigue. 1.4511, X3CrNb17, 1.4512, 1.4510, 1.4526, 1.4509, 1.4016, X6Cr17, AISI, 430, 409, 439, 436, 441
	8555: MSG 5 M 250-C A 5.9: ER 430LNb			
CEWELD 430LNbTi	9606-1: FM5 Sect IX QW-432: F-No. 6 14343-A: G 17	T > 410 MPa Y > 220 MPa E > 15 %	C ~ 0,02 Si ~ 0,5 Mn ~ 0,6 Ni ~ 0,15 Cr ~ 18,0 Mo ~ 0,2 Ti ~ 0,4 Nb ~ 0,7	430LNb/Ti is stainless steel welding wire developed and designed for the automotive industry and used for production of exhaust systems and catalytic converters.. The wire should be used when there is a need for good resistance to corrosion and thermal fatigue. Stabilized ferritic stainless steels, Austenitic stainless steels and in both homogeneous and heterogeneous sheet metal configurations (sheets of different grades welded together). 1.4509, 1.4510, 1.4511, 1.4512, etc.
	8555: MSG 5 M 250-C A 5.9: ER 430Nb (mod)	HB 140 after PWHT HB 133		
CEWELD 307Si	9606-1: FM5 Sect IX QW-432: F-No. 6 14343-A: G 18 8 MnSi	T 550-650 MPa Y > 360 MPa E > 30% I ~ 100J (20 °C)	C < 0,09 Mn ~ 6,0 Si ~ 0,9 Cr ~ 18,0 Ni ~ 8,0	307Si is a solid welding wire for welding stainless steel to low alloyed steels (dissimilar welds), buffer layers before hard facing, rails crossings, armor plate, austenitic manganese steels and other difficult to weld steels.
CEWELD 308LSi	9606-1: FM5 Sect IX QW-432: F-No. 6 14343-A: G 19 9 L Si	T 600-650 MPa Y > 460 MPa E > 36% I ~ 70J (-60 °C) I ~ 45J (-196 °C)	C < 0,03 Mn ~ 1,4 Si ~ 0,6 Cr ~ 20,0 Ni ~ 10,0 Mo < 0,75	308LSi is a solid wire for welding stainless steel types with an alloy content between 16 to 21% Cr and 8 to 13 % Ni, for both stabilized and un-stabilized types. High weld metal quality and an attractive bead appearance. W.no: 1.4306, 1.4301, 1.4541, 1.4550, 1.4311, 1.4546, 1.4312, 1.4300, 1.4312, 1.4371, 1.4541, 1.4543, 1.4550, 1.4452, AISI 202, 302, 304L, 304, 305, 321, 347, 304 LN, ASTM A320 Grade B8C/D, 302
	A 5.9: ER 308LSi			
CEWELD 308H	9606-1: FM5 Sect IX QW-432: F-No. 6 14343-A: G 19 9 H	T 550-650 MPa Y > 400 MPa E > 24% I ~ 80J (20 °C)	C < 0,06 Mn ~ 1,4 Si ~ 0,6 Cr 19,5 - 22 Ni 9,0 - 11 Mo < 0,75	308H is a solid high carbon wire for welding stainless steel types with an alloy content between 16 to 21% Cr and 8 to 13 % Ni with high carbon content for high temperature applications. High weld metal quality and an attractive bead appearance. W.no: 1.4306, 1.4301, 1.4541, 1.4550, 1.4311, 1.4546, 1.4312, 1.4300, 1.4312, 1.4371, 1.4541, 1.4543, 1.4550, 1.4452
	A 5.9: ER 308 / ER 308H			
CEWELD 309LSi	9606-1: FM5 Sect IX QW-432: F-No. 6 14343-A: W 23 12 L Si	T 600-650 MPa Y > 440 MPa E > 38% I ~ 55J (20 °C)	C < 0,03 Mn ~ 1,3 Si ~ 0,8 Cr 23 - 25 Ni 12 - 14 Mo < 0,75	309LSi is solid wire for welding dissimilar steels and 13%Cr/18%Cr stainless steels, and is suitable for welding the first layer on low carbon steel to obtain a AISI 304 clad layer. Buffer layers before hard-facing, dissimilar joints between ferritic and austenitic steels and or difficult to weld steels such as: 42CrMo4, C45, 42MnV7, tool steels, heat resistant steels etc.
	A 5.9: ER 309 LSi			



## SOLID WIRE

TYPE	EN -ISO and ASME -AWS	MECHANICAL PROPERTIES	ANALYSIS	APPLICATION
CEWELD 309H	9606-1: FM5 Sect IX QW-432: F-No. 6 14343-A: G 22 12 H A 5.9: ER 309	T 550-700 MPa Y > 400 MPa E > 25% I ~ 70J (20 °C)	C < 0,12 Mn ~ 1,3 Si ~ 0,7 Cr 23 - 25 Ni 12 - 14 Mo < 0,75	<b>309H is solid wire with high carbon content</b> for Cladding on low alloyed steels in case a <b>18/8 CrNi layer</b> is required in the first layer. Scale resistant <b>up to 1050° C.</b> , <b>Buffer layers</b> before hard facing, cladding and joining of similar austenitic steels, specially recommended for use in oxidizing gasses with nitrogen and gasses containing small amounts of oxygen. <b>W.no: 1.2780, 1.4541, 1.4550, 1.4712, 1.4724, 1.4742, 1.4825, X15CrNiSi20 12 (1.4828), X 40 CrNiSi20 9 (1.4826)</b>
CEWELD 309LMo	9606-1: FM5 Sect IX QW-432: F-No. 6 14343-A: G 23 12 3 L A 5.9: ~ER 309 LMo	T 600-720 MPa Y > 400 MPa E > 31% I ~ 60J (-40 °C)	C < 0,02 Mn ~ 1,4 Si ~ 0,5 Cr 23 - 25 Ni 12 - 14 Mo 2,0 - 3,0	<b>309LMo</b> is a solid wire which operates with very stable, spatter free arcs. This wire deposits low carbon weld metal of about <b>23%Cr-13%Ni-2.3%Mo</b> . <b>Cladding on low alloyed steels in case a 18/8/2 CrNiMo layer is required in the first layer. 1.4401, 1.4404, 1.4406, 1.4410, 1.4437, 1.4571, 1.4580</b>
CEWELD 310	9606-1: FM5 Sect IX QW-432: F-No. 6 14343-A: G 25 20 A 5.9: ER 310	T > 590 MPa Y > 390 MPa E > 45% I ~ 100J (20 °C) I ~ 60J (-196 °C)	C < 0,15 Mn ~ 1,8 Si ~ 0,5 Cr 25 - 27 Ni 20 - 22,5 Mo < 0,75	<b>310 is a solid wire for welding heat-resistant austenitic steels of the 25% Cr, 20% Ni types.</b> 310 has good general oxidation resistance, especially at <b>high temperatures</b> , due to its high Cr content. The alloy is fully austenitic and is therefore sensitive to hot cracking. Stainless and high temperature steels: <b>W.no: 1.4826, 1.4828, 1.4835, 1.4837, 1.4840, 1.4841, 1.4845, 1.4846, 1.4847, 1.4848, 1.4710, 1.4713, 1.4724, 1.4726, 1.4742, 1.4745, 1.4762</b>
CEWELD 312	9606-1: FM5 Sect IX QW-432: F-No. 6 14343-A: G 29 9 A 5.9: ER 312	T > 800 MPa 660 Y > 640 MPa 450 E > 30% I ~ 50J (20 °C)	C < 0,15 Mn ~ 1,4 Si ~ 0,5 Cr 28 - 32 Ni 8,0 - 10 Mo < 0,75	<b>312 is a solid wire for welding dissimilar and difficult to weld steels. Buffer layers</b> before hard facing, armored plate, exhaust systems, high, manganese austenitic steel, heterogeneous welding, difficult to weld and unknown steels. Scale resistance <b>up to 1150°C</b> , crack and wear resistant, suitable for rebuilding worn-out parts. Excellent corrosion resistance against high temperature liquid acids. Buffer layers, armor plate, 409, 304, difficult to weld steels such as: <b>25CrMo4, 42CrMo4, 50CrMo4, 42MnV7, 1.7218, 1.7225, 1.7228, 1.7223, AISI: 4130, 4140, 4150, C45, C60, tool steel repairs etc..</b>
CEWELD 316LSi	9606-1: FM5 Sect IX QW-432: F-No. 6 14343-A: G 19 12 3 LSi A 5.9: ER 316LSi	T > 550 MPa Y > 350 MPa E > 35% I ~ 120J (20 °C) I ~ 55J (-196 °C)	C < 0,03 Mn 1,0 - 2,5 Si 0,65 - 1,0 Cr 18 - 20 Ni 11 - 14 Mo 2,0 - 3,0	<b>316LSi is a solid stainless wire with increased silicon content.</b> It offers good <b>general corrosion resistance</b> , particularly to corrosion in acid and chlorinated environments. The alloy has a low carbon content which makes it particularly recommended when <b>there is a risk of intergranular corrosion</b> . The higher silicon content improves the welding properties such as wetting and results in a bright seam. <b>W.no: 1.4583, 1.4435, 1.4436, 1.4404, 1.4406, 1.4408, 1.4401, 1.4571, 1.4580, 1.4406</b>
CEWELD 316H	9606-1: FM5 Sect IX QW-432: F-No. 6 14343-A: G 19 12 3 H A 5.9: ER 316H	T > 570 MPa Y > 380 MPa E > 35% I ~ 70J (20 °C)	C 0,04 - 0,08 Mn 1,0 - 2,5 Si 0,3 - 0,65 Cr 18 - 20 Ni 11 - 14 Mo 2,0 - 3,0	<b>316H is designed for welding 316/316H austenitic stainless steels operating at high temperatures (500-800°C)</b> under long term creep conditions. This filler metal can also be used for <b>welding 321/321H and 347/347H grades</b> in high temperature structural service. This is particularly important in thick highly restrained weldments, since the possibility of premature service failure by intergranular HAZ cracking is reduced by using more ductile weld metal rather than 347H. <b>W.no: 347H 316/316H, CF10M, BS 316S51, 316S52, 316S53, 316C16, 316C71, UNS S31609</b>
CEWELD 316LMn	9606-1: FM5 Sect IX QW-432: F-No. 6 14343-A: G 20 16 3 Mn N L A 5.9: ER 316LMn	T > 620 MPa Y > 440 MPa E > 35% I ~ 120J (20 °C) I ~ 75J (-196 °C)	C < 0,03 Mn 7,0 - 7,5 Si 0,4 - 0,5 Cr 20 - 20,5 Ni 15 - 16 Mo 2,0 - 3,0	<b>316LMn is a solid welding wire for welding fully austenitic CrNiMnMo stainless steels</b> and low temperature steels. Particularly suited for corrosion conditions in urea synthesis plants for welding work on steel <b>X 2 CrNiMo 18 12</b> and for over-lay cladding of Type 1.4455.. Well suited for joining and cladding applications with matching and similar austenitic CrNi(N) and CrNiMo(Mn,N steels/cast steel grades. <b>W.no: 1.4583, 1.4435, 1.4436, 1.4404, 1.4406, 1.4408, 1.4401, 1.4571, 1.4580, 1.4406</b>
CEWELD 317L	9606-1: FM5 Sect IX QW-432: F-No. 6 14343-A: G 18 15 3 L A 5.9: ER 317 L	T > 580 MPa Y > 320 MPa E > 35% I ~ 65J (20 °C)	C < 0,03 Mn 1,0 - 2,5 Si 0,3 - 0,65 Cr 18,5 - 20,5 Ni 13 - 15 Mo 3,0 - 4,0	<b>317 L is a solid wire welding wire, suitable to weld 19Cr/13Ni/3.5Mo austenitic stainless steels type 317L.</b> The <b>increased Mo</b> content compared to grade 316L assures increased resistance to pitting and crevice corrosion. Also suitable for the welding of 316, 316L and 316LN grades, when it is necessary to provide better pitting corrosion resistance. Suitable for service temperatures <b>from -60 °C to +300 °C</b> . <b>W.no: 1.4439, 1.4429, 1.4438, 1.4583, X2CrNiMoN 17 13 5, X2CrNiMoN 17 13 3, X2CrNiMo 18 15 4, X10CrNiMoNb 18 12, 317LN, (TP)316LN, 317L, non magnetic, ferrite free.</b>
CEWELD 318Si	9606-1: FM5 Sect IX QW-432: F-No. 6 14343-A: G 19 12 3 Nb Si A 5.9: ER 318Si	T > 580 MPa Y > 460 MPa E > 35% I ~ 100J (20 °C) I ~ 70J (-60 °C)	C < 0,08 Mn 1,0 - 2,5 Si 0,3 - 0,65 Cr 18,5 - 20,5 Ni 13 - 15 Mo 3,0 - 4,0 Nb < 8xC - 1,0	<b>318Si is a solid wire for GMAW, suitable to weld 19Cr/12Ni/3Mo stabilized Ti grades</b> like 1.4571 / 316Ti. Also suitable for the welding of similar non-stabilized grades 316 or 316L. <b>318 Si</b> is suitable for service temperatures <b>from - 60 °C to +400 °C</b> and has high resistance to intergranular corrosion. <b>W.no: 1.4571/ X6CrNiMoTi17-12-2, 1.4580/ X6CrNiMoNb17-12-2, 1.4401/ X5CrNiMo17-12-2, 1.4581/ GX5CrNiMoNb19-11-2, 1.4437/ GX6CrNiMo18-12, 1.4583/ X10CrNiMoNb18-12, 1.4436/ X3CrNiMo17-13-3, AISI 316L, 316Ti, 316Cb</b>
CEWELD 347Si	9606-1: FM5 Sect IX QW-432: F-No. 6 14343-A: G 19 9 Nb Si A 5.9: ER 347Si	T 600-680 MPa Y > 390 MPa E > 37% I ~ 80J (20 °C) I ~ 40J (-196 °C)	C < 0,08 Mn 1,0 - 2,5 Si 0,65 - 1,0 Cr 19 - 21,5 Ni 9 - 11 Mo < 0,75 Nb < 10xC - 1,0	<b>347Si is a solid wire for GMAW with higher Si content</b> suitable to weld <b>18Cr/10Ni stabilized with Ti or Nb</b> austenitic stainless steels grades 321 and 347. Also suitable for welding similar non-stabilized grades 304 or 304L. 347Si has high resistance to intergranular corrosion. <b>W.no: 1.4550/ X6CrNiNb18-10, 1.4541/ X6CrNiTi18-10, 1.4552/ GX5CrNiNb19-11, 1.4301/ X5CrNi18-10, 1.4312/ GX10CrNi18-8, 1.4546/ X5CrNiNb18-10, 1.4311/ X2CrNi18-10, 1.4306/ X2CrNi19-11 AISI 347, 321, 302, 304, 304L, 304LN, ASTM A296 Gr. CF 8 C, A157 Gr. C9, A320 Gr. B8C or D</b>



TYPE	EN -ISO and ASME -AWS	MECHANICAL PROPERTIES	ANALYSIS	APPLICATION
CEWELD 2209 Duplex	9606-1: FM5 Sect IX QW-432: F-No. 6 14343-A: G 22 9 3 N L A 5.9: ER 2209	T > 550 MPa Y > 450 MPa E > 20% I ~ 40J (-60 °C)	C < 0,03 Mn 0,5 - 2,0 Si < 0,9 Cr 21,5 - 23,5 Ni 7,5 - 9,5 Mo 2,5 - 3,5 N 0,08 - 0,2 Cu < 1,5	<b>2209 Duplex</b> is a <b>solid wire electrode for GMAW</b> , suitable for <b>welding duplex stainless steels</b> grades 2205 and 2304. Weld metal exhibits corrosion resistance similar to grade 904L in most applications. <b>2209 Duplex</b> is also suitable to weld grade 2205 or grade 2304 to mild steel. <b>W.no: 1.4162, 1.4462, X2CrNiMoN 22 5 3, 1.4362, X2CrNiN 23 4, 1.4463, 1.4460, 1.4583</b>
CEWELD 2594 Super Duplex	9606-1: FM5 Sect IX QW-432: F-No. 6 14343-A: G 25 9 4 NL A 5.9: ~ER 2594	T > 620 MPa Y > 550 MPa E > 28% I ~ 55J (-40 °C)	C < 0,03 Mn < 2,5 Si < 1,0 Cr 24 - 27 Ni 8,0 - 10,5 Mo 2,5 - 4,5 W < 1,0 N 0,2 - 0,3 Cu < 1,5	<b>2594 Super Duplex</b> is a <b>solid wire electrode for GMAW</b> for welding austenitic-ferritic, stainless alloys of the <b>25% Cr, 7% Ni, 4% Mo, low C types</b> . Welding wrought, forged or cast super duplex stainless steels for service in the as-welded Condition. <b>Heterogeneous welding between super duplex stainless steels and dissimilar welds between other stainless and mild or low alloyed steels</b> . The alloy is widely used in applications in which corrosion resistance is of the utmost importance. The pulp & paper industry, offshore and gas industry are areas of interest. corrosion. <b>UNS S32550 :UR 52 N, Ferralium 255, UNS S32520 :UR 52 N+, UNS S32750 :SAF 2507, UR 47 N+, UNS S32760 :ZERON 100, UNS 32760, UR 76 N, SM22Cr, SAF 2507, ASTM S32760 (ZERON 100), S32550 and S31260.</b>
CEWELD 904L	9606-1: FM5 Sect IX QW-432: F-No. 6 14343-A: G 20 25 5 Cu L A 5.9: ER 385	T > 510 MPa Y > 320 MPa E > 25% I ~ 55J (-40 °C)	C < 0,025 Mn 1,0 - 2,5 Si < 0,5 Cr 19 - 21,5 Ni 24,0 - 26,0 Mo 4,2 - 5,2 Cu 1,2 - 2,0	<b>904L</b> is used for <b>welding materials of similar chemical composition</b> which are used for fabrication of equipment and vessels for handling of sulfuric acid and many chloride containing media. This filler metal may also find applications for <b>joining Type 317L material</b> where improved corrosion resistance in specific media is needed. In order to reduce the tendency for fissuring and hot cracking, the low melting constituents such as carbon, silicon, and phosphorus are controlled to lower levels in this alloy. <b>W.no: 1.4539 /X1NiCrMoCu25-20-5, 1.4439/ X2CrNiMoN17-13-5, 1.4537/ X1CrNiMo-CuN25-25-5 UNS N08904, S31726</b>
CEWELD 327	9606-1: FM5 Sect IX QW-432: F-No. 6 14343-A: G 25 4 A 5.9: --	T > 650 MPa Y > 450 MPa E > 15% I ~ 50J (20 °C)	C < 0,15 Mn 1,0 - 2,5 Si < 2,0 Cr 24 - 27 Ni 4,0 - 6,0 Mo < 0,5	<b>327</b> is a <b>solid wire for GMAW</b> , suitable for high temperature applications. Wire of ferritic-austenitic chromium-nickel steel for MAG welding of heat-resistant steels, weld metal is scale-resistant <b>up to 1100 °C</b> . <b>High chromium-alloyed welding wire</b> (ER 327-ER 329) based on a <b>25% Chromium and 4% Nickel</b> deposit for cladding and joining components against corrosion, high-heat and wear resistance. <b>W.no: 1.4710, 1.4745, 1.4712, 1.4762, 1.4713, 1.4773, 1.4722, 1.4776, 1.4724, 1.4820, 1.4729, 1.4821, 1.4740, 1.4822, 1.4742, 1.4823</b>
CEWELD 320	9606-1: FM5 Sect IX QW-432: F-No. 6 14343-A: G 20 33 3 A 5.9: ER 320	T > 550 MPa Y > 320 MPa E > 25% I ~ 80J (20 °C) I ~ 40J (-196 °C)	C < 0,07 Mn < 2,5 Si < 0,6 Cr 19 - 21,0 Ni 32 - 36 Mo 2,0 - 3,0 Cu 3,0 - 4,0 Nb 8x%C-1,0	<b>320</b> was <b>designed specifically to withstand sulfuric acid</b> . Its <b>nickel, chromium, molybdenum and copper levels</b> all provide excellent general corrosion resistance. Restricted carbon <b>plus niobium</b> stabilization permits welded fabrications to be used in corrosive environments, normally without post-weld heat treatment. At <b>33% nickel</b> , Alloy 320 has practical immunity to chloride stress corrosion cracking. This alloy is often chosen to solve SCC problems, which may occur with 316L stainless.
CEWELD 25-35Nb	9606-1: FM5 Sect IX QW-432: F-No. 6 14343-A: ~ G 25 35 Zr A 5.9: -	T > 600 MPa Y > 400 MPa E > 8 %	C 0,3- 0,5 Mn ~ 1,7 Si < 1,1 Cr 25 - 27 Ni 34 - 36 Nb 1,2 - 1,5 Ti < 0,15	<b>25-32Nb</b> is solid wire <b>for heat resistant stainless steel</b> with similar composition and high carbon content. <b>W.no: 1.4852 GX40NiCrSiNb35-25, Alloy HP10Cb, Paralloy CR39W, Lloyds T57 Centralloy H101</b>

## SOLID WIRE

TYPE	EN -ISO and ASME -AWS	MECHANICAL PROPERTIES	ANALYSIS	APPLICATION
CEWELD ER 630 (17-4 PH)	9606-1: FM5 Sect IX QW-432: F-No. 6 14343-B: 630 A 5.9: ER 630	T > 930 MPa Y > 725 MPa E > 5%	C < 0,05 Mn 0,25–0,75 Si < 0,75 Cr 16 - 16,75 Ni 4 - 5 Mo < 0,75 Cu 3,25 - 4,0 Nb 0,15 - 0,3	ER 630 (17-4 PH) is a solid wire, precipitation hardening stainless steel used for welding materials of similar chemical composition such as 17-4 and 17-7.
<b>11. GTA (TIG) WIRE RODS FOR WELDING OF STAINLESS STEEL</b>				
CEWELD 307Si Tig	9606-1: FM5 Sect IX QW-432: F-No. 6 14343-A: W 18 8 MnSi A 5.9: ~ER 307	T 550-650 MPa Y > 360 MPa E > 24% I ~ 100J (20 °C)	C 0,04 - 0,14 Mn 3,3 - 4,75 Si 0,3 - 0,65 Cr 19,5 - 22 Ni 8,0 - 10	307Si Tig is a solid wire for TIG welding of stainless steel to low alloyed steels (dissimilar welds), buffer layers before hard facing, rails crossings, Armor plate, austenitic manganese steels and other difficult to weld steels. 42CrMo4, C45, 42MnV7, tool steels, 1.3401, X120Mn12 etc.
CEWELD 308L Tig	9606-1: FM5 Sect IX QW-432: F-No. 6 14343-A: W 19 9 L A 5.9: ER 308L	T 600-650 MPa Y > 460 MPa E > 36% I ~ 70J (-60 °C) I ~ 45J (-196 °C)	C < 0,04 Mn 1,0 - 2,5 Si 0,3 - 0,65 Cr 19,5 - 22 Ni 9,0 - 11 Mo < 0,75 Cu < 0,75	308L Tig is a solid wire for TIG-welding stainless steel types with an alloy content between 16 to 21% Cr and 8 to 13 % Ni, for both stabilized and un-stabilized types. High weld metal quality and a attractive bead appearance. W.no: 1.4306, 1.4301, 1.4541, 1.4550, 1.4311, 1.4546, 1.4312, 1.4300, 1.4312, 1.4371, 1.4541, 1.4543, 1.4550, 1.4452 AISI 202, 302, 304L, 304, 305, 321, 347, 304 LN ASTM A320 Grade B8C/D, 302
CEWELD 308LSi Tig	9606-1: FM5 Sect IX QW-432: F-No. 6 14343-A: W 19 9 L Si A 5.9: ER 308L Si	T 600-650 MPa Y > 460 MPa E > 36% I ~ 70J (-60 °C) I ~ 45J (-196 °C)	C < 0,03 Mn 1,0 - 2,5 Si 0,65 - 1,2 Cr 19,5 - 22 Ni 9,0 - 11 Mo < 0,75 Cu < 0,75	308LSi Tig is a solid wire for TIG-welding stainless steel types with an alloy content between 16 to 21% Cr and 8 to 13 % Ni, for both stabilized and un-stabilized types. High weld metal quality and a attractive bead appearance. W.no: 1.4306, 1.4301, 1.4541, 1.4550, 1.4311, 1.4546, 1.4312, 1.4300, 1.4312, 1.4371, 1.4541, 1.4543, 1.4550, 1.4452 AISI 202, 302, 304L, 304, 305, 321, 347, 304 LN ASTM A320 Grade B8C/D, 302
CEWELD 308H Tig	9606-1: FM5 Sect IX QW-432: F-No. 6 14343-A: W 19 9 H A 5.9: ER 308H	T 550-650 MPa Y > 400 MPa E > 24% I ~ 80J (20 °C)	C 0,04 - 0,08 Mn 1,0 - 2,5 Si 0,3 - 0,65 Cr 19,5 - 22 Ni 9,0 - 11 Mo < 0,5	308H Tig is a solid high carbon wire for TIG- welding stainless steel types with an alloy content between 16 to 21% Cr and 8 to 13 % Ni, for both stabilized and un-stabilized types. High weld metal quality and a attractive bead appearance. W.no: 1.4306, 1.4301, 1.4541, 1.4550, 1.4311, 1.4546, 1.4312, 1.4300, 1.4312, 1.4371, 1.4541, 1.4543, 1.4550, 1.4452
CEWELD 309LSi Tig	9606-1: FM5 Sect IX QW-432: F-No. 6 14343-A: W 23 12 L Si A 5.9: ER 309 LSi	T 600-650 MPa Y > 440 MPa E > 38% I ~ 55J (20°C)	C < 0, 3 Mn 1,0 - 2,5 Si 0,65 - 1,2 Cr 23 - 25 Ni 12 - 14 Mo < 0,75 Cu < 0,75	309LSi Tig is a solid wire for TIG-welding dissimilar steels and 13%Cr/18%Cr stainless steels, and is suitable for welding the first layer on low carbon steel to obtain a AISI 304 clad layer. Buffer layers before hard facing, dissimilar joints between ferritic and austenitic steels and or difficult to weld steels such as: 42CrMo4, C45, 42MnV7, tool steels, heat resistant steels etc..
CEWELD 309LMo Tig	9606-1: FM5 Sect IX QW-432: F-No. 6 14343-A: W 23 12 3 L A 5.9: ER 309LMo	T 600-720 MPa Y > 400 MPa E > 31% I ~ 60J (-40°C)	C < 0, 3 Mn 1,0 - 2,5 Si 0,65 - 1,2 Cr 23 - 25 Ni 12 - 14 Mo 2,0 - 3,0 Cu < 0,75	309LMo Tig is a solid wire for TIG-welding , similar to 309 LSi Tig with the addition of 2.0 - 3.5% molybdenum to increase pitting corrosion resistance. Suitable for joining stainless Cr-Ni steels type 309, Cr-steels and dissimilar steels like austenitic stainless steels to mild or low-alloyed steels, buffer layers and overlays on C-Mn, mild steel or low alloy steels. Cladding on low alloyed steels in case a 18/8/2 CrNiMo layer is required in the first layer. 1.4401, 1.4404, 1.4406, 1.4410, 1.4437, 1.4571, 1.4580
CEWELD 310 Tig	9606-1: FM5 Sect IX QW-432 : F-No. 6 14343-A: W 25 20 14343-B: 310 A 5.9: ER 310	T > 550 MPa Y > 350 MPa E > 20% I ~ 100J (20 °C) I ~ 60J (-196 °C)	C 0,08 - 0,15 Mn 1,0 - 2,5 Si < 0,65 Cr 24 - 28 Ni 20 - 22,5 Mo < 0,75 Cu < 0,75	310 Tig is a solid wire for TIG-welding heat-resistant austenitic steels of the 25% Cr, 20% Ni types. 310 Tig has good general oxidation resistance, especially at high temperatures, due to its high Cr content. The alloy is fully austenitic and is therefore sensitive to hot cracking. Stainless and high temperature steels: W.no: : 1.4826, 1.4828, 1.4835, 1.4837, 1.4840, 1.4841, 1.4845, 1.4846, 1.4847, 1.4848, 1.4710, 1.4713, 1.4724, 1.4726, 1.4742, 1.4745, 1.4762
CEWELD 310LMo Tig	9606-1: FM5 Sect IX QW-432: F-No. 6 14343-A: W 25 22 2 N L A 5.9: ER 310LMo	T > 510 MPa Y > 320 MPa E > 25% I ~ 120J (20 °C) I ~ 100J (-196 °C)	C < 0,03 Mn 3,5 - 6,5 Si < 1,0 Cr 24 - 27 Ni 21 - 24 Mo 1,5 - 3,0 Cu < 0,5	310LMo Tig is a solid wire for TIG-welding heat-resistant austenitic steels of the 25% Cr, 20% Ni types. 310 LMo has good general oxidation resistance, especially at high temperatures, due to its high Cr content. The alloy is fully austenitic and is therefore sensitive to hot cracking. Stainless and high temperature steels: W.no: : 1.4826, 1.4828, 1.4835, 1.4837, 1.4840, 1.4841, 1.4845, 1.4846, 1.4847, 1.4848, 1.4710, 1.4713, 1.4724, 1.4726, 1.4742, 1.4745, 1.4762

TYPE	EN -ISO and ASME -AWS	MECHANICAL PROPERTIES	ANALYSIS	APPLICATION
CEWELD 312 Tig	9606-1: FM5 Sect IX QW-432: F-No. 6 14343-A: W 29 9 A 5.9: ER 312	T > 650 MPa Y > 450 MPa E > 15% I ~ 50J (20 °C)	C < 0,15 Mn 1,0 - 2,5 Si < 1,0 Cr 28 - 32 Ni 8,0 - 10,5 Mo < 0,75 Cu < 0,75	<b>312 Tig is a solid wire for TIG welding dissimilar and difficult to weld steels. Buffer layers</b> before hard facing, armored plate, exhaust systems, high, manganese austenitic steel, heterogeneous welding, difficult to weld and unknown steels. <b>Scale resistance up to 1150 °C</b> , crack and wear resistant, suitable for rebuilding worn-out parts. Excellent corrosion resistance against high temperature liquid acids. Buffer layers, armor plate, 409, 304, <b>difficult to weld steels such as: 25CrMo4, 42CrMo4, 50CrMo4, 42MnV7, 1.7218, 1.7225, 1.7228, 1.7223, AISI: 4130, 4140, 4150, C45, C60, tool steel repairs etc..</b>
CEWELD 316L Tig	9606-1: FM5 Sect IX QW-432 : F-No. 6 14343-A: W 19 12 3 L A 5.9: ER 316L	T > 510 MPa Y > 320 MPa E > 25% I > 120J (20 °C) I > 55J (-196 °C)	C < 0,03 Mn 1,0 - 2,5 Si < 0,65 Cr 18 - 20 Ni 11 - 14 Mo 2,0 - 3,0	<b>316LTig is a solid stainless steel TIG-welding rod.</b> The alloy is widely used in the chemical and food-processing industries, as well as in shipbuilding and various types of architectural structure. <b>W.no: 1.4583,1.4435,1.4436,1.4404, 1.4406, 1.4408,1.4401,1.4571,1.4580,1.4406</b>
CEWELD 316LSi Tig	9606-1: FM5 Sect IX QW-432: F-No. 6 14343-A: W 19 12 3 LSi A 5.9: ER 316L Si	T > 510 MPa Y > 320 MPa E > 25% I ~ 120J (20 °C) I ~ 55J (-196 °C)	C < 0,03 Mn 1,0 - 2,5 Si 0,65 - 1,0 Cr 18 - 20 Ni 11 - 14 Mo 2,0 - 3,0	<b>316LSi Tig is a solid stainless TIG-wire rod.</b> It offers good general corrosion resistance, particularly to corrosion in acid and chlorinated environments. The alloy has a low carbon content which makes it particularly recommended when there is a risk of intergranular corrosion. The higher silicon content improves the welding properties such as wetting and results in a bright seam. <b>W.no: 1.4583,1.4435,1.4436,1.4404, 1.4406, 1.4408,1.4401,1.4571,1.4580,1.4406</b>
CEWELD 316H Tig	9606-1: FM5 Sect IX QW-432: F-No. 6 14343-A: G 19 12 3 H A 5.9: ER 316H	T > 550 MPa Y > 350 MPa E > 25% I ~ 70J (20 °C)	C 0,04 - 0,08 Mn 1,0 - 2,5 Si 0,3 - 0,65 Cr 18 - 20 Ni 11 - 14 Mo 2,0 - 3,0	<b>316H Tig is a solid stainless TIG-wire rod</b> designed for welding <b>316/316H austenitic stainless steels</b> operating at <b>high temperatures (500 - 800 °C)</b> under long term creep conditions. Wire rod can also be used for welding 321/321H and 347/347H grades in high temperature structural service. This is particularly important in thick highly restrained weldments, since the possibility of premature service failure by intergranular HAZ cracking is reduced by using more ductile weld metal rather than 347H. <b>W.no: 347H 316/316H, CF10M, BS 316S51, 316S52, 316S53, 316C16, 316C71, UNS S31609</b>
CEWELD 316LMn Tig	9606-1: FM5 Sect IX QW-432: F-No. 6 14343-A: W 20 16 3 Mn N L A 5.9: ER 316LMn	T > 620 MPa Y > 440 MPa E > 35% I ~ 120J (20 °C)	C < 0,03 Mn 7,0 - 7,5 Si 0,4 - 0,5 Cr 20 - 20,5 Ni 15 - 16 Mo 2,0 - 3,0	<b>316LMn Tig is a solid stainless TIG-wire rod</b> for welding fully <b>austenitic CrNiMnMo stainless steels</b> and low temperature steels. Particularly suited for corrosion conditions in urea synthesis plants for welding work on steel <b>X 2 CrNiMo 18 12</b> and for over-lay claddings of Type 1.4455.. Well suited for joining and <b>cladding applications</b> with matching and similar austenitic CrNi(N) and CrNiMo(Mn,N) steels/cast steel grades. <b>W.no: 1.4583,1.4435,1.4436,1.4404, 1.4406, 1.4408,1.4401,1.4571,1.4580,1.4406</b>
CEWELD 317L Tig	9606-1: FM5 Sect IX QW-432: F-No. 6 14343-A: W 18 15 3 L A 5.9: ER 317L	T > 550 MPa Y > 350 MPa E > 25% I ~ 65J (20 °C)	C < 0,03 Mn 1,0 - 2,5 Si 0,3 - 0,65 Cr 18,5 - 20,0 Ni 13 - 15 Mo 3,0 - 4,0	<b>317L Tig is a solid wire rod for TIG</b> , suitable to weld <b>19Cr/13Ni/3.5Mo</b> austenitic stainless steels type 317L. The increased Mo content compared to grade 316L assures increased resistance to pitting and crevice corrosion. Also suitable for the welding of 316, 316L and 316LN grades, when it is necessary to provide better pitting corrosion resistance. Suitable for service temperatures <b>from -60 °C to +300 °C</b> . <b>W.no: 1.4439, 1.4429, 1.4438, 1.4583, X2CrNiMoN 17 13 5, X2CrNiMoN 17 13 3, X2CrNiMo 18 15 4, X10CrNiMoNb 18 12, 317LN, (TP)316LN, 317L, non magnetic, ferrite free.</b>
CEWELD 318Si Tig	9606-1: FM5 Sect IX QW-432: F-No. 6 14343-A: W 19 12 3 Nb Si A 5.9: ER 318Si	T > 550 MPa Y > 350 MPa E > 25% I ~ 100J (20 °C) I ~ 70J (-60 °C)	C < 0,08 Mn 1,0 - 2,5 Si 0,65 - 1,2 Cr 18,0 - 20,0 Ni 11 - 14 Mo 2,5 - 3,0 Nb < 10xC -1,0	<b>318Si Tig is a solid wire rod for TIG</b> , suitable to weld <b>19Cr/12Ni/3Mo</b> stabilized Ti grades like 1.4571 / 316Ti. Also suitable for the welding of similar non-stabilized grades 316 or 316L. 318Si is suitable for service <b>temperatures from -60 °C to +400 °C</b> and has high resistance to intergranular corrosion. <b>W.no: 1.4571/ X6CrNiMoTi17-12-2, 1.4580/ X6CrNiMoNb17-12-2, 1.4401/ X5CrNiMo17-12-2, 1.4581/ GX5CrNiMoNb19-11-2, 1.4437/ GX6CrNiMo18-12, 1.4583/ X10CrNiMoNb18-12, 1.4436/ X3CrNiMo17-13-3, AISI 316L, 316Ti, 316Cb</b>
CEWELD 320 Tig	9606-1: FM5 Sect IX QW-432: F-No. 6 14343-B: W 320 A 5.9: ER 320LR	T > 550 MPa Y > 320 MPa E > 25% I ~ 80J (20 °C) I ~ 40J (-196 °C)	C < 0,07 Mn < 2,5 Si < 0,6 Cr 19 - 21 Ni 32- 36 Mo 2,0 - 3,0 Cu 3,0 - 4,0 Nb 8xC-1,0	<b>320 Tig is a solid wire rod for TIG</b> designed <b>specifically to withstand sulfuric acid</b> . Its nickel, chromium, molybdenum and copper levels all provide <b>excellent general corrosion resistance</b> . Restricted carbon plus niobium stabilization permits welded fabrications to be used in corrosive environments, normally without post-weld heat treatment. <b>At 33% nickel</b> , Alloy 320 has practical immunity to chloride stress corrosion cracking. This alloy is often chosen to <b>solve SCC problems</b> , which may occur with 316L stainless steel.
CEWELD 347Si Tig	9606-1: FM5 Sect IX QW-432: F-No. 6 14343-A: W 19 9 Nb Si A 5.9: ER 347Si	T > 550 MPa Y > 350 MPa E > 25% I ~ 80J (20 °C) I ~ 40J (196 °C)	C < 0,08 Mn 1,0 - 2,5 Si 0,65 - 1,0 Cr 19 - 21,5 Ni 9 - 11 Mo < 0,75 Nb < 10xC- 1,0	<b>347Si Tig is a solid wire rod for TIG</b> with <b>higher Si</b> content than 347 Tig, suitable to weld <b>18Cr/10Ni</b> stabilized with Ti or Nb austenitic stainless steel grades 321 and 347. Also suitable for welding similar unstabilized grades 304 or 304L. <b>347Si Tig</b> has <b>high resistance to intergranular corrosion</b> . <b>W.no: 1.4550/ X6CrNiNb18-10, 1.4541/ X6CrNiTi18-10, 1.4552/ GX5CrNiNb19-11,1.4301/ X5CrNi18-10,1.4312/ GX10CrNi18-8, 1.4546/ X5CrNiNb18-10, 1.4311/ X2CrNi18-10, 1.4306/ X2CrNi19-11 AISI 347, 321, 302, 304, 304L, 304LN, ASTM A296 Gr. CF 8 C, A157 Gr. C9, A320 Gr. B8C or D</b>

## SOLID WIRE

TYPE	EN -ISO and ASME -AWS	MECHANICAL PROPERTIES	ANALYSIS	APPLICATION
CEWELD 2209 Duplex Tig	9606-1: FM5 Sect IX QW-432: F-No. 6 14343-A: W 22 9 3 N L A 5.9: ER 2209	T > 550 MPa Y > 450 MPa E > 20% I ~ 40J (-60 °C)	C < 0,03 Mn 0,5 - 2,0 Si < 0,9 Cr 21,5 - 23,5 Ni 7,5 - 9,5 Mo 2,5 - 3,5 N 0,08 - 0,2 Cu < 1,5	<b>2209 Duplex Tig</b> is a <b>solid wire rod for TIG</b> , suitable for welding <b>duplex stainless steels</b> grades 2205 and 2304. Weld metal exhibits corrosion resistance similar to grade 904L in most applications. <b>2209 Duplex Tig</b> is also suitable to weld grade 2205 or grade 2304 to mild steel. <b>W.no: 1.4162, 1.4462, X2CrNiMoN 22 5 3, 1.4362, X2CrNiN 23 4, 1.4463, 1.4460, 1.4583</b>
CEWELD 2594 Tig Super Duplex	9606-1: FM5 Sect IX QW-432: F-No. 6 14343-A: W 25 9 4 N L A 5.9: ER 2594	T > 620 MPa Y > 550 MPa E > 28% I ~ 55J (-40 °C)	C < 0,03 Mn < 2,5 Si < 1,0 Cr 24 - 27 Ni 8,0 - 10,5 Mo 2,5 - 4,5 W < 1,0 N 0,2 - 0,3 Cu < 1,5	<b>2594 Tig Super Duplex</b> is a solid wire for <b>TIG welding</b> the so called Super Duplex types of stainless steels. Used for pipe work and general fabrication in the offshore oil and gas and chemical process industries for welding SAF 2507, ASTM S32760 (ZERON 100), S32550 and S31260. Also suitable for cladding on standard steels. 2507 grade is characterized by excellent resistance to stress corrosion in chloride-bearing environments and excellent resistance to pitting and crevice corrosion. <b>UNS S32550 :UR 52 N, Ferralium 255, UNS S32520 :UR 52 N+, UNS S32750 :SAF 2507, UR 47 N+, UNS S32760 :ZERON 100, UNS 32760, UR 76 N, SM22Cr, SAF 2507, ASTM S32760 (ZERON 100), S32550 and S31260</b>
CEWELD 904L Tig	9606-1: FM5 Sect IX QW-432: F-No. 6 14343-A: W 20 25 5 Cu L A 5.9: ER 385	T > 510 MPa Y > 320 MPa E > 25% I ~ 55J (-40 °C)	C < 0,025 Mn 1,0 - 2,5 Si < 0,5 Cr 19 - 21,5 Ni 24,0 - 26,0 Mo 4,2 - 5,2 Cu 1,2 - 2,0	<b>904L Tig</b> is used for <b>Tig-welding</b> materials of similar chemical composition which are used for fabrication of equipment and vessels for handling of sulfuric acid and many chloride containing media. This filler metal may also find applications for joining Type 317L material where improved corrosion resistance in specific media is needed. In order to reduce the tendency for fissuring and hot cracking, the low melting constituents such as carbon, silicon, and phosphorus are controlled to lower levels in this alloy. <b>W.no: 1.4500, 1.4505, 1.4506, 1.4519, 1.4531, 1.4536, 1.4539, 1.4573, 1.4585, 1.4586</b>
CEWELD 25-35Nb Tig	9606-1: FM5 Sect IX QW-432: F-No. 6 14343-A: W Z 25 35Nb A 5.9: --	T > 600 MPa Y > 400 MPa E > 8 %	C 0,3– 0,5 Mn ~ 1,7 Si < 1,1 Cr 25 - 27 Ni 34 - 36 Nb 1,2 - 1,5 Ti < 0,15	<b>25-35Nb</b> is <b>solid wire for TIG welding</b> of heat resistant stainless steel with similar composition and high carbon content. <b>W.no: 1.4852 GX40NiCrSiNb35-25 Alloy HP10Cb Paralloxy CR39W Lloyds T57 Centralloy H101</b>
CEWELD ER 630 Tig (17-4 PH)	9606-1: FM5 Sect IX QW-432: F-No. 6 14343-B: W 630 A 5.9: ER 630	T > 930 MPa Y > 725 MPa E > 5%	C < 0,05 Mn 0,25– 0,75 Si < 0,75 Cr 16 - 16,75 Ni 4 - 5 Mo < 0,75 Cu 3,25 - 4,0 Nb 0,15 - 0,3	<b>ER 630</b> is a <b>solid wire for TIG welding</b> , precipitation hardening stainless steel used for welding materials of similar chemical composition such as <b>17-4</b> and <b>17-7</b> .
<b>12. GMA/GTA (MIG/TIG) WIRE AND ROD FOR NICKEL BASED ALLOYS</b>				
CEWELD NiCro 600	9606-1: FM6 Sect IX QW-432: F-No. 43 18274: S Ni 6082 (NiCr20Mn3Nb) A 5.14: ER NiCr-3	T > 650 MPa Y > 400 MPa E > 35 % I ~ 150J (20 °C) I ~ 60J (-196 °C)	C < 0,1 Mn 2,5 - 3,5 Fe < 3,0 Si < 0,5 Cu < 0,5 Ni > 67,0 Ti < 0,7 Cr 18,0 - 22,0 Nb 2,0 - 3,0	<b>Nicro 600</b> filler metal is <b>used for welding nickel-chromium-iron (Inconel 600, 601 and 690) alloys</b> to themselves, and for dissimilar welding between nickel-chromium-iron (Monel, Inconel and Incoloy) alloys and steels or stainless steels. The applications include surfacing as well as clad-side welding. <b>Alloy type: Inconel 600, 2.4816, 1.4876, 2.4817, 2.4851, 1.6901, NiCr15Fe, X10Ni-CrAlTi 32 20, LC-NiCr15Fe, NiCr23Fe, X3CrNiN 18 10, alloy 600/B168, alloy 800 / 800H(T), N 10665, N 06601, kiln tyre, difficult to Weld steels, cock wheel</b>
CEWELD NiCro 601	9606-1: FM6 Sect IX QW-432: F-No. 43 18274: S Ni 6601 (NiCr23Fe15Al) A 5.14: ER NiCrFe-11	T > 650 MPa E > 42 % I ~ 60J (20 °C)	C < 0,1 Mn < 1,0 Fe < 20,0 Si < 0,5 Cu < 1,0 Ni 58,0 - 63,0 Al 1,0 - 1,7 Cr 21,0 - 25,0	<b>Nicro 601</b> filler metal is used for severe <b>applications where the exposure temperature can exceed 1150 °C</b> Excellent resistance against corrosion and oxidation and suitable for applications when exposed to hydrogen sulfide or sulfur dioxide. The nominal composition (wt.-%) of filler metal of this classification is: <b>61 Ni, 23 Cr, 14 Fe, and 1.4 Al.</b>
CEWELD NiCro 602 CA	9606-1: FM6 Sect IX QW-432: F-No. 43 18274: S Ni 6025 (NiCr25Fe10AlY) A 5.14: ER NiCrFe-12	T > 650 MPa Y > 300 MPa E > 25 % I > 50 J (20 °C)	C 0,15 - 0,25 Mn < 0,5 Fe 8,0 - 11,0 Si < 0,5 Cu < 0,1 Ni > 59,0 Al 1,8 - 2,4 Ti 0,1 - 0,2 Cr 24 - 26	<b>NiCro 602</b> filler metal is used for <b>welding similar alloys that have to resist extreme high temperature and for cladding steels or stainless steels</b> to obtain a high temperature resistant surface against oxidation. Cladding against high temperature, radiant heater tubes, furnace rolls, muffles in bright annealing furnaces (H2 atmosphere), rotary kilns, pipe hangers, waste gas components, hydrogen production, methanol and ammonia synthesis, <b>2.4633, 2.4649, NiCr25FeAlY, Nicrofer 6025 HT, Alloy 602CA, UNS N06025</b>

TYPE	EN -ISO and ASME -AWS	MECHANICAL PROPERTIES	ANALYSIS	APPLICATION
CEWELD NiCro 625  CEWELD NiCro 625 Tig	9606-1: FM6 Sect IX QW-432: F-No. 43 18274: S Ni 6625 (NiCr22Mo9Nb) A 5.14: ER NiCrMo-3	T > 750 MPa Y > 460 MPa E > 32 % I > 110J (20 °C) I ~ 70J (-196 °C)	C < 0,1 Mn < 1,0 Fe < 5,0 Si < 0,5 Cu < 0,5 Ni > 58 Al < 0,4 Ti < 0,4 Cr 20 - 23 Nb 3,0 - 4,2 Mo 8,0 - 10	<b>Nicro 625</b> is developed for welding and cladding nickel-based alloys such as alloy 625 or similar materials. This alloy can also be used for welding dissimilar nickel-based alloys to each other, to alloyed steels or to stainless steels and for joining 6% molybdenum super austenitic steels. <b>NiCr 22 Mo 9 Nb (2.4856), NiCr 22 Mo 6 Cu (2.4618), NiCr 22 Mo 7 Cu (2.4619).</b>
CEWELD NiCro 718  CEWELD NiCro 718 Tig	9606-1: FM6 Sect IX QW-432: F-No. 43 18274: S Ni 7718 (NiFe19Cr19Nb5Mo3) A 5.14: ER NiFeCr-2	T > 800 MPa Y > 530 MPa E > 28 %	C < 0,08 Mn < 0,3 Fe < 24 Si < 0,3 Cu < 0,3 Ni 50 - 55 Al 0,2 - 0,8 Ti 0,7 - 1,1 Cr 17 - 21 Nb 4,8 - 5,5 Mo 2,8 - 3,3	<b>Nicro 718</b> is used in a wide range of applications such as components for liquid fueled rockets, rings, casings and various formed sheet metal parts for aircraft and land-based gas turbine engines, and cryogenic tankage. It is also used for fasteners and instrumentation parts. 718 filler metal can be also used for cladding and overlay of parts in the oil and gas industry. <b>Inconel 718(2.4668), 706 and X-750 (X750)</b>
CEWELD NiCro 52  CEWELD NiCro 52 Tig	9606-1: FM6 Sect IX QW-432: F-No. 43 18274: S Ni6052 (NiCr30Fe9) A 5.14: ER NiCrFe-7	T > 580 MPa E > 30 % HB 150-240	C < 0,04 Mn < 1,0 Fe 7,0 - 11 Si < 0,5 Cu < 0,3 Ni > 54 Co - Al < 1,1 Ti < 1,0 Cr 28 - 31,5 Nb < 0,5 Mo < 0,5	<b>NiCro 52</b> is used for welding nickel-chromium-iron (Inconel 690) alloys to themselves, and for dissimilar welding between nickel-chromium-iron alloys and steels or stainless steels. The applications include surfacing as well as clad-side welding. <b>Interpass temperature of 150 °C should be respected.</b> <b>Alloy type:</b> <b>Inconel 690, VDM Alloy 690, Nicrofer 6030 N, FM 52.</b>
CEWELD NiCro 52M Tig	9606-1: FM6 Sect IX QW-432 : F-No. 43 18274: S Ni6054 (NiCr9Fe9) A 5.14: ER NiCrFe-7A	T > 580 MPa E > 30 % HB 150-240	C < 0,04 Mn < 1,0 Fe 7,0 - 11 Si < 0,5 Cu < 0,3 Ni > 52 Co < 0,12 Al < 1,1 Ti < 1,0 Cr 28 - 31,5 Nb < 0,5 Mo < 0,5	<b>NiCro 52M Tig</b> is used for welding nickel-chromium-iron (Inconel 690) alloys to themselves, and for dissimilar welding between nickel-chromium-iron alloys and steels or stainless steels. The applications include surfacing as well as clad-side welding. <b>Interpass temperature of 150°C should be respected.</b> <b>Alloy type:</b> <b>Inconel 690, VDM Alloy 690, Nicrofer 6030 N, FM 52.</b>
CEWELD NiCro 72M  CEWELD NiCro 72M Tig	9606-1: FM6 Sect IX QW-432: F-No. 43 18274: S Ni 6073 (NiCr38AlNbTi) A 5.14: ER NiCr-7	T > 690 MPa E > 30%	C < 0,03 Mn < 0,5 Fe < 1,0 Si < 0,3 Cu < 0,3 Ni > 63 Co < 1,0 Al 0,75 - 1,2 Ti 0,25 - 0,75 Cr 36 - 39 Nb 0,25 - 1,0	<b>NiCro 72M</b> is used for the overlay cladding of ferrous materials used in high temperature applications, and the welding of nickel-chromium-iron alloy. <b>Alloy type:</b> <b>ASTM B163, B166, B167, B168 with UNS N06690, IN657, Inco 671/800H</b>
CEWELD NiCro 92 Tig	9606-1: FM6 Sect IX QW-432: F-No. 43 18274: S Ni 7092 (NiCr15Ti3Mn) A 5.14: ER NiCrFe-6	T > 550 MPa E > 30 %	C < 0,08 Mn < 2,0-2,7 Fe < 8,0 Si < 0,35 Cu < 0,5 Ni +Co > 67 Ti 2,5-3,5 Cr 14,0-17,0	<b>NiCro 92 Tig</b> is used for the overlay cladding in high temperature applications and for dissimilar welding between Incoloy, Inconel, Monel, Nickel 200, stainless steels and Iron alloys. The high Titanium concentration provides excellent porosity resistance in field applications



## SOLID WIRE

TYPE	EN -ISO and ASME -AWS	MECHANICAL PROPERTIES	ANALYSIS	APPLICATION
CEWELD NiCro FM 53MD Tig	9606-1: FM6 Sect IX QW-432: F-No. ~43 18274: S Ni 6693 (NiCr29Fe4Al3) A 5.14: ER NiCrFeAl-1	T > 760 MPa E > 45 %	C < 0,15 Mn < 1,0 Fe 2,5 - 6,0 Si < 0,5 Cu < 0,5 Ni > 50 Al 2,5 - 4,0 Ti < 1,0 Cr 27 - 31 Nb 0,5 - 2,5	<b>Nicro FM 53MD Tig</b> is used for the <b>gas-tungsten-arc</b> and gas-metal-arc welding of <b>INCONEL alloy 693</b> , and the overlaying of carbon steels and stainless steels to provide a <b>nickel-chromium-aluminum alloy corrosion resistant surface</b> . The high chromium and aluminum lev-els provide excellent resistance to metal dusting in chemical and pet-rochemical applications. The product also provides excellent resistance to carburization, sulfidation, and other high temperature corrosion forms. <b>Alloy type: Inconel Alloy 693</b>
CEWELD NiTi3  CEWELD NiTi3 Tig	9606-1: FM6 Sect IX QW-432: F-No. 41 18274: S Ni 2061 (NiTi3) A 5.14: ER Ni-1	T > 414 MPa Y > 200 MPa E > 30 % I > 100 J (20 °C)	C < 0,15 Mn < 1,0 Fe < 1,0 Si < 0,7 Cu < 0,2 Ni > 92 Al < 1,5 Ti 2,0 - 3,5	<b>NiTi3</b> is developed for <b>welding and cladding Nickel 200</b> and Nickel 201. This alloy is also suited for surfacing of steel. <b>Dissimilar welding applications</b> of filler metal <b>NiTi3</b> include joining Nickel 200 and 201 to stainless steels, copper-nickel alloys, and Monel alloys. It is also used for joining Monel alloys and copper-nickel alloys to carbon steels, and for joining copper-nickel alloys to Inconel en Incoloy alloys. <b>Type of alloys : Nickel 200 - Nickel 201, UNS Nr (unified numbering system): N 02200 - N 02201. DIN 17 742: Ni 99.6; Ni 99.2; LC-Ni99.6; LC-Ni99 Mat n°: 2.4060 - 2.4061 - 2.4066- 2.4068</b>
CEWELD NiCu30Mn  CEWELD NiCu30Mn Tig	9606-1: FM6 Sect IX QW-432: F-No. 42 18274: S Ni 4060 (NiCu30Mn3Ti) A 5.14: ER NiCu-7	T > 450 MPa Y > 300 MPa E > 30 % I > 70 J (20 °C)	C < 0,15 Mn 2,0 - 4,0 Fe < 2,5 Si < 1,2 Cu 28 - 32 Ni > 62 Al < 1,0 Ti 0,3 - 1,0	<b>NiCu30Mn</b> weld metal has <b>properties similar to "Monel 400"</b> . It has <b>good strength and resists corrosion</b> in many media, including sea water, salts and reducing acids. The weld metal is not age hardenable and when used to join Monel K-500 it has lower strength than the base metal. Shipbuilding, seawater evaporation plants, tubes, pump building, offshore etc. <b>NiCu30Mn is suitable for dissimilar welding between Nickel 200-201, stainless steel, carbon steel, Inconel and Incoloy alloys, Nickel Copper and Copper nickel alloys.</b>
CEWELD NiCrCo 617  CEWELD NiCrCo 617 Tig	9606-1: FM6 Sect IX QW-432: F-No. 43 18274: S Ni 6617 (NiCr22Co12Mo9) A 5.14: ER NiCrCoMo-1	T > 760 MPa Y > 480 MPa E > 32 % I > 120 J (20 °C)	C 0,5 - 0,15 Mn < 1,0 Fe < 3,0 Si < 1,0 Cu < 0,5 Ni > 44 Co 10 - 15 Al 0,8 - 1,5 Ti < 0,6 Cr 20 - 24 Mo 8,0 - 10 W < 0,5	<b>NiCrCo 617</b> is a <b>high temperature alloy</b> which is used for welding of <b>nickel-chromium-cobalt-molybdenum</b> alloys (UNS Number N06617). This filler metal can also be used for overlay cladding where similar alloy is required such as gasturbines and ethylene equipment. <b>Inconel alloys 600 and 601, Incoloy alloys 800 HT and 802 and cast alloys such as HK-40, HP and HP-45 Modified. UNS Number N06617, 2.4663, 1.4952, 1.4958, 1.4959, NiCr21Co12Mo, X6CrNiNbN 25 20, X5NiCrAlTi 31 20, X8NiCrAlTi 32 21, Alloy 617, N08810, N0881</b>
CEWELD NiCrMo 59  CEWELD NiCrMo 59 Tig	9606-1: FM6 Sect IX QW-432: F-No. 43 18274: S Ni 6059 (NiCr23Mo16) A 5.14: ER NiCrMo-13	T > 720 MPa Y > 450 MPa E > 32 % I > 90 J (20 °C)	C < 0,01 Mn < 0,5 Fe < 1,5 Si < 0,1 Ni > 56 Co < 0,3 Al 0,1 - 0,4 Ti < 0,5 Cr 22 - 24 Mo 15 - 16,5	<b>NiCrMo 59</b> provides strong, <b>tough Nb-free</b> weld metal for dissimilar welds in super austenitic and Superduplex stainless steels or combinations of these with nickel base alloys. Some authorities do not allow or have discontinued use of 625 type consumables for such applications, where deleterious Nb-rich precipitates may form in diluted or partially mixed regions around the fusion boundary. <b>Duplex, Super-Duplex and Super-Austenitic stainless Steels, Nickel Alloys such as UNS N06059 and N06022, INCONEL Alloy C4, C-276, and INCONEL Alloys 622, C22, 625, and 686 CPT, Alloy 31, Alloy 59, 1.4562, 2.4605, 2.4602, 2.4610, 2.4819, NiCr21Mo14W, NiCr23Mo16Al, NiMo16Cr15Ti, NiMo16Cr15W</b>
CEWELD NiCrMo 622  CEWELD NiCrMo 622 Tig	9606-1: FM6 Sect IX QW-432: F-No. 43 18274: S Ni 6022 (NiCr21Mo13Fe4W3) A 5.14: ER NiCrMo-10	T > 690 MPa Y > 310 MPa E > 30 % I > 70 J (20 °C)	C < 0,01 Mn < 0,5 Fe 2,0 - 6,0 Si < 0,08 Cu < 0,5 Ni > 49 Co < 2,5 Cr 20 - 22,5 Mo 12,5 - 14,5	<b>NiCrMo 622</b> is used for welding of <b>nickel-chromium-molybdenum alloys</b> as well as for overlay cladding on carbon, low alloy, or stainless steels. They are also used for <b>dissimilar joints between nickel-chromium-molybdenum alloys and stainless, carbon, or low alloyed steels</b> . Also recommended for joining Molybdenum-containing stainless steels, low alloyed steels and dissimilar welding between earlier mentioned type of steels. <b>ASTM, F574, B619, B622 and B626 - All of which have UNS Number N06022. UNS: W86022 Welding of Inconel Alloys 622 and 625, Alloy 25-6Mo, Incoloy 825 Hastelloy C4, C22, C-276 and Inconel 625, 2.4611</b>
CEWELD Alloy 230 Tig	9606-1: FM6 Sect IX QW-432: F-No. 43 18274: S Ni 6231 (NiCr22W14Mo2) A 5.14: ER NiCrWMo-1	T > 785 MPa Y > 490 MPa E > 48 %	C 0,05 - 0,15 Mn 0,3 - 1,0 Fe < 3,0 Si 0,25 - 0,75 Cu < 0,5 Ni > 48 Co < 5,0 Al 0,2 - 0,5 Cr 20 - 24 Mo 1,0 - 3,0 W 13 - 15	<b>Alloy 230 Tig</b> combines properties which make it ideally suited for a wide variety of component applications in the aerospace and power industries. It is used for combustion cans, transition ducts, flame holders, thermocouple sheaths, and other important gas turbine components. In the chemical process industry, <b>Alloy 230 is used for catalyst grid</b> supports in ammonia burners, high-strength thermocouple protection tubes, high-temperature heat exchangers, ducts, high-temperature bellows, and various other key process internals. In the industrial heating industry, applications for Alloy 230 include furnace retorts, chains and fixtures, burner flame shrouds, recuperator internals, dampers, nitriding furnace internals, heat-treating baskets, grates, trays, sparger tubes, thermocouple protection tubes, cyclone internals, and many more.

TYPE	EN -ISO and ASME -AWS	MECHANICAL PROPERTIES	ANALYSIS	APPLICATION
CEWELD Alloy 33	9606-1: FM6 Sect IX QW-432: F-No. 45 18274: S Z 33 32 1 Cu N L A 5.9: ER33-31 W.no: 1.4591 X 1CrNiMoCuN33-32-1	T > 730 MPa Y > 400 MPa E > 25 %	C < 0,015 Mn < 2,0 Fe Rest Si < 0,5 Cu 0,3 - 1,2 Ni 30 - 33 Co < 5,0 Al 0,2- 0,5 Cr 31 - 30 Mo 0,5 - 2,0 N 0,35 - 0,6	<b>Alloy 33</b> is a <b>high-chromium austenitic alloy</b> . This alloy combines ease of fabrication with outstanding resistance to highly oxidizing media.
CEWELD Alloy 740H CEWELD Alloy 740H Tig	9606-1: FM6 Sect IX QW-432: F-No. 45 A 5.14: ~ ER NiCrCo-1 UNS N07740	T > 1100 MPa Y > 700 MPa E > 25 %	C 0,005 - 0,08 Mn < 1,0 Fe < 3,0 Si < 1,0 Cu < 0,5 Ni > 30 Co 20 - 22 Al 0,5-2,5 Cr 23,5 - 25,5 Nb 0,5-2,5 Mo < 2,0	<b>Alloy 740H</b> is a <b>nickel-base, age hardenable</b> by the precipitation of a gamma prime second phase. The alloy is intended for service in high temperature applications for the ultra-supercritical power boilers and diesel engine exhaust valve markets. The Alloy has excellent resistance to coal ash corrosion.
CEWELD Alloy 825 CEWELD Alloy 825 Tig	9606-1: FM6 Sect IX QW-432: F-No. 45 18274: S Ni8065 (NiFe30Cr21Mo3) A 5.14: ER NiFeCr-1	T > 630 MPa Y > 425 MPa E > 20 % I > 70 J (-196 °C)	C < 0,5 Mn < 1,0 Fe > 22 Si < 0,5 Cu 1,5 - 3,0 Ni 38 - 46 Al < 0,2 Ti 0,6 - 1,2 Cr 19,5 - 23,5 Mo 2,5 - 3,5	<b>Alloy 825</b> is a <b>nickel-base</b> with an excellent weldability with fully austenitic weld metal with high resistance against stress corrosion cracking and pitting in media containing chloride ions. Good corrosion resistance against reducing acids due to the combination of Ni, Mo and Cu. Sufficient resistance against oxidizing acids. The weld metal is corrosion resistant in sea water. <b>G-X7NiCrMoCuNb 25 20, X1NiCrMoCuN25 20 6, X1NiCrMoCuN25 20 5, NiCr21Mo, X1NiCrMoCu 31 27 4, N08926, N08904, ALLOY 825, N08028, UNS N08825 W.Nr: 1.4500, 1.4529, 1.4539 (904L), 2.4858, 1.4563, 1.4465, 1.4577 (310Mo), 1.4133, 1.4500, 1.4503, 1.4505, 1.4506, 1.4531, 1.4536, 1.4585, 1.4586</b>
CEWELD Alloy B3	9606-1: FM6 Sect IX QW-432: F-No. 44 18274: S Ni 1067 (NiMo30Cr) A 5.14: ER NiMo-10	T > 824 MPa Y > 544 MPa E > 40 % I > 195J (20 °C)	C < 0,01 Mn < 3,0 Fe 1,0 - 3,0 Si < 0,1 Cu < 0,2 Ni > 52,0 Co < 3,0 Al < 0,5 Cr 1,0 - 3,0 Nb < 0,2 Mo 27- 32 W < 3,0	<b>Alloy B3</b> is a <b>nickel-base alloy with excellent resistance tot hydrochloride acid</b> at all concentrations and temperatures. It also withstands hydrogen chloride, sulfuric, acetic, hydrofluoric and phosphoric acids. The alloy has improved thermal stability, fabric ability and stress corrosion cracking resistance. <b>Hastelloy B2, Hastelloy B3, dissimilar welding Hasteloy to nickel- of iron-based corrosion alloys, for weld overlay cladding.</b>
CEWELD Alloy C-2000 CEWELD Alloy C-2000 Tig	9606-1: FM6 Sect IX QW-432: F-No. 43 18274: S Ni 6200 (NiCr23Mo16Cu2) A 5.14: ER NiCrMo-17	T > 690 MPa Y > 280 MPa E > 45%	C < 0,01 Mn < 0,5 Fe < 3,0 Si < 0,08 Cu 1,3 - 1,9 Ni > 52 Co < 2,0 Cr 22 - 24 Mo 15 - 17	<b>Alloy C-2000</b> is like other nickel alloys, it is ductile, easy to form and weld, and possesses exceptional <b>resistance to stress corrosion cracking in chloride-bearing solutions</b> (a form of degradation to which the austenitic stainless steels are prone). It is able to withstand a wide range of oxidizing and non-oxidizing chemicals, and exhibits outstanding resistance to pitting and crevice attack in the presence of chlorides and other halides.
CEWELD 35-45Nb CEWELD 35-45Nb Tig	9606-1: FM6 Sect IX QW-432: F-No. 43 14343: W Z 35 45 Nb 18274: S Ni Z (NiCr36Fe15Nb0,8) A 5.9: -	T > 660 MPa Y > 460 MPa E > 8 %	C 0,3 - 0,5 Mn 0,7 - 1,1 Fe Rem. Si ~ 1,4 Nb 1,0 - 1,2 Ni 44 - 46 Ti ~ 0,09 Cr 34 - 38	<b>35-45Nb</b> kann als Draht oder Stab zum Verbindungs- und Auftragsschweißen von gleichartigen und ähnlichen hitzebeständigem Stahlguss (Schleuderguss, Formguss) wie GX-45NiCrNbSiTi45 35 verwendet werden. Das Schweißgut kann in schwefelarmen und aufkohlenden Atmosphären bis zu 1180°C eingesetzt werden. <b>Das Haupteinsatzgebiet:</b> Schleuder- und Formgussteile, Pyrolyseöfen aus GX-45NiCrNbSiTi 45 35.
CEWELD Alloy C-276 CEWELD Alloy C-276 Tig	9606-1: FM6 Sect IX QW-432: F-No. 43 18274: S Ni 6276 (NiCr15Mo16Fe6W4) A 5.14: ER NiCrMo-4	T > 740 MPa Y > 470 MPa E > 32 % I > 100J (20 °C)	C < 0,02 Mn < 1,0 Fe 4,0 - 7,0 Si < 0,08 Cu < 0,5 Ni > 50 Co < 2,5 Al < 0,5 Cr 14,5 - 16,5 Mo 15 - 17 W 3,0 - 4,5	<b>Alloy C276</b> is used for <b>welding materials of similar composition</b> . This low carbon nickel-chromium-molybdenum filler metal can also be used for dissimilar welding between nickel base alloys and stainless steels, as well as for surfacing and cladding on low alloyed steels. <b>W.no: 2.4819, NiMo16Cr15W, alloy C4 ,N10276</b>

## SOLID WIRE

TYPE	EN -ISO and ASME -AWS	MECHANICAL PROPERTIES	ANALYSIS	APPLICATION
CEWELD Alloy X	9606-1: FM6 Sect IX QW-432: F-No. 43 18274:	T > 660 MPa E > 30% I > 100 J (20 °C)	C 0,05 - 0,15 Mn < 2,0 Fe 17 - 20 Si < 1,0 Cu < 0,5 Ni > 44 Co 0,5 - 2,5 Cr 20,5 - 23 Mo 8,0 - 10 W 0,2 - 1,0	<b>Alloy X</b> is a <b>nickel-chromium-iron-molybdenum</b> alloy that possesses an exceptional combination of oxidation resistance, fabric ability and high-temperature strength. It has also been found to be exceptionally resistant to stress-corrosion cracking in petrochemical applications. X alloy exhibits good ductility after prolonged exposure at <b>temperatures of 1200, 1400, 1600 °F (650, 760 and 870 °C)</b> for 16,000 hours. Suitable for joining and <b>cladding Nickel Alloys</b> , stainless steel, carbon steel and low alloyed steels. UNS: N06002
CEWELD Alloy X Tig	S Ni 6002 (NiCr21Fe18Mo9) A 5.14: ER NiCrMo-2			
<b>13. GTA (TIG) WIRE AND ROD FOR STELLITE (COBALT ALLOYS)</b>				
CEWELD DUR 1 Tig	Sect IX QW-432: F-No. 71 14700: S Co3 8555: WSG 20-G0-55-CSTZ A 5.21: ER CoCr-C	HRc 45-60	C ~ 2,4 Mn ~ 0,4 Si ~ 0,7 W ~ 11,0 Co Rest Cr ~ 30,0 Fe < 3,0	<b>DUR 1 Tig</b> is a cobalt-based alloy rod with high abrasion and corrosion resistance. <b>Stellite 1 alloy for cladding, pump sleeves, expeller screws, impellers, plastic recycling, mixer blades for rubber, valves, seats etc.</b>
CEWELD DUR 6 Tig	Sect IX QW-432: F-No. 71 14700: S Co2 8555: WSG 20-G0-40-CSTZ A 5.21: ER CoCr-A	HRc 35-50	C ~ 1,1 Mn ~ 0,6 Si ~ 1,0 W ~ 4,5 Co Rest Cr ~ 28,0 Fe < 5,0	<b>DUR 6 Tig</b> is a cobalt-based alloy rod against abrasion, thermo-shock and corrosion combined with high temperatures. The weld deposit can be machined with tungsten-carbide tool tips and by grinding. The hardness of the weld deposit will decrease with 16% at 300°C and about 30% at 600 °C. The weld deposit is high heat resistant up to <b>900 °C</b> . <b>DUR 6 Tig</b> offers a low coefficient of friction of 0.12 and exceptional resistance to galling. It has cavitation-erosion resistance ten times that of 304 stainless steel, <b>DUR 6 Tig</b> can be used to protect bearing surfaces in non-lubricating conditions due to its resistance to metal-to-metal wear. <b>Stellite 6 alloy for, steam-valves, high temperature liquid pumps, hot cutting tools, exhaust valves and seats.</b>
CEWELD DUR 12 Tig	Sect IX QW-432: F-No. 71 14700: S Co3 8555: WSG 20-G0-50-CSTZ A 5.21: ER CoCr-B	HRc 45-50	C ~ 1,4 Mn ~ 0,1 Si ~ 0,8 W ~ 8,0 Co Rest Cr ~ 29,0 Fe < 2,5	<b>DUR 12 Tig</b> is a Cobalt-based alloy rod against abrasion, thermo-shock and corrosion combined with high temperatures. The weld deposit can be machined with tungsten tool tips and by grinding. The hardness of the weld deposit will decrease with 20% at 600 °C and has a nominal hardness of <b>49-53 HRc</b> at room temperature. The weld deposit is high heat resistant up to <b>900 °C</b> . <b>DUR 12</b> offers a low coefficient of friction of and exceptional resistance to galling. It has cavitation-erosion resistance ten times that of 304 stainless steel, <b>DUR 12 Tig</b> can be used to protect bearing surfaces in non-lubricating conditions due to its resistance to metal-to-metal wear. <b>Stellite 12 alloy for Hardfacing steam-valves, high temperature liquid pumps, hot cutting tools, cutting, tools for plastic, wood and paper as well as high stressed sealing's and, sliding surfaces.</b>
CEWELD DUR 21 Tig	Sect IX QW-432: F-No. 71 14700: S Co1 8555: WSG 20-G0-300-CKTZ A 5.21: ER CoCr-E	HRc 40-45	C ~ 0,3 Mn ~ 1,0 Si ~ 0,9 Co Rest Cr ~ 28,0 Fe ~ 3,0 Ni ~ 3,0 Mo ~ 5,5	<b>DUR 21 Tig</b> is a cobalt-based alloy rod with high abrasion and corrosion resistance. <b>Stellite 21 alloy for Forging tools, hot cutting and trimming tools, valve seats etc.</b>
<b>14. GMA/GTA (MAG/TIG) WIRE AND ROD FOR HARDFACING</b>				
CEWELD MA 350	Sect IX QW-432: F-No. 71 14700: S Fe2 (DIN 8555 MSG-5-GZ-350) A 5.21: ER Fe-1	HRc 30-58	C ~ 0,08 Cr ~ 5,5 Ni ~ 0,1 Mn ~ 0,5 Mo ~ 0,5 Fe Rest	<b>MA 350</b> is a <b>solid welding wire for rebuilding parts and for buffer layers before hardfacing</b> . He offers almost full hardness in the first layer and can be applied <b>without any risk of cracking</b> . Multiple layers or sandwich layers are possible before hardfacing and will help to increase the hardness (wear resistance) from the hard-faced layer.
CEWELD MA 6500 Tig	Sect IX QW-432: F-No. 71 14700: S Fe3 (DIN 8555 WSG 6-GZ-50 T)	HRc 40-55	C ~ 0,4 Cr ~ 6,0 Ni ~ 0,1 Mn ~ 0,5 Mo ~ 1,6 V ~ 1,0 Fe Rest	<b>MA 6500 Tig</b> is a <b>solid welding rod</b> for rebuilding parts. He offers almost <b>full hardness in the first layer</b> and can be applied <b>without any risk of cracking</b> . Multiple layers or sandwich layers are possible before hardfacing and will help to increase the hardness (wear resistance) from the hard-faced layer.
CEWELD MA 600 CEWELD MA 600 Tig	Sect IX QW-432: F-No. 71 14700: S Fe8 (DIN 8555 MSG-6-GZ-60-GPS) A 5.21: ER FeCr-A	HRc 50-65	C ~ 0,4 Cr ~ 10,0 Mn ~ 0,5 Mo ~ 0,02 W ~ 0,005 Nb ~ 0,005 V ~ 0,02 Fe Rest	<b>MA 600</b> is a <b>solid welding wire and rod</b> for rebuilding parts. He offers <b>outstanding abrasion resistance combined with heavy shocks</b> , despite the high hardness several layers can be applied without any risk of breaking out or chipping of. In case of sensitive base material preheating is recommended at <b>300-400 °C</b> . Old hardfacing layers should be removed, clean or grind properly before welding.

TYPE	EN -ISO and ASME -AWS	MECHANICAL PROPERTIES	ANALYSIS	APPLICATION
CEWELD MA 650	Sect IX QW-432: F-No. 71 14700: S Fe8 (DIN 8555 MSG 3-GZ-60T ) A 5.21: ER Fe-8	HRc 50-65	C ~ 0,4 Cr ~ 5,0 Ni ~ 0,1 Mn ~ 0,5 Mo ~ 1,4 W ~ 1,3 V ~ 0,3 Fe Rest	<b>MA 650</b> is a <b>solid welding wire</b> for <b>hardfacing parts that are subject to high abrasion</b> , the addition of tungsten, vanadium and molybdenum offers better cutting properties and higher hardness. <b>Hardness: 570-660 HB</b>
CEWELD MA HSS	Sect IX QW-432: F-No. 71 4700: S Fe4 (DIN 8555 MSG 4-UM-60(65W)-ST) A 5.21: ER Fe-8	HRc 55-65	C ~ 1,0 Cr ~ 4,0 Ni < 4,0 Mn < 0,3 Mo ~ 8,0 W ~ 1,8 V ~ 2,0 Fe Rest	<b>MA HSS</b> is a <b>solid wire</b> for <b>hardfacing alloy</b> based on a High Speed Steel (HSS) weld deposit. Extreme hard and heat resistant alloy that offers excellent cutting properties when cutting steel cables, bars, wooden bars etc. The alloy is only machinable by grinding. <b>57-62 HRc hardfacing</b> alloy for steel cutting knives, scissors, HSS, high speed tool steel, 1.3348, molds, edges and repairs on: <b>X85WDCV06-04-02; V6Mo5Cr4V2; HS 6-5-2; M2, J438B; X85WDCV06-04-02; BM2; SKH 51; R 6 M 5</b>
CEWELD MA SS 2343	Sect IX QW-432: F-No. 71 14700: S Fe3 (DIN 8555 MSG 4-UM-60(65W)-ST) A 5.21: (AISI J 438 b) H 11	HRc 50-60	C ~ 0,4 Cr ~ 5,0 Ni < 5,0 Mn ~ 0,4 Mo ~ 1,1 V ~ 0,5 Fe Rest	<b>MA SS 2343</b> is a <b>solid welding wire</b> and <b>rod</b> for <b>Hardfacing</b> and <b>rebuilding hot working tools</b> . Rebuilding and hardfacing parts that are subject to abrasion combined with higher temperatures. <b>Hot working tools</b> , high speed tool steels, HSS, aluminum press molts, dies, stamping tools, cutting tools, shear blades, cutters, knives, scissors.
CEWELD MA SS 2367	Sect IX QW-432 : F-No. 71 14700: S Fe8 W.Nr:~1.2367 A 5.21: --	HRc 40-50	C ~ 0,2 Cr ~ 6,2 Ni < 5,0 Mn ~ 0,6 Mo ~ 3,2 Fe Rest	<b>MA SS 2367</b> is a <b>solid welding wire</b> for <b>hardfacing</b> and <b>rebuilding hot working tools</b> . Rebuilding and hardfacing parts that are subject to abrasion combined with higher temperatures. <b>Hot working tools</b> , high speed tool steels, <b>HSS, aluminum press molts</b> , dies, stamping tools, cutting tools, shear blades, cutters, knives, scissors
<b>15. GMA/GTA (MAG/TIG) STAINLESS WIRE AND ROD FOR HARDFACING</b>				
CEWELD MA 617	14700: S Fe8 X35CrMo17	HRc 45-55	C ~ 0,4 Si ~ 1,0 Mn ~ 1,5 Cr ~ 16,0 Mo ~ 1,0 Ni ~ 1,0	<b>MA 617</b> is a <b>stainless welding wire</b> for <b>hard-facing</b> against abrasion combined <b>with corrosion and heavy impact loads</b> . <b>MA 617</b> offers outstanding metal to metal wear resistance combined with impact, despite the high hardness several layers can be applied without risk of chipping of. The weld deposit is temperature resistant <b>up to 500 °C</b> and hardness will remain very well at increased temperatures. <b>Scale resistant till 900 °C</b> .
CEWELD 410	9006-1: FM5 Sect IX QW-432: F-No. 6 14343-A: W Z 13	T > 450 MPa Y > 250 MPa E > 15 %	C ~ 0,02 Mn ~ 0,5 Si ~ 0,3 Cr ~ 13,0 Ni ~ 0,3 Mo ~ 0,03 Cu ~ 0,04	<b>410</b> is a <b>stainless solid welding wire and rod</b> martensitic and <b>heat-treatable</b> . It has a nominal weld metal <b>composition of 12% Chromium</b> . These weld deposits are air-hardenable that can normally be heat-treated after welding. Overlay of carbon and low-alloy steels for resistance to corrosion, erosion, or abrasion.
CEWELD 410 Tig	DIN 8556: S G-X 8 Cr 14 A 5.9: ER 410	HRc 35 nach PWHT HB 180		
CEWELD MA 4115	9606-1: FM5 Sect IX QW-432: F-No. 6 14343-A: W 17	HRc 42-47	C ~ 0,2 Si ~ 0,5 Mn ~ 0,6 Ni ~ 0,4 Cr ~ 16,5 Mo ~ 0,5 Fe Rest	<b>MA 4115</b> is a <b>stainless steel welding wire</b> for joining and cladding <b>17% Chromium alloys and cladding components</b> where heat and corrosion resistance similar to AISI 304 is required. The weld deposit can sustain working temperatures <b>up to 450 °C</b> and will offer a high hardness and wear resistance.
CEWELD MA 4115 Tig	8555: E6-200-PR A 5.9: ER 430			
<b>16. GMA/GTA (MIG/TIG) WELDING OF ALUMINIUM ALLOYS</b>				
CEWELD AI99,0	Sect IX QW-432: F-No. 21 18273: S AL 1100 / AL 99,0Cu	T ~ 85 MPa Y ~ 38 MPa E ~ 30 %	Si+Fe < 0,95 Cu 0,05 - 0,2 Mn < 0,05 Zn < 0,1 Al > 99,0	<b>AI99,0Cu</b> is a <b>pure aluminum filler metal for MIG and TIG welding</b> . Mostly pure aluminum (maximum 0,95% of alloyed elements). Applications in chemistry, electronics, construction and food industries. <b>AI99,0 Al.99,5 Al.99,7 E-Al., 99,5, 3.0205, 3.0255, 3.0275, 3.0257, EN AW 1200, EN AW 1050A, EN AW 1070A, EN AW 1350, 1060, 1070, 1080, and 3003</b>
CEWELD AI99,0 Tig	A 5.10: ER 1100			
CEWELD AI99,7	Sect IX QW-432: F-No. 21 18273: S AL 1070/AL 99,7	T ~ 80 MPa Y ~ 35 MPa E ~ 30 %	Si < 0,20 Fe < 0,25 Cu < 0,04 Mn < 0,03 Mg < 0,03 Zn < 0,04 Ti < 0,03 Al < 99,7	<b>AI99,7</b> is a <b>pure aluminum filler metal for MIG and TIG welding</b> . Mostly welding mostly pure aluminium (maximum 0,5% of alloyed elements). Applications in chemistry, electronics, construction and food industries. <b>AI99,0 Al.99,5 Al.99,7 E-Al., 99,5, 3.0205, 3.0255, 3.0275, 3.0257, EN AW 1200, EN AW 1050A, EN AW 1070A, EN AW 1350</b>
CEWELD AI99,7 Tig	A 5.10: ER 1070			

## SOLID WIRE

TYPE	EN -ISO and ASME -AWS	MECHANICAL PROPERTIES	ANALYSIS	APPLICATION
CEWELD AI99,5 Ti	Sect IX QW-432: F-No. 21 18273: S AL 1450 / AL 99,5 Ti	T ~ 80 MPa Y ~ 30 MPa E ~ 35 %	Si < 0,25 Fe < 0,40 Cu < 0,05 Mn < 0,05 Mg < 0,05 Zn < 0,07 Ti 0,1 - 0,2 Al < 99,5	<b>AI99,5 Ti is a pure aluminum filler metal for MIG welding.</b> Mostly welding mostly pure aluminium (maximum 0,5% of alloyed elements). Applications in chemistry, electronics, construction and food industries. <b>Cast aluminium special repairs, AI99,0 AI.99,5 AI.99,7 E-AI.</b>
CEWELD AI99,5 Ti Tig	A 5.10: ER 1450			
CEWELD AlSi 5	Sect IX QW-432: F-No. 23 18273: S Al 4043A / AlSi5(A)	T < 120 MPa Y ~ 60 MPa E ~ 15 %	Si 4,5 - 6,0 Fe < 0,60 Cu < 0,3 Mn < 0,15 Mg < 0,2 Zn < 0,10 Ti < 0,15 Al Rest	<b>AlSi5 is an aluminum-silicon filler metal for MIG and TIG welding.</b> Mostly welding Aluminum alloys with maximum 2% alloying elements and for aluminum alloys containing up to 7% Si. (after anodizing welding will be of a dark grey color ) <b>AlMgSi 0, AlSiMg (A), AlSi 1 MgMn, AlMg1SiCu, 3.3206, 3.3210, 3.2315, 3.3211, EN AW 6060, EN AW 6005A, EN AW 6082, EN AW 6061, EN AC 45000</b>
CEWELD AlSi 5 Tig	A 5.10: ER 4043(A)			
CEWELD AlSi 12	Sect IX QW-432: F-No. 23 18273: S Al 4047A / AlSi12(A)	T < 130 MPa Y ~ 70 MPa E ~ 13 %	Si 11,0 - 13,0 Fe < 0,60 Cu < 0,3 Mn < 0,15 Mg < 0,1 Zn < 0,2 Ti < 0,15 Al Rest	<b>AlSi12 is a aluminum silicon alloy filler metal for MIG and TIG welding.</b> AlSi12 was originally developed as a brazing alloy to take advantage of its low melting point and narrow freezing range. In addition, it has a higher silicon content than AlSi5, which provides increased fluidity and reduced shrinkage. Hot cracking is significantly reduced when using AlSi12 as a filler alloy. <b>G-AISi10Mg, G-AISi11 G-AISi12 (Cu), G-AISi7Mg, G-AISi6Cu4 , G-AISi9Mg, G-AISi9Cu3, AlMgSi0.8, AlMgSi1, 4145, 3.2581, 3.2583, 3.2381, 3.2383, 3.2373, 3.2163, 3.2371, 3.2151, B 413.0, 361.0, 359.0, 356.0, 319.0</b>
CEWELD AlSi 12 Tig	A 5.10: ER 4047(A)			
CEWELD AlMg 3	Sect IX QW-432: F-No. 22 18273: S Al 5754 / AlMg3	T < 190 MPa Y ~ 80 MPa E ~ 20 %	Si < 0,4 Fe < 0,40 Cu < 0,1 Mn < 0,5 Mg 2,6 - 3,6 Cr < 0,3 Zn < 0,2 Ti < 0,15 Al Rest	<b>AlMg 3 is a aluminum magnesium alloy filler metal for MIG and TIG welding</b> and is suitable for base metals with maximum 3% Mg. These alloys are suitable for a large range of applications in the construction sector, in general, and in the structural industry. Widely used in ship and vessel building. <b>G-AISi10Mg, G-AISi11 G-AISi12 (Cu), G-AISi7Mg, G-AISi6Cu4 , G-AISi9Mg, G-AISi9Cu3, AlMgSi0.8, AlMgSi1, 4145, 3.2581, 3.2583, 3.2381, 3.2383, 3.2373, 3.2163, 3.2371, 3.2151, B 413.0, 361.0, 359.0, 356.0, 319.0</b>
CEWELD AlMg 3 Tig	A 5.10: ER 5754			
CEWELD AlMg 4,5 Mn	Sect IX QW-432: F-No. 22 18273: S AL5183 / AlMg4,5Mn0,7(A)	T > 275 MPa Y > 125 MPa E > 16 % I ~ 30J (20 °C)	Si < 0,40 Fe < 0,40 Cu < 0,10 Mn 0,5 - 1,0 Mg 4,3 - 5,2 Cr 0,05 - 0,25 Zn < 0,25 Ti < 0,15 Al Rest	<b>AlMg 4,5 Mn is a aluminum magnesium alloy filler metal for MIG and TIG welding.</b> It is suitable for Magnesium and Manganese alloyed Aluminum with a maximum Magnesium content of 5%. This alloy shows very good mechanical properties that make it ideal for applications in shipyards, in car and railway industry and constructions of reservoirs and tanks. <b>Aluminum alloys: AlMg4,5Mn, AlMg5, AlMg2Mn0,8, AlZnMg1, AlZnMgCu0,5, AlMgSi0,5, AlMgSi1, G-AlMg10, G-AlMg5, G-AlMg3Si, G-AlMg5Si, 3.3545, 3.3547, 3.3535, 3.3555, 3.3206, 3.3210, 3.2315, 3.3211, 3.4335, EN AW 5086, EN AW 5083, EN AW 5019, EN AW 5019, EN AW 6060, EN AW 6005A, EN AW 6082, EN AW 6061, EN AW 7020, EN AC 51300, EN AC 51400</b>
CEWELD AlMg 4,5 Mn Tig	A 5.10: ER 5183			
CEWELD AlMg 4,5 MnZr	Sect IX QW-432: F-No. 22 18273: S Al5087 / AlMg4,5MnZr(A)	T > 275 MPa Y > 125 MPa E > 17%	Si < 0,25 Fe < 0,40 Cu < 0,05 Mn 0,7 - 1,1 Mg 4,5 - 5,2 Cr 0,05 - 0,25 Zn < 0,25 Zr 0,1 - 0,2 Ti < 0,15 Al Rest	<b>AlMg 4,5MnZr is a Special alloy for welding aluminum-magnesium basis alloys with maximum 5% Mg.</b> Zirconium acts as grain-refiner to improve both the bending and the corrosion resistance. Applications in the construction of ships, off-shore, storage tanks, railways and automotive industry <b>Aluminum alloys: AlMg4,5Mn, AlZnMgCu1,5, AlMg5, AlMg3, AlMg5, AlMg2Mn0,8, AlMg2,7Mn, AlZn4,5Mg1, AlZnMg4,5Mn, G-AlMg3Si, G-AlMg5Si, G-AlMg10, G-AlMgSi1, AlMgSiCu</b>
CEWELD AlMg 4,5 MnZr Tig	A 5.10: ER 5087			
CEWELD AlMg 5	Sect IX QW-432: F-No. 22 18273: S Al5356 / AlMg5Cr(A)	T > 275 MPa Y > 115 MPa E > 25 %	Si < 0,25 Fe < 0,40 Cu < 0,10 Mn 0,05 - 0,2 Mg 4,5 - 5,5 Cr 0,05 - 0,2 Zn < 0,1 Ti < 0,06 - 0,2 Al Rest	<b>AlMg 5 is a aluminum magnesium alloy filler metal for MIG and TIG welding.</b> This Magnesium alloyed Aluminum wire, thanks to its excellent corrosion resistance and its high mechanical properties is mainly used in ship yards, car and railway industry. Thicker sections should be preheated (150 °C) prior to welding. <b>Aluminum alloys: AlMg3, AlMg4, AlMg5, AlMgMn, AlZnMg1, G-AlMg3Si, G-AlMg5Si, G-AlMg10, AlMg1SiCu, AlMgSi0,7, AlZn4,5Mg1, AlSi1MgMn, AlSiMg(A), 3.3545, 3.3206, 3.3210, 3.2315, 3.3211, 3.4335, EN AW 5086, EN AW 6060, EN AW 6005A, EN AW , EN AW 6061, EN AW 7020, EN AC 51400, EN AC 51300, EN AC 51100, EN AW 5454</b>
CEWELD AlMg 5 Tig	A 5.10: ER 5356			



TYPE	EN -ISO and ASME -AWS	MECHANICAL PROPERTIES	ANALYSIS	APPLICATION
<b>17. GMA/GTA (MIG/TIG) WELDING OF TITANIUM ALLOYS</b>				
CEWELD ERTi-1	Sect IX QW-432: F-No. 51 24034: S Ti 0100 (Ti99,8) A 5.16: ER Ti 1	T > 320 MPa Y > 250 MPa E > 24 %	C < 0,03 O 0,03 - 0,10 N < 0,012 H < 0,005 Fe < 0,08 Ti Rest	ERTi-1 is a <b>solid titanium</b> welding rod. Grade 1 (purest grade) <b>Grade 1</b> is the lowest strength unalloyed (or Commercially Pure-CP) grade. Grade 1 is used in applications where ductility is paramount, such as explosive cladding, loose linings, expanded metal, and deep drawing applications. It is also used in electrolytic applications like coated anode substrates for production of chlorine and sodium chlorate. <b>Titanium grade 1, 2, 3 and 4.</b>
CEWELD ERTi-2	Sect IX QW-432: F-No. 51 24034: S Ti 0120 (Ti 99,6) A 5.16: ER Ti 2	T > 395 MPa Y > 275 MPa E > 20 %	C < 0,03 O 0,08 - 0,16 N < 0,015 H < 0,008 Fe < 0,12 Ti Rest	ERTi-2 is a <b>solid titanium welding wire and rod</b> . He is developed for <b>welding titanium grade 1, 2, 3 and 4</b> . This alloy finds his applications in chemical industry and offers excellent weldability. <b>Titanium grade 1, 2, 3 and 4.</b>
CEWELD ERTi-5	Sect IX QW-432: F-No. 55 24034: S Ti 6402C (TiAl6V4B) A 5.16: ER Ti 5	T > 890 MPa Y > 810 MPa E > 10 %	C < 0,05 O 0,12 - 0,20 N < 0,03 H < 0,15 Fe < 0,22 Al 5,5 - 6,75 V 3,5 - 4,5 Ti Rest	ERTi-5 is a <b>solid titanium based welding rod (Grade 5)</b> with extreme high strength. Grade 5 is used in aircraft components such as landing gear, wing spars, and compressor blades. Its corrosion resistance is generally comparable to Grade 2 and it is often used in corrosion service where higher strength is required, particularly in shafts, high strength bolting, and keys. <b>Titanium grade 5, UNS R56400, AMS 4954</b>
CEWELD ERTi-7	Sect IX QW-432: F-No. 51 24034: S Ti 2401 (TiPd0,2A) A 5.16: ER Ti 7	T > 345 MPa Y > 275 MPa E > 20 %	C < 0,03 O 0,08 - 0,16 N < 0,015 H < 0,008 Fe < 0,12 Pd 0,12-0,15 Ti Rest	ERTi-7 is a <b>solid titanium Grade 7 based welding rod</b> . Grade 7 has the same mechanical properties as Grade 2. The 0.12 % palladium addition improves corrosion performance under mildly reducing conditions or where crevice or under-deposit corrosion is a problem. ERTi-7 can be considered for welding Grade 2 or 16 where improved corrosion performance is desired. <b>Titanium grade 7, Grade 2, Grade 16</b>
CEWELD ERTi-12	Sect IX QW-432: F-No. 54 24034: S Ti 3401 (TiNi0,7Mo0,3) A 5.16: ER Ti 12	T > 480 MPa Y > 345 MPa E > 20 %	C < 0,03 O 0,08 - 0,16 N < 0,015 H < 0,008 Fe < 0,12 Mo 0,2 - 0,4 Ni 0,6 - 0,9 Ti Rest	ER Ti-12 is an intermediate strength grade originally developed to provide enhanced crevice-corrosion resistance in high temperature brines, but at lower cost than Grade 7. The improved performance is believed to be the result of Ni <sup>++</sup> and Mo <sup>+++</sup> - ions that alter the surface electrochemistry of the material in the crevice or under a surface deposit. Grade 12 has better elevated temperature properties than Grade 2 or 3 and is sometimes specified for pressure vessels or piping for its superior strength alone. <b>Titanium grade 12, Grade 7, Grade 2 and Grade 3.</b>
<b>18. (TB) BRAZING OF COPPER ALLOYS</b>				
CEWELD CuAg	Sect IX QW-432: F-No. 31 24373: Cu1897 / CuAg1 A 5.7: ER Cu	T > 200 MPa E > 30 % I > 75J (20 °C)	Cu 99,5+Ag Ag 0,8-1,0 Al < 0,01 Fe < 0,05 Mn < 0,2 Ni+Co < 0,3 P 0,01 - 0,05 Pb < 0,01 Si < 0,1 As < 0,05	<b>CuAg</b> is a <b>copper brazing filler metal alloyed</b> with silver. Copper alloy, silver-alloyed- with a <b>slightly higher percentage of phosphor</b> , suitable for MIG welding, easy to handle, high plasticity of the weld metal. - High quality alloyed copper wire - The weld metal is a Copper-Silver alloy - Sound, pore-free deposits and high electrical conductivity - Excellent corrosion resistance
CEWELD CuSi3	Sect IX QW-432: F-No. 32 24373: Cu 6560 / CuSi3Mn1 A 5.7: ER CuSi-A	T > 350 MPa E > 40% I > 60J (20 °C)	Cu Rest Al < 0,01 Fe < 0,5 Mn < 1,5 Pb < 0,02 Si 2,8 - 4,0 Sn < 1,0 Zn < 1,0 Andere < 0,5	<b>CuSi3</b> is a <b>copper-Silicon welding wire for MIG brazing / TIG welding for welding thin plates</b> and or galvanized plates in the car industry and also for cladding CuMn, CuSiMn and CuZn alloys. Suitable for cladding cast iron and un- and low alloyed steels. Examples: <b>Automobile industry</b> , art work, cladding on steel, cast iron and copper alloys etc.
<b>19. GMA/GTA (MIG/TIG) WELDING OF COPPER ALLOYS</b>				
CEWELD CuSn	Sect IX QW-432: F-No. 31 24373: Cu 1898A/ CuSn1 A 5.7: ER Cu	T > 220 MPa 60 HB	Cu > 98 Al < 0,01 Mn < 0,5 P < 0,015 Pb < 0,01 Si < 0,5 Sn 0,8 - 1,0	<b>CuSn</b> is a <b>copper welding wire and rod alloyed</b> with Sn for Mig and Tig welding. Boilers and tubes out of copper or copper alloys, oven soldering etc. <b>Bronze alloy with minimally 0.8 tin</b> for virtually all welding procedures. Very good deoxidization. Surfacing and joining of Cu and copper- alloys. Widely used in oven soldering.

## SOLID WIRE

TYPE	EN -ISO and ASME -AWS	MECHANICAL PROPERTIES	ANALYSIS	APPLICATION
CEWELD CuSn6  CEWELD CuSn6 Tig	Sect IX QW-432: F-No. 33 24373: Cu 5180A / CuSn6P A 5.7: ER CuSn-A	T > 280 MPa E > 20 % I > 32 J (20 °C)	Cu Rest Al < 0,01 Fe < 0,1 P < 0,01- 0,45 Pb < 0,02 Si < 0,5 Sn 4,0 - 7,0 Zn < 0,1	<b>CuSn6 is a tin bronze alloy of minimally 6% tin</b> for virtually all brazing procedures MIG and Tig. Very good deoxidization and high hardness similar to cast bronzes. Surfacing and joining of Copper and CuSn-alloys. Widely used and recommended for oven soldering. <b>- High quality alloyed copper wire</b> <b>- Sound, pore free deposits and good electrical conductivity</b> <b>- Good corrosion resistance against seawater</b> <b>- Excellent sliding properties (bearings etc.)</b>
CEWELD CuSn12  CEWELD CuSn12 Tig	Sect IX QW-432: -- 24373: Cu 5410 / CuSn12P A 5.7: --	T > 350 MPa E > 5 % I > 8J (20 °C)	Cu Rest Al < 0,005 P 0,01 - 0,4 Pb < 0,02 Zn < 0,1 Sn 4,0 - 7,0	<b>CuSn12 is a tin bronze alloy with high percentage of tin</b> for virtually all brazing procedures MIG and Tig. Very good deoxidization and high hardness similar to cast bronzes. Surfacing and joining of Copper and CuSn-alloys. Widely used and recommended for oven soldering. <b>- High quality alloyed copper wire</b> <b>- Sound, pore free deposits and good electrical conductivity</b> <b>- Good corrosion resistance against seawater</b> <b>- Excellent sliding properties (bearings etc.)</b>
CEWELD CuAl8  CEWELD CuAl8 Tig	Sect IX QW-432: F-No. 36 24373: Cu 6100 / CuAl7 A 5.7: ER CuAl-A1	T > 430 MPa E > 40 % I > 100J (20 °C)	Cu Rest Al 6,0 - 8,4 Mn < 0,5 Pb < 0,02 Si < 0,1 Zn < 0,2	<b>CuAl 8 is a copper aluminum alloy for wire and rod</b> for welding and brazing. <b>Rebuilding brass ship propellers</b> and cladding surfaces against wear and corrosion attack. Welding galvanized plates or stainless steel sheets and suitable for cladding cast iron and un- and low alloyed steels. Brass, copper, steel, CuZn alloys, Ship propeller, AISI 304, sliding Surface, shafts, bearings etc.
CEWELD CuAl8Ni2  CEWELD CuAl8Ni2 Tig	Sect IX QW-432: -- 24373: Cu 6327 / CuAl8Ni2Fe2Mn2 A 5.7: --	T > 530 MPa E > 30 % I > 70J (20 °C)	Cu Rest Al 7,0 - 9,5 Fe 0,5 - 2,5 Mn 0,5 - 2,5 Ni+Co 0,5 - 3,0 Pb < 0,02 Si < 0,2 Zn < 0,2	<b>CuAl8Ni2 is a copper aluminum nickel alloy wire and rod</b> for brazing and welding. Joint welds or building up of aluminum bronze. Cladding components undergoing metal to metal wear under high pressure. Especially suited for marine environments. The addition of nickel improves corrosion resistance in heat and rough seawater. This filler metal with increased strength and corrosion properties is very well suited for Ship propellers, shipbuilding, pump building, shafts, guide grooves etc. <b>W.no: 2.0916,2.0920, 2.0928, 2.0932, 2.0936, 2.0940, 2.0960, 2.0962, 2.0966, 2.0970, 2.0978, 2.0980.</b>
CEWELD CuAl8Ni6  CEWELD CuAl8Ni-6Tig	Sect IX QW-432: F-No. 37 24373: Cu 6328 / CuAl9Ni5Fe3Mn2 A 5.7: ER CuNiAl	T > 690 MPa E > 19 % I > 68J (20 °C)	Cu Rest Al 8,5 - 9,5 Fe 3,0 - 5,0 Mn 0,6 - 3,5 Ni+Co 4,0 - 5,5 Pb < 0,02 Si < 0,1 Zn < 0,1	<b>CuAl8Ni6 is a copper Aluminum Nickel alloy</b> for MIG and TIG welding. Desalting installations, CuNiAl ship propellers, cladding against corrosion, cladding against wear, gliding surfaces, shipbuilding, pump building, shafts, guide grooves, tube systems etc <b>CuNiAl, CuAlNi, aluminum bronze, ship propellers, 2.0923, UNS C63000, C630AlBz</b> , Joint welds or building up of aluminum bronze. Cladding (steel) components undergoing metal to metal wear under high pressure. <b>Especially suited for marine environments.</b> The addition of nickel improves corrosion resistance in heat and rough seawater
CEWELD CuAl9Fe	Sect IX QW-432: F-No. 36 24373: Cu6180 / CuAl10Fe A 5.7: ER CuAl-A2	T > 500 MPa E > 35 % I > 35J (20 °C) HB 140	Cu Rest Al 8,5 - 11 Fe 0,5 - 1,5 Pb < 0,02 Si < 0,1 Zn < 0,02	<b>CuAl9Fe is a Copper aluminum alloy</b> for wire for brazing. Joint welds or building up of aluminum bronze. Cladding components undergoing metal to metal wear. Joining steel to copper alloys, cast iron and or bronze. Suitable for seawater resistant applications. Joining steel to copper alloys, <b>cast iron and or bronze.</b> Excellent for metal spraying. Ship propellers, shipbuilding, pump building, shafts, guide grooves etc. <b>UNS : C 60600 - C 61600 - C 68700</b> <b>DIN : Cu Al5 - Cu Al8 - CuZn20Al2, W.no : 2.0916 - 2.0920 - 2.0960</b>
CEWELD CuNi10Fe  CEWELD CuNi10Fe Tig	Sect IX QW-432: -- 24373: Cu 7061 / CuNi10 A 5.7: -	T > 300 MPa E > 34 % I > 190J (20 °C) HB 80	Cu Rest Fe 0,5 - 2,0 Mn 0,5 - 1,5 Ni+Co 9 - 11 P < 0,02 Pb < 0,02 Si < 0,2	<b>CuNi10Fe is a Copper-nickel alloy wire and rod</b> for welding and brazing. Is well suited for <b>highly stressed</b> , corrosion-resistant buildup welds on cast iron and on unalloyed and <b>low-alloy steels, seawater-resistant CuZn</b> alloys. Well suited for welding on CuNi materials. Especially recommended for plant construction . Cunifer 10, cuni10fe, seawater resistant, marine applications, tubes, pump building, offshore etc.
CEWELD CuNi30Fe  CEWELD CuNi30Fe Tig	Sect IX QW-432: F-No. 34 24373: Cu 7158 / CuNi30Mn1FeTi A 5.7: ER CuNi	T > 420 MPa E > 36 % I > 240J (20 °C) HB 115	Cu Rest Fe 0,4 - 0,7 Mn < 1,0 Ni+Co 29 - 32 P < 0,02 Pb < 0,02 Si < 0,25 S < 0,01 Ti 0,2-0,5	<b>CuNi30Fe is a Copper-nickel alloy wire and rod</b> for welding and brazing. This Copper-Nickel weld metal is <b>widely used for marine</b> and desalination applications. Dissimilar-welding applications for this alloy are joints between Monel alloys or <b>Nickel 200 and Copper-Nickel</b> alloys. Often used for surfacing on steel by using Ceweld NiTi-3 as a barrier layer. Shipbuilding, seawater evaporation plants, tubes, pump building, offshore, desalting equipment and parts etc. <b>(Monel 67): Wrought and cast alloys of 70-30, 80-20 and 90-10 copper nickel alloys, Monel 450, (alloy 450), Nickel 200, CuNi10Fe, CuNi20Fe (2.0878), CuNi30Fe (2.0882).</b>

3



# 4 - WIRES, STRIP AND FLUX FOR SAW



WELDING  
CONSUMABLES

CEWELD®

## Ceweld FL 838

Basic agglomerated flux for submerged arc welding with stainless steel and Nickel based alloys.

25

Kg

02 - 16

mm

Redry 300-350°C for min. 2h

Current DC+AC



Cewelds BV  
Cijmalaan 2  
8531 CA Huisdorp  
www.ceweld.com

Use for repair structures in corrosive media and concrete structures  
COP. Ceweld FL 838

Approvals: CE

EN ISO 14174 S A AF 2 DC



Art. nr.: FL838BAG

Lot nr.: 888487



# SAW

No.	Group	Page
0	OVERVIEW OF THE PRODUCTS	4/3-4
<b>SOLID WIRE FOR JOINT WELDING</b>		
1	SOLID WIRE FOR WELDING NON ALLOYED STEEL	4/5
2	SOLID WIRE FOR WELDING CREEP RESISTANT STEEL	4/5-6
3	SOLID WIRE FOR WELDING FINE GRAIN STEEL	4/6
4	SOLID WIRE FOR WELDING STAINLESS STEEL	4/7-8
5	SOLID WIRE FOR WELDING NICKEL BASE ALLOYS	4/8
<b>SOLID WIRE FOR HARDFACING</b>		
6	SOLID WIRE AGAINST WEAR	4/9
7	SAW / ESW STRIP AGAINST WEAR	4/9
8	SAW / ESW STRIP CLADDING AGAINST CORROSION	4/9
9	SAW / ESW STRIP CLADDING OF NICKEL BASED ALLOYS	4/10
<b>CORED WIRE FOR SAW JOINT WELDING</b>		
10	CORED WIRE FOR WELDING NON-ALLOYED STEEL	4/10
11	CORED WIRE FOR WELDING CREEP RESISTANT STEEL	4/11
12	CORED WIRE FOR WELDING FINE GRAIN STEEL	4/11
<b>CORED WIRE FOR HARDFACING</b>		
13	CORED WIRE AGAINST WEAR	4/12
<b>SAW AND ESW FLUXES FOR JOINT WELDING AND HARDFACING</b>		
14	SAW AND ESW FLUXES	4/13

## CLICK HERE FOR EXTENDED SEARCH



**Disclaimer:** Whilst all reasonable efforts have been made to ensure the accuracy of the information contained, the information contained or otherwise referenced herein is presented only as "typical" without guarantee or warranty, and any liability incurred from any reliance thereon is expressly disclaimed. Typical data are those obtained when welded and tested in accordance to prescribed standards, and should not be assumed to be the expected results in a particular application or weldment. Other tests and procedures may produce different results. Users are cautioned to confirm by qualification testing, or other appropriate means, the suitability of any welding consumable and procedure before use in the intended application. The selection and use of specific products is solely within the control of, and remains the sole responsibility of the customer. The right to change design and/or specifications without notice is reserved.

**Certilas Nederland B.V. | Gloxinialaan 2, 6851 TG Huissen, The Netherlands | info@certilas.com | www.certilas.com | Rev.2023.**

No.	Product Name	ISO	ASME	FM Group	F-Number:	Page
<b>1. SOLID WIRE FOR WELDING NON-ALLOYED STEEL</b>						
1	CEWELD S1	14171-A: S1	A 5.17/5.23: EL12	FM1	F-No. 6	4/5
2	CEWELD S2	14171-A: S2	A 5.17/5.23: EM12(K)	FM1	F-No. 6	4/5
3	CEWELD S3	14171-A: S3	A 5.17/5.23: EH10K	FM1	F-No. 6	4/5
4	CEWELD S2Si	14171-A: S2Si	A 5.17/5.23: EM12K	FM1	F-No. 6	4/5
5	CEWELD S3Si	14171-A: S3Si	A 5.17/5.23: EH12K	FM1	F-No. 6	4/5
<b>2. SOLID WIRE FOR WELDING CREEP RESISTANT STEEL</b>						
6	CEWELD S2 Mo	14171-A: S2Mo / 24598-A: S Mo	A 5.23: EA2	FM3	F-No. 6	4/5
7	CEWELD S3 Mo	14171-A: S3Mo / 24598-A: S MnMo	A 5.23: EA4	FM3	F-No. 6	4/5
8	CEWELD S4 MoSi	14171-A: S4Mo	A 5.23: EA3	FM3	F-No. 6	4/5
9	CEWELD S2 CrMo1	24598-A: S CrMo1	A 5.23: EB2(R)	FM3	F-No. 6	4/6
10	CEWELD S2 CrMo2	24598-A: S Z CrMo2Mn	A 5.23: EB3	FM3	F-No. 6	4/6
11	CEWELD S1 CrMo5	24598-A: S CrMo5	A 5.23: EB6	FM4	F-No. 6	4/6
12	CEWELD SA 80S-B8	24598-A: S CrMo9	A 5.23: EB8	FM4	F-No. 6	4/6
13	CEWELD SA 90S-B9	24598-A: S CrMo91	A 5.23: EB91	FM4	F-No. 6	4/6
<b>3. SOLID WIRE FOR WELDING FINE GRAIN STEEL</b>						
14	CEWELD S3 NiMo1	14171-A: S3Ni1Mo / 26304-A: S3Ni1Mo	A 5.23: EF 3	FM2	F-No. 6	4/6
15	CEWELD S3 NiMoCr	26304-A: S3Ni2,5CrMo	A 5.23: ~EM4 (EM4mod)	FM2	F-No. 6	4/6
<b>4. SOLID WIRE FOR WELDING STAINLESS STEEL</b>						
16	CEWELD SA 307	14343-A: ~S 18 8 Mn	A 5.9: ER307	FM5	F-No. 6	4/7
17	CEWELD SA 308L	14343-A: S 19 9 L	A 5.9: ER308L	FM5	F-No. 6	4/7
18	CEWELD SA 309L	14343-A: S 23 12 L	A 5.9: ER309L	FM5	F-No. 6	4/7
19	CEWELD SA 309L Mo	14343-A: S 23 12 3 L	A 5.9: ~ER309L Mo	FM5	F-No. 6	4/7
20	CEWELD SA 310	14343-A: S 25 20	A 5.9: ER310	FM5	F-No. 6	4/7
21	CEWELD SA 316L	14343-A: S 19 12 3 L	A 5.9: ER316L	FM5	F-No. 6	4/7
22	CEWELD SA 317L	14343-A: S 18 15 3 L	A 5.9: ER317L	FM5	F-No. 6	4/7
23	CEWELD SA 318	14343-A: S 19 12 3 Nb	A 5.9: ER318Si	FM5	F-No. 6	4/7
24	CEWELD SA 347	14343-A: S 19 9 Nb	A 5.9: ER347	FM5	F-No. 6	4/7
25	CEWELD SA 2209	14343-A: S 22 9 3 N L	A 5.9: ER2209	FM5	F-No. 6	4/7
26	CEWELD SA 904L	14343-A: S 20 25 5 Cu L	A 5.9: ER385	FM5	F-No. 6	4/8
27	CEWELD SA 2594	14343-A: S 25 9 4 N L	A 5.9: ER2594	FM5	F-No. 6	4/8
<b>5. SOLID WIRE FOR NICKEL BASED ALLOYS</b>						
28	CEWELD SA Micro 600	18274-A: S Ni 6082 (NiCr20Mn3Nb)	A 5.14: ER NiCr-3	FM6	F-No. 43	4/8
29	CEWELD SA Micro 625	18274-A: S Ni 6625 (NiCr22Mo9Nb)	A 5.14: ER NiCrMo-3	FM6	F-No. 43	4/8
30	CEWELD SA Alloy 825	18274-A: S Ni8065 (NiFe30Cr21Mo3)	A 5.14: ER NiFeCr-1	FM6	F-No. 45	4/8
31	CEWELD SA Alloy C-276	18274-A: S Ni 6276 (NiCr15Mo16Fe6W4)	A 5.14: ER NiCrMo-4	FM6	F-No. 44	4/8
<b>6. SOLID WIRE FOR NICKEL BASED ALLOYS</b>						
32	CEWELD SA 410NiMo	14343-A: S 13 4 14700: S Fe7	A 5.9: ER 410NiMo	FM5	F-No. 6	4/9
33	CEWELD SA 420B	14343-B: 420 14700: S Fe7	A 5.9: ER 420	FM5	F-No. 6	4/9
34	CEWELD SA 430	14343-A: S 17 14700: S Fe7	A 5.9: ER 430	FM5	F-No. 6	4/9
<b>7. ESW STRIP AGAINST WEAR</b>						
35	CEWELD SAS 550-VW	14700: ~ S Fe8	-	-	-	4/9
<b>8. SAW/ESW STRIP FOR CLADDING AGAINST CORROSION</b>						
36	CEWELD SA 308L strip	14343-A: 19 9 L	A 5.9: EQ 308L	-	-	4/9
37	CEWELD SA 309 L Mo strip	14343-A: 23 12 3 L	A 5.9: EQ 309 L Mo	-	-	4/9
38	CEWELD SA 309 L Nb strip	14343-A: 23 12 L Nb	A 5.9: EQ 309 L Nb	-	-	4/9
39	CEWELD SA 316 L strip	14343-A: 19 12 3 L	A 5.9: EQ 316L	-	-	4/9
40	CEWELD SA 347 strip	14343-A: 19 9 Nb	A 5.9: EQ 347	-	-	4/9
<b>9. SAW / ESW STRIP FOR CLADDING NICKEL BASED ALLOYS</b>						
41	CEWELD SA Micro 600 strip	18274: B Ni 6082 (NiCr20Mn3Nb)	A 5.14: ERNiCr-3 (UNS N06082)	-	-	4/10
42	CEWELD SA Micro CA(6025) 602 strip	18274: B Ni6025 (NiCr25Fe10AlY)	A 5.14: E NiCrFe-12 (UNS N06025)	-	-	4/10
43	CEWELD SA Micro 625 strip	18274: B Ni 6625 (NiCr22Mo9Nb)	A 5.14: ER NiCrMo-3 (UNS N06625)	-	-	4/10
44	CEWELD SA Alloy 825 strip	18274: B Ni 8065 (NiFe30Cr21Mo3Cu3)	A 5.14: ER NiFeCr-1 (UNS N08065)	-	-	4/10

# SAW - Overview

No.	Product Name	ISO	ASME	FM Group	F-Number:	Page
<b>10. CORED WIRE FOR WELDING NON-ALLOYED STEEL</b>						
45	CEWELD SACW 460	14171-A: S 46 4 FB T3	A 5.17: F8A4-EC1 A 5.23: F8A4-ECG	FM1	F-No. 6	4/10
46	CEWELD SACW 460-1W	14171-A: S 46 4 FB T3 14171-A: S 4T 4 FB T3	A 5.23: F8A6-ECG (1W)	FM1	F-No. 6	4/10
47	CEWELD SACW 500 QT	14171-A: AW S 46 6 FB T3Ni1 14171-A: SR: S 46 6 FB T3Ni1	A 5.23: F8A8-ECG	FM1	F-No. 6	4/10
<b>11. CORED WIRE FOR WELDING CREEP RESISTANT STEEL</b>						
48	CEWELD SACW Mo (P1)	24598-A: S T Mo FB 24598-B: S 55 4 FB TU 1M3	A 5.23: F8A4-ECA1	FM4	F-No. 6	4/11
49	CEWELD SACW CrMo1 (P11)	24598-A: S T CrMo1 24598-B: S 55 4 FB TU SU1CM	A 5.23: EB2C A 5.23: F8P0-EB2	FM4	F-No. 6	4/11
50	CEWELD SACW CrMo2 (P22)	24598-A: S T Z CrMo2 FB 24598-B: S 62 0 FB TU 1CM	A 5.23: F9P2-ECB3-B3	FM4	F-No. 6	4/11
51	CEWELD SACW NiMo (P36)	24598-A: S T Z FB 24598-B: S 62 4 FB TU G	A 5.23: F9P4-ECG-G	FM4	F-No. 6	4/11
<b>12. CORED WIRE WELDING FINE GRAIN STEEL</b>						
52	CEWELD SACW 550	26304-A: S 55 6 FB T3Ni1Mo 26304-A: S69A6 FB TUN2M2	A 5.23: F9A8-ECF1-F1	FM2	F-No. 6	4/11
53	CEWELD SACW 690	26304-A: S 69 6 FB T3Ni2,5CrMo 26304-A: S76A6 FB TUN5CM3	A 5.23: F11A8-ECF5-F5	FM2	F-No. 6	4/11
54	CEWELD SACW 890	26304-A: S 89 4 FB T3Ni2,5Cr1Mo 26304-A: S89A6 FB TUN2M2	A 5.23: ~ F12A8-ECG	FM2	F-No. 6	4/11
<b>13. CORED WIRE AGAINST WEAR</b>						
55	CEWELD SACW 350	14700: T Fe2	-	-	-	4/12
56	CEWELD SACW 410NiMo	14700: T Fe7 (13 4)	A 5.9: ~ 410 NiMo	-	-	4/12
57	CEWELD SACW 410NiMoN	14700: Fe7 (13 4)	A 5.9: ~ 410 NiMo	-	-	4/12
58	CEWELD SACW 410NiMoNbV	14700: T Fe7(8) (13 4)	A 5.9: ~ 410 NiMo	-	-	4/12
59	CEWELD SACW MnCr	14700: T Fe9	A 5.13: EFeMnCr	-	-	4/12
<b>14. SAW / ESW WELDING FLUXES</b>						
60	CEWELD FL 155	14174: SA FB 1 55 AC H5	-	-	-	4/12
61	CEWELD FL 160	14174: SA FB 1 55 AC H5	-	-	-	4/12
62	CEWELD FL 180	14174: SA AR 1 76 AC H5	-	-	-	4/12
63	CEWELD FL 188	14174: SA AB 1 67 AC H5	-	-	-	4/12
64	CEWELD FL 400	14174: SA CS 3 C0,2 Cr3 AC	-	-	-	4/12
65	CEWELD FL 805	14174: SAAF 2 5644 DC	-	-	-	4/12
66	CEWELD FL 8111	14174: SA FB 1 65 AC H5	-	-	-	4/12
67	CEWELD FL 830 ESHC	14174: ES A FB 2B 5644 DC	-	-	-	4/13
68	CEWELD FL 838	14174: SAAF 2 5644 DC H5	-	-	-	4/13
69	CEWELD FL 839	14174: SA FB 2 DC	-	-	-	4/13
70	CEWELD FL 851	14174: SA AB 1 67 AC H5	-	-	-	4/13
71	CEWELD FL 860 ESHC	14174: ES A FB 2	-	-	-	4/13
72	CEWELD FL 880	14174: SF CS 2 5742 DC	-	-	-	4/13
73	CEWELD FL 915	14174: SA FB 1 65 DC H5	-	-	-	4/13
74	CEWELD FL CS155	14174: SF CS 1 56 AC H5	-	-	-	4/13
75	CEWELD FL CS165	14174: SF CS 1 65 AC H5	-	-	-	4/13

TYPE	EN -ISO and ASME -AWS	MECHANICAL PROPERTIES	ANALYSIS	APPLICATION
------	-----------------------	-----------------------	----------	-------------

## 1. SOLID WIRE FOR WELDING NON-ALLOYED STEEL

<b>CEWELD S1</b>	19606-1: FM1 Sect IX QW-432: F-No. 6 14171-A: S1 A 5.17: EL12 Flux (FL 180) 14171-A: S 38 AAR S1 A 5.17/5.23: F7AZ-EL12	with FL180 T 480-600 MPa Y > 400 MPa E > 22% I ~ 60J (0 °C)	C 0,04 - 0,14 Si < 0,10 Mn 0,35 - 0,6	S1 is a Solid wire for CMn and mild steels with yield strength up to ~360 MPa Typical with FL180 Flux. S185-E360, S235JR-S355JR, S235J0-S355J0, S235J2-S355J2, Shipbuilding grades A-E, AH36, DH36, Boiler steels P235GH, P355GH
<b>CEWELD S2</b>	19606-1: FM1 Sect IX QW-432: F-No. 6 14171-A: S2 A 5.17: EM12(K) Flux (FL 188) 14171-A: S 42 3 AB S2 A 5.17/5.23: F7A4/P4-EM12(k)	with FL188 T 500-640 MPa Y > 420 MPa E > 22% I ~ 60J (-30 °C)	C 0,07-0,15 Si < 0,10 Mn 0,8 -1,25	S2 is a Solid wire for CMn and mild steels with yield strength up to ~420 MPa Typical with FL188. Flux S275N-S420N, S275M-S420M, Fine grain P275N-P355N, Pipe steels L415N/X60 Shipbuilding grades A-E, AH40-EH40, Boiler steels P235GH-P355GH
<b>CEWELD S3</b>	19606-1: FM1 Sect IX QW-432: F-No. 6 14171-A: S3 A 5.17: EH10K Flux (FL 155) 14171-A: S 46 6 FB S3 A 5.17 /23: F8A8 / F7P8-EH10K	with FL155 T 550-680 MPa Y > 470 MPa E > 20% I ~ 80J (-40 °C) I ~ 60J (-60 °C)	C 0,07 - 0,15 Si 0,05 - 0,15 Mn 1,30 - 1,70	S3 is a Solid wire for CMn and mild steels with yield strength up to ~460 MPa Typical with FL 155 Flux. S275N-S420N, S275M-S420M, Fine grain P355N/S355NL-P460M/S460NL Shipbuilding grades A-E, AH40-EH40, Boiler steels P235GH-P355GH
<b>CEWELD S2Si</b>	19606-1: FM1 Sect IX QW-432: F-No. 6 14171-A: S2Si A: 5.17: EM12K Flux (FL 188) 14171-A: S 42 2 AR S2Si A 5.17/23: F7A0-EM12K	with FL188 T 500-640 MPa Y > 420 MPa E > 22% I ~ 60J (0 °C)	C 0,07 - 0,15 Si 0,15 - 0,35 Mn 0,80 - 1,25	S2Si is a Solid wire for CMn and mild steels with yield strength up to ~420 MPa Typical with FL 188 Flux. S185-E360, S235JR-S355JR, S235J0-S355J0, S235J2-S355J2, Shipbuilding grades A-E, AH36, DH36, Boiler steels P235GH-P355GH
<b>CEWELD S3Si</b>	19606-1: FM1 Sect IX QW-432: F-No. 6 14171-A: S3Si A 5.17: EH12K Flux (FL 155) 14171-A: S 46 6 FB S3Si 5.17 /23: F8A8/F7P8-EH12K	with FL155 T 550-680 MPa Y > 470 MPa E > 20% I ~ 100J (-40°C) I ~ 60J (-60°C)	C 0,07- 0,15 Si 0,25 - 0,40 Mn 1,50 -1,85	S3Si is a Solid wire for CMn and mild steels with yield strength up to ~460 MPa Typical with FL 155 Flux. S355ML-S460ML, S460Q, S460QL, P355GH, P355N-P460N, P355NL2-P460NL2, P355M-P460M, P355ML2-P460ML2, P355Q-P460Q Shipbuilding grades A-E, AH40-FH40

## 2. SOLID WIRE FOR WELDING CREEP RESISTANT STEEL

<b>CEWELD S2Mo</b>	9606-1: FM3 Sect IX QW-432: F-No. 6 14171-A: S2Mo 24598-A: S Mo A 5.23: EA2 Flux (FL 155) 14171-A: S 46 4 FB S2Mo A5.17/23: F8A4/F7P4-EA2-A2	with FL155 after PWHT T 550-680 MPa Y > 470 MPa E > 20% I ~ 100J (-20°C) I ~ 55J (-40°C)	C 0,08 - 0,15 Si 0,05 - 0,20 Mn 0,95 - 1,20 Mo 0,45 -0,65	S2Mo is a Solid wire for 0.5%Mo steels, i.e. P1. These steels are commonly used at service temperatures up to 500 °C and for some sub-zero structural applications. The 0.5% alloying improves creep performance compared to CMn steels and sees the alloy being used for boiler, pressure vessel and piping construction. Typical with FL 155 Flux S355J0, E335, P285NH, P310GH, S355J0Cu, 16Mo3, P315N - S420N, P315NH - P420NH fine grain structural steels up to S460N/P460N, large-diameter pipes up to L485MB
<b>CEWELD S3Mo</b>	9606-1: FM3 Sect IX QW-432: F-No. 6 14171-A: S3Mo 24598-A: S MnMo A 5.23: EA4 Flux (FL 155) 14171-A: S 5T 3 FB S3Mo A5.17/23: F9TA2-EA4	with FL155 after PWHT T 620-760 MPa Y > 540 MPa E > 17% I ~ 100J (0°C) I ~ 70J (-20°C)	C 0,07 - 0,15 Si 0,05 - 0,20 Mn 1,30 - 1,70 Mo 0,45 - 0,65	S3Mo is a Solid wire for 0.5%Mo steels, i.e. P1. These steels are commonly used at service temperatures up to 500 °C and for some sub-zero structural applications. The 0.5% alloying improves creep performance compared to CMn steels and sees the alloy being used for boiler, pressure vessel and piping construction. Typical with FL 155 Flux S355J0, E335, P285NH, P310GH, S355J0Cu, 16Mo3, P315N - S420N, P315NH - P420NH fine grain steels S460NL/P460N to S500QL/P500Q, pipe steels L360N/X52 to L555Q/X80
<b>CEWELD S4Mo</b>	9606-1: FM3 Sect IX QW-432 : F-No. 6 14171-A: S4Mo A 5.23: EA3 Flux (FL 155) 14171-A: S 50 4 FB S4Mo A 5.23: F9A6-EA3-A3	with FL155 after PWHT T 620-760 MPa Y > 540 MPa E > 17% I ~ 80J (0 °C) I ~ 50J (-30 °C)	C 0,07- 0,15 Si 0,05 - 0,20 Mn 1,65 - 2,20 Mo 0,45 - 0,65	S4Mo is a Solid wire for 0.5%Mo steels, i.e. P1. These steels are commonly used at service temperatures up to 500 °C and for some sub-zero structural applications. The 0.5% alloying improves creep performance compared to CMn steels and sees the alloy being used for boiler, pressure vessel and piping construction. Typical with FL 155 Flux S355J0, E335, P285NH, P310GH, S355J0Cu, P315N - S420N, P315NH - P420NH fine grain steels S460NL/P460N to S500QL/P500Q, pipe steels L485Q/X70 to L555Q/X80, heat resistant 16Mo3/A204 grade A and A209 grade T1

## SAW

TYPE	EN -ISO and ASME -AWS	MECHANICAL PROPERTIES	ANALYSIS	APPLICATION
CEWELD S2 CrMo1	9606-1: FM3 Sect IX QW-432: F-No. 6 24598-A: S CrMo1 A 5.23: EB2(R) Flux (FL 155) 24598-A: S CrMo1 FB A 5.23: F8P0-EB2R-B2R	with FL155 after PWHT T > 550-700 MPa Y > 470 MPa E > 20% I ~ 100J (20 °C) I ~ 50J (-20 °C)	C 0,08 - 0,15 Si 0,05 - 0,25 Mn 0,60 - 1,00 Cr 1,00 - 1,30 Mo 0,45 - 0,65	<b>S2CrMo1</b> is a <b>Solid wire</b> for high temperature creep resistant <b>1.25%Cr-0.5%Mo ferritic steel</b> , i.e. P11/P12. These steels are used for creep resisting applications <b>up to ~550 °C</b> . <b>Typical with FL 155 Flux</b> For matching <b>1.25%Cr-0.5%Mo</b> creep resisting ferritic steels. <b>13CrMo 4-5, 16CrMo 4-4, G-17CrMo 5-5, 24CrMo5, 25CrMo4</b>
CEWELD S2 CrMo2	9606-1: FM3 Sect IX QW-432: F-No. 6 24598-A: S Z CrMo2Mn A 5.23: EG Flux (FL 155) 24598-A: S Z CrMo2Mn FB A 5.23: F8P0-EG-EG	with FL155 after PWHT T > 570 MPa Y > 470 MPa E > 22% I ~ 100J (20 °C) I ~ 50J (-20 °C)	C < 0,10 Si 0,05 - 0,25 Mn 0,60 - 1,00 Cr 2,25 - 3,00 Mo 0,90 - 1,10	<b>S2CrMo2</b> is a <b>Solid wire</b> for for high temperature creep resistant <b>2.25%Cr-1%Mo ferritic steel</b> , i.e. P21/P22. These steels are used for creep resisting applications <b>up to ~600 °C</b> . <b>Typical with FL 155 Flux or FL 160</b> For matching 2.25%Cr-1%Mo creep resisting ferritic steels. <b>10CrMo 9-10, 10CrSiMoV 7, G-17CrMo 9-10</b>
CEWELD S1 CrMo5	9606-1: FM4 Sect IX QW-432 : F-No. 6 24598-A: S CrMo5 A 5.23: EB6 Flux (FL 880) 24598-A: S CrMo5 F CS A 5.23: F8P0-EB2R-B2R	with FL880 after PWHT T > 590 MPa Y > 470 MPa E > 22% I ~ 60J (20 °C)	C 0,03 - 0,10 Si 0,20 - 0,50 Mn 0,40 - 0,70 Cr 5,50 - 6,50 Mo 0,50 - 0,70	<b>S2CrMo5</b> is a <b>Solid wire</b> for high temperature creep resistant <b>5%Cr-0.5%Mo ferritic steel</b> . The 5%Cr-0.5%Mo creep resistant alloy is used for service up to ~600°C particularly in environments involving hot hydrogen gas. Typical applications are found in oil refineries. <b>Typical with FL 880 Flux</b> For matching 5%Cr-0.5%Mo creep resisting ferritic steels. <b>X12CrMo5, GX12CrMo5</b>
CEWELD SA 80S-B8	9606-1: FM4 Sect IX QW-432 : F-No. 6 24598-A: S CrMo9 A 5.23: EB8 Flux (FL 155) 24598-A: S CrMo9 FB A 5.23: F8P0-EB8-EB8	with FL155 after PWHT T > 700 MPa Y > 560 MPa E > 22% I ~ 60J (20 °C)	C < 0,08 Si 0,2 - 0,50 Mn 0,30 - 0,65 Cr 8,0 - 10,50 Mo 0,80 - 1,20	<b>SA 80S-B8 (S CrMo9)</b> is a <b>Solid wire</b> for high temperature creep resistant <b>9%Cr-1%Mo ferritic steel</b> , i.e. P9. The 9%Cr-1%Mo creep resistant alloy is used for service <b>up to ~600 °C</b> particularly in environments involving hot hydrogen gas. Typical applications are found in oil refineries. <b>Typical with FL 155 Flux or FL 160</b> For matching 9%Cr-1%Mo creep resisting ferritic steels. <b>ASTM: A182/A336 F9, A199/A213 T9, A217 C12, A234 WP9, A335 P9, A387 P9, X12CrMo 9 1, GX12CrMo 10 1</b>
CEWELD SA 90S-B9	9606-1: FM4 Sect IX QW-432 : F-No. 6 24598-A: S CrMo91 A 5.23: EB91 Flux (FL 155) 24598-A: S CrMo91 FB A 5.23: F8P0-EB91-EB91	with FL155 after PWHT T > 700 MPa Y > 560 MPa E > 22% I ~ 100J (20 °C)	C < 0,08 Si < 0,50 Mn 0,40 - 1,25 Cr 8,5 - 10,50 Ni 0,4 - 1,0 Mo 0,85 - 1,15 V 0,15 - 0,25	<b>SA 90S-B9 (S CrMo91)</b> is a <b>Solid wire</b> for high temperature, creep resisting, <b>modified 9%Cr-1%Mo</b> martensitic steel (T91/P91). T91/P91 steel is commonly used at service temperatures <b>up to 620 °C</b> . <b>Typical with FL 155 Flux or FL 160</b> For matching P91, 9%Cr-1%Mo modified, creep resisting martensitic steels. X10CrMoVNb 9 1 <b>ASTM: A182/A336 grade F91, A213 grade T91, A217 grade C12A, A234 grade WP91, A335 grade P91, A387 grade 91</b>
<b>3. SOLID WIRE FOR WELDING FINE GRAIN STEEL</b>				
CEWELD S3 NiMo1	9606-1: FM2 Sect IX QW-432 : F-No. 6 14171-A: S3Ni1Mo 26304-A: S3Ni1Mo 26304-A: S 55 6 FB S3Ni1Mo A 5.23: EF 3 A 5.23: F62A6/P6-EF3-F3 Flux (FL 155) 26304-A: S 55 6 FB S3Ni1Mo 5.17 /23: F9A8/P8-EF3-F3	with FL155 T > 700 MPa Y > 570 MPa E > 22% I ~ 100J (-40 °C) I ~ 60J (-60 °C)	C < 0,15 Si 0,1- 0,3 Mn 1,2 - 1,6 Ni < 1,0 Mo < 0,50	<b>S3 NiMo1</b> is a <b>Solid wire</b> for <b>high strength low alloy fine-grained steels with yield strengths up to ~550 MPa (80ksi)</b> . <b>Typical with FL 155 Flux or FL 160</b> <b>P460NL1, P460ML1, S460Q-S550Q, S460QL-S550QL, P460Q-P500Q, P460QL1-500QL1. 15NiCuMoNb5-6-4 (1.6368)</b> <b>ASTM: A182 grade F36, A335 grade P36, A533, A537</b>
CEWELD S3 NiMoCr	9606-1: FM2 Sect IX QW-432 : F-No. 6 26304-A: S3Ni2,5CrMo 26304-A: S 69 6 FB- S3Ni2,5CrMo A 5.23: ~EM4 ( EM4mod) A 5.23: F76A6/P6-EM4 mod.-M4 Flux (FL 155) 26304-A: S 69 6 FB- S3Ni2,5CrMo 5.17 /23: F8A8/F7P8-EH12K	with FL155 T > 770 MPa Y > 690 MPa E > 17% I ~ 80J (-40 °C) I ~ 75J (-60 °C)	C < 0,09 Si 0,1- 0,3 Mn 1,2 - 1,6 Ni < 2,5 Mo < 0,50 Cr < 0,50	<b>S3NiCrMo</b> is a <b>Solid wire</b> for <b>high strength low alloy fine-grained steels with yield strengths up to ~690 MPa (100ksi)</b> Welding procedure (including preheat temperature, interpass temperature and PWHT) will be dependent on the base material being welded, including its thickness, and any applicable design codes. <b>Remarkable crack resistant</b> weld metal in combination with very low hydrogen content. <b>Typical with FL 155 Flux</b> <b>S690, X80, X90, X100, S690QL1, Weldom 700, Dilimax, Naxtra 70, 10CrMo9-10, 16NiCrMo12-6, high strenght steels with yield &gt;690N/mm2, S500Q-S690Q, S500QL-S690QL, P500Q-P690Q, P500QL1</b> <b>ASTM: A514, A517. HY80, HY100, Q1(N), Oceanfit 100, Oceanfit 690)</b>



TYPE	EN -ISO and ASME -AWS	MECHANICAL PROPERTIES	ANALYSIS	APPLICATION
------	-----------------------	-----------------------	----------	-------------

## 4. SOLID WIRE FOR WELDING STAINLESS STEEL

CEWELD SA 307	9606-1: FM5 Sect IX QW-432: F-No. 6 14343-A: ~S 18 8 Mn A 5.9: ER 307 Flux (FL 838) 14174-A: S AAF 2 5644 DC H5	T > 550 MPa Y > 360 MPa E > 24% l ~ 50J (20 °C)	C 0,04 - 014 Si 0,30 - 0,65 Mn 3,30 - 4,75 Cr 19,5 - 20,0 Ni 8,00 - 10,0 Mo 0,50 - 1,50	SA 307 is a solid welding wire for SAW. Buffer layers before Hardfacing, Armor plate, (type 409, 304), high Manganese austenitic steel, heterogeneous welding, difficult to weld steels such as: <b>42CrMo4, C45, 42MnV7, tool steels etc.</b>
CEWELD SA 308L	9606-1: FM5 Sect IX QW-432: F-No. 6 14343-A: S 19 9 L A 5.9: ER 308L Flux (FL 838) 14174 - A: S AAF 2 5644 DC H5	T > 570 MPa Y > 350 MPa E > 35% l ~ 120J (20 °C) l ~ 50J (-196 °C)	C < 0,030 Si 0,30 - 0,65 Mn 1,0 - 2,50 Cr 19,5 - 21,0 Ni 9,00 - 11,0 Mo < 0,75	SA 308L is a solid wire for SAW stainless steel types with an alloy content between 16 to 21% Cr and 8 to 13 % Ni, for both stabilized and un-stabilized types. High weld metal quality and a attractive bead appearance. <b>W.no: 1.4306, 1.4301, 1.4541, 1.4550, 1.4311, 1.4546, 1.4312, 1.4300, 1.4312, 1.4371, 1.4541, 1.4543, 1.4550, 1.4452</b> <b>AISI 202, 302, 304L, 304, 305, 321, 347, 304 LN</b> <b>ASTM A320 Grade B8C/D, 302</b>
CEWELD SA 309L	9606-1: FM5 Sect IX QW-432: F-No. 6 14343-A: S 23 12 L A 5.9: ER 309 LS Flux (FL 838) 14174 - A: S AAF 2 5644 DC H5	T > 590 MPa Y > 390 MPa E > 30% l ~ 80J (20 °C)	C < 0,030 Si 0,30 - 0,65 Mn 1,0 - 2,50 Cr 23,0 - 25,0 Ni 12,0 - 14,0 Mo < 0,75	SA 309L is solid wire for SAW dissimilar steels and 13%Cr/18%Cr stainless steels, and is suitable for welding the first layer on low carbon steel to obtain a AISI 304 clad layer. Buffer layers before hard facing, dissimilar joints between ferritic and austenitic steels and or difficult to weld steels such as: <b>42CrMo4, C45, 42MnV7, tool steels, heat resistant steels etc.</b>
CEWELD SA 309LMo	9606-1: FM5 Sect IX QW-432: F-No. 6 14343-A: S 23 12 3 L A 5.9: ER 309 LMoD Flux (FL 838) 14174 - A: S AAF 2 5644 DC H5	T > 600 MPa Y > 450 MPa E > 25 % l ~ 60J (20 °C)	C < 0,030 Si 0,30 - 0,65 Mn 1,0 - 2,50 Cr 23,0 - 25,0 Ni 12,0 - 14,0 Mo 2,0 - 3,0	SA 309LMo is a solid wire for SAW which operates with very stable, spatter free arcs. This wire deposits low carbon weld metal of about 23%Cr-13%Ni-2.3%Mo. <b>Cladding on low alloyed steels in case a 18/8/2 CrNiMo layer is required in the first layer.</b> <b>W.no: 1.4401, 1.4404, 1.4406, 1.4410, 1.4437, 1.4571, 1.4580</b>
CEWELD SA 310	9606-1: FM5 Sect IX QW-432: F-No. 6 14343-A: S 25 20 A 5.9: ER 310 Flux (FL 838) 14174 - A: S AAF 2 5644 DC H5	T > 590 MPa Y > 390 MPa E > 45% l ~ 100J (20 °C) l ~ 60J (-196 °C)	C 0,08 - 0,15 Si 0,30 - 0,65 Mn 1,0 - 2,50 Cr 25,0 - 28,0 Ni 20,0 - 22,0 Mo < 0,75	SA 310 is a solid wire for SAW heat-resistant austenitic steels of the 25% Cr, 20% Ni types. SA 310 has good general oxidation resistance, especially at high temperatures, due to its high Cr content. The alloy is fully austenitic and is therefore sensitive to hot cracking. Stainless and high temperature steels: <b>W.no: 1.4826, 1.4828, 1.4835, 1.4837, 1.4840, 1.4841, 1.4845, 1.4846, 1.4847, 1.4848, 1.4710, 1.4713, 1.4724, 1.4726, 1.4742, 1.4745, 1.4762</b>
CEWELD SA 316L	9606-1: FM5 Sect IX QW-432: F-No. 6 14343-A: S 19 12 3 L A 5.9: ER 316L Flux (FL 838) 14174 - A: S AAF 2 5644 DC H5	T > 520 MPa Y > 370 MPa E > 35% l ~ 120J (20 °C) l ~ 55J (-196 °C)	C < 0,03 Si 0,30 - 0,65 Mn 1,0 - 2,50 Cr 18,0 - 20,0 Ni 11,0 - 14,0 Mo 2,0 - 3,0	SA 316L is a solid stainless steel SAW welding wire. The alloy is widely used in the chemical and food-processing industries, as well as in shipbuilding, vessel and various types of architectural structure. Suitable for welding corrosion-resistant Cr-Ni-Mo steels with extremely low C-content at working temperatures up to 350°C. <b>W.no.:1.4583,1.4435,1.4436,1.4404, 1.4406,1.4408,1.4401, 1.4571,1.4580,1.4406</b>
CEWELD SA 317L	9606-1: FM5 Sect IX QW-432: F-No. 6 14343-A: S 18 15 3 L A 5.9: ER 317L Flux (FL 838) 14174 - A: S AAF 2 5644 DC H5	T > 520 MPa Y > 390 MPa E > 35% l ~ 70J (20 °C)	C < 0,03 Si 0,30 - 0,65 Mn 1,0 - 2,50 Cr 18,5 - 20,0 Ni 13,0 - 15,0 Mo 3,0 - 4,0	SA 317L is a solid stainless steel SAW welding wire corrosion resistance is better than AISI 316 due to the high Mo. content and also offers excellent corrosion resistance against dilute hot acids. Suitable for use up to 400°C. SA 317L is best to be used in combination with FL 838W.no.:1.4439, 1.4429, 1.4438, 1.4583, X2CrNiMoN 17 13 5, X2CrNiMoN 17 13 3, X2CrNiMo 18 15 4, X10CrNiMoNb 18 12, 317LN, (TP)316LN, 317L, non magnetic, ferrite free. ASTM 317LMN, SS 2367
CEWELD SA 318	9606-1: FM5 Sect IX QW-432 : F-No. 6 ISO 14343-A: S 19 12 3 Nb A 5.9: ER 318 Flux (FL 838) 14174 - A: S AAF 2 5644 DC H5	T > 550 MPa Y > 350 MPa E > 35% l ~ 100J (20 °C) l ~ 40J (-120 °C)	C < 0,08 Si 0,30 - 0,65 Mn 1,0 - 2,50 Cr 18,0 - 20,0 Ni 11,0 - 14,0 Mo 2,0 - 3,0 Nb 8xC - 1,0	SA 318 is a solid wire electrode for SAW , suitable to weld 19Cr/12Ni/3Mo stabilized Ti grades like 1.4571 / 316Ti. Also suitable for the welding of similar non-stabilized grades 316 or 316L. SA 318 is suitable for service temperatures from -60 °C to 400 °C and has high resistance to intergranular corrosion. <b>W.no:1.4571/ X6CrNiMoTi17-12-2, 1.4580 / X6CrNiMoNb17-12-2, 1.4401/ X5CrNi-Mo17-12-2, 1.4581/ GX5CrNiMoNb19-11-2, 1.4437/ GX6CrNiMo18-12, 1.4583/ X10CrNiMoNb18-12, 1.4436/ X3CrNiMo17-13-3, AISI 316L, 316Ti, 316Cb</b>
CEWELD SA 347	9606-1: FM5 Sect IX QW-432: F-No. 6 14343-A: S 19 9 Nb A 5.9: ER 347 Flux (FL 838) 14174-A: S AAF 2 5644 DC H5	T > 570 MPa Y > 360 MPa E > 30% l ~ 80J (20 °C) l ~ 40J (-196 °C)	C < 0,08 Si 0,30 - 0,65 Mn 1,0-25 Cr 19,0 - 21,5 Ni 9,0 - 11,0 Mo < 0,75 Nb 10xC-1,0	SA 347 is a solid wire electrode for SAW, suitable to weld 18Cr/10Ni stabilized with Ti or Nb austenitic stainless steels grades 321 and 347. Also suitable for welding similar non-stabilized grades 304 or 304L. 347 has high resistance to intergranular corrosion. <b>W.no: 1.4550/ X6CrNiNb18-10, 1.4541/ X6CrNiTi18-10, 1.4552/ GX5CrNiNb19-11,1.4301/ X5CrNi18-10,1.4312/ GX10CrNi18-8, 1.4546/ X5CrNiNb18-10, 1.4311/ X2CrNi18-10, 1.4306/ X2CrNi19-11</b> <b>AISI 347, 321, 302, 304, 304L, 304LN, ASTM A296 Gr. CF 8 C, A157 Gr. C9, A320 Gr. B8C or D</b>
CEWELD SA 2209	9606-1: FM5 Sect IX QW-432: F-No. 6 14343-A: S 22 9 3 N L 5.9: ER 2209 Flux (FL 838) 14174-A: S AAF 2 5644 DC H5	T > 750 MPa Y > 550 MPa E > 26% l ~ 80J (+20°C) l ~ 40J (-60°C)	C < 0,03 Si < 0,90 Mn 0,5 - 2,0 Cr 21,5 -23,5 Ni 7,5 - 9,5 Mo 2,5 - 3,5 N 0,08 -0,20	SA 2209 is a solid wire electrode for SAW, suitable for welding duplex stainless steels grades 2205 and 2304. Weld metal exhibits corrosion resistance similar to grade 904L in most applications. 2209 is also suitable to weld grade 2205 or grade 2304 to mild steel. <b>W.no: 1.4162, 1.4462, X2CrNiMoN 22 5 3, 1.4362, X2CrNiN 23 4, 1.4463, 1.4460, 1.4583</b>

SAW				
TYPE	EN -ISO and ASME -AWS	MECHANICAL PROPERTIES	ANALYSIS	APPLICATION
CEWELD SA 904L	9606-1: FM5 Sect IX QW-432: F-No. 6 14343-A: S 20 25 5 Cu L 5.9: ER 385 <u>Flux (FL 838)</u> 14174-A: S AAF 2 5644 DC H5	T > 560 MPa Y > 380 MPa E > 35 % I ~ 70J (20 °C)	C < 0,03 Si < 0,50 Mn 1,0-2,5 Cr 19,5-21,5 Ni 24 - 26 Mo 4,2 - 5,2 Cu 1,2-2,0	<b>SA 904L</b> is a <b>solid wire</b> and used for welding materials of <b>similar chemical composition</b> which are used for fabrication of equipment and vessels for handling of sulfuric acid and many chloride containing media. This filler metal may also find applications for <b>joining Type 317L</b> material where improved corrosion resistance in specific media is needed. In order to reduce the propensity for fissuring and hot cracking, the low melting constituents such as carbon, silicon, and phosphorus are controlled to lower levels in this alloy. <b>W.no:1.4500, 1.4505, 1.4506, 1.4531, 1.4536, 1.4539, 1.4573, 1.4585, 1.4586, 4 NS N 08904 1.4539, 1.4537, 1.4519, 1.4505, UNS N08904, S31726, X1NiCrMoCu 25-20-5, X1CrNiMoCuN 25-25-5, X4NiCrMoCuNb 20-18-2, Uranus B6</b>
CEWELD SA 2594 (Super Duplex)	9606-1: FM5 Sect IX QW-432: F-No. 6 14343-A: S 25 9 4 N L 5.9: ER 25 9 4 <u>Flux (FL 838)</u> 14174-A: S AAF 2 5644 DC H5	T > 870 MPa Y > 680 MPa E > 26% I ~ 55J (-40 °C)	C < 0,03 Si < 1,0 Mn < 2,5 Cr 24 - 24 Ni 8,0 - 10,5 Mo 2,5 - 4,5 W < 1,0 N 0,20 - 0,30	<b>SA 2594</b> is a <b>solid wire electrode for SAW</b> , suitable for welding duplex stainless steels grades 2205 and 2304. Weld metal exhibits corrosion resistance similar to grade 904L in most applications. <b>SA 2594</b> is also suitable to weld grade 2205 or grade 2304 to mild steel. <b>UNS S32550 :UR 52 N, Ferralium 255, UNS S32520 :UR 52 N+, UNS S32750: SAF 2507, UR 47 N+, UNS S32760: ZERON 100, UNS 32760, UR 76 N, SM22Cr, SAF 2507, ASTM S32760 (ZERON 100), S32550 and S31260</b>
<b>5. SOLID WIRE FOR NICKEL BASED ALLOYS</b>				
CEWELD SA Nicro 600	9606-1: FM6 Sect IX QW-432: F-No. 43 18274-A: S Ni 6082 (NiCr20Mn3Nb) A 5.14: ERNiCr-3 <u>Flux (FL 839)</u> 14174: SA FB 2 DC <u>Flux (FL 838)</u> 14174-A: S AAF 2 5644 DC H5	T > 740 MPa Y > 440 MPa E > 35 % I ~ 70J (20 °C) I ~ 50J (-196 °C)	C < 0,1 Mn 2,5 - 3,5 Fe < 3,0 Si < 0,5 Cu < 0,5 Ni > 67 Ti < 0,7 Cr 20 - 22,5 Nb 2,0 - 3,0	<b>SA Nicro 600</b> filler metal is used for <b>SAW</b> welding nickel-chromium-iron ( <b>Inconel 600, 601 and 690</b> ) alloys to themselves, and for dissimilar welding between nickel-chromium-iron (Monel, Inconel and Incoloy) alloys and steels or stainless steels. The applications include surfacing as well as clad-side welding. <b>Alloy type : Inconel 600, 2.4816, 1.4876, 2.4817, 2.4851, 1.6901, NiCr15Fe, X10Ni-CrAlTi 32 20, LC-NiCr15Fe, NiCr23Fe, X3CrNiN 18 10, alloy 600/B168, alloy 800 / 800H(T), N 10665, N 06601, kiln tyre, difficult to Weld steels, cock wheel</b>
CEWELD SA Nicro 625	9606-1: FM6 Sect IX QW-432: F-No. 43 18274-A: S Ni 6625 (NiCr22Mo9Nb) A 5.14: ERNiCrMo-3 <u>Flux (FL 839)</u> 14174: SA FB 2 DC <u>Flux (FL 838)</u> 14174-A: S AAF 2 5644 DC H5	T > 760 MPa Y > 440 MPa E > 35 % I ~ 70J (20 °C) I ~ 50J (-196 °C)	C < 0,1 Mn < 0,5 Fe < 5,0 Si < 0,5 Ni ≥ 58 Al < 0,4 Ti < 0,4 Cr 20,0-23,0 Nb 3,2-4,1 Mo 8,0-10,0	<b>SA Nicro 625</b> is developed for <b>welding and cladding</b> nickel-based alloys such as alloy 625, 825 or similar materials. This alloy can also be used for welding dissimilar nickel-based alloys to each other, to alloyed steels, to stainless steels and for <b>joining 9% Nickel steels</b> . <b>X10NiCrAlTi, 32-20H, 32-21, X8 Ni9, ASTM A 533 Gr1, 800H, Sanicro 28, 254SMo, inconel 625, UNS : N08926, N08825, N06625, N08020. DIN : X8Ni9, X1NiCrMoCuN25 20 6, X1NiCrMoCuN25 20 5, NiCr21Mo, NiCr22Mo9Nb W.No: 1.4876, 1.5656, 1.4529, 2.4858, 2.4856, 1.4539,1.4547, 2.4660</b>
CEWELD SA Alloy 825	9606-1: FM6 Sect IX QW-432: F-No. 45 18274-A: S Ni8065 (Ni-Fe30Cr21Mo3) A 5.14: ER NiFeCr-1 <u>Flux (FL 839)</u> 14174: SA FB 2 DC <u>Flux (FL 838)</u> 14174-A: S AAF 2 5644 DC H5	T > 630 MPa Y > 425 MPa E > 30 % I ~ 100J(20 °C) I ~ 70J (-196 °C)	C < 0,05 Mn < 1,0 Fe ≥ 22 Si < 0,5 Cu 1,5-3,0 Ni 38,0-46,0 Al < 0,2 Ti 0,6-1,2 Cr 19,5-23,5 Mo 2,5 - 3,5	<b>SA Alloy 825</b> are used for welding <b>copper alloyed chromium-nickel-molybdenum alloys</b> , e.g. UNS N08904 and nickel-iron-chromium-molybdenum alloys, e.g. UNS N08825. They may also be used for surfacing of steel; a nickel alloy barrier layer is typically applied prior to weld overlay. <b>G-X7NiCrMoCuNb 25 20, X1NiCrMoCuN25 20 6, X1NiCrMoCuN25 20 5, NiCr21Mo, X1NiCrMoCu 31 27 4, N08926, N08904, ALLOY 825, N08028, UNS N08825 W.Nr: 1.4500, 1.4529, 1.4539 (904L), 2.4858, 1.4563, 1.4465, 1.4577 (310Mo), 1.4133, 1.4500, 1.4503, 1.4505, 1.4506, 1.4531, 1.4536, 1.4585, 1.4586</b>
CEWELD SA Alloy C-276	9606-1: FM6 Sect IX QW-432: F-No. 44 18274-A: S Ni 6276 (NiCr15Mo16Fe6W4) A 5.14: ER NiCrMo-4 <u>Flux (FL 839)</u> 14174: SA FB 2 DC <u>Flux (FL 838)</u> 14174-A: S AAF 2 5644 DC H5	T > 700 MPa Y > 400 MPa E > 35 % I ~ 80J (20 °C) I ~ 60J (-196 °C)	C < 0,2 Mn < 1,0 Fe 4,0-7,0 Si < 0,08 Cu < 0,50 Ni ≥ 50,0 Co < 2,5 Cr 14,5-16,5 Mo 15,0-17,0 W 3,0-4,5	<b>SA Alloy C-276</b> is used for welding <b>low carbon nickel-chromium-molybdenum alloys, especially UNS N10276</b> , for welding the clad side in steel clad with <b>low carbon nickel-chromium-molybdenum alloy</b> , and for welding low carbon nickel-chromium-molybdenum alloys to steel and other nickel-base alloys.

TYPE	EN -ISO and ASME -AWS	MECHANICAL PROPERTIES	ANALYSIS	APPLICATION
------	-----------------------	-----------------------	----------	-------------

## 6. SOLID WIRE AGAINST WEAR

<b>CEWELD SA 410NiMo</b>	9606-1: FM5 Sect IX QW-432: F-No. 6 14343-A: S 13 4 14700: S Fe7 A 5.9: ER 410NiMo <b>Flux (FL 838 / FL880)</b> 14174: SF CS 2 5742 DC	HRC 38 after PWHT HB 250	C < 0,05 Si < 0,5 Mn < 0,6 Cr 11,0-12,5 Ni 4,0-5,0 Mo 0,4-0,7 Cu < 0,75	<b>SA 410NiMo</b> is a <b>stainless solid SAW welding wire</b> of the <b>12% Cr, 4.5% Ni, 0.5% Mo type</b> . <b>410NiMo</b> is used for welding similar martensitic and martensitic-ferritic steels in different applications, such as hydro turbines. <b>Water and steam turbine parts of the same kind, thermoshock and high heat resistant. 1.4313, 1.4002, (G)X5CrNi(Mo) 13 4, X6CrAl 13, Grade CA 6 NM.</b>
<b>CEWELD SA 420B</b>	9606-1: FM5 Sect IX QW-432: F-No. 6 14343-B: 420 14700: S Fe7 A 5.9: ER 420 <b>Flux (FL 838 / FL880)</b> 14174: SF CS 2 5742 DC	HRC 50	C 0,25-0,40 Si < 0,5 Mn < 0,6 Cr 12,0-14,0 Ni < 0,75 Mo < 0,75 Cu < 0,75	<b>SA 420B</b> offers fair general corrosion resistance combined with high hardness and excellent wear properties especially to face metal to metal wear problems. The best all-purpose steel type for machine element work. Suitable for fairly corrosion resistant overlay welding with a hardness of approx. <b>50 HRC</b> .
<b>CEWELD SA 430</b>	9606-1: FM5 Sect IX QW-432: F-No. 6 4343-A: S 17 14700: S Fe7 A 5.9: ER 430 <b>Flux (FL 838 / FL880)</b> 14174: SF CS 2 5742 DC	HB 250	C < 0,10 Si < 0,5 Mn < 0,60 Cr 15,5-17,0 Ni < 0,6 Mo < 0,75 Cu < 0,75	<b>SA 430</b> is a <b>martensitic stainless steel SAW welding wire</b> for ferritic stainless steels It is a <b>17% chromium solid wire</b> . <b>1.4511, X3CrNb17, 1.4512, 1.4510, 1.4526, 1.4509, 1.4016, X6Cr17, AISI, 430 Cladding AISI 410, 410NiMo, 410NiMoNbV.</b>

## 7. ESW STRIP AGAINST WEAR

<b>CEWELD SAS 550-VW</b>	14700 : ~ C Fe8 <b>Flux (FL830 ESHC)</b> 14174: SF CS 2 5742 DC	HRC 52-58  T > 280 MPa Y > 280 MPa	C ~ 0,33 Mn ~ 2,80 W ~ 1,80 Cr ~ 7,0 Ni ~ 0,25 Mo ~ 1,70 V ~ 0,25	<b>SAS 550-VW</b> is a <b>sintered Hardfacing strip for rebuilding and overlay applications</b> . The weld deposit offers excellent wear resistance against shocks and abrasion as well. Already the first layer gives excellent results even on mild steel due to the low dilution of the electro slag process. Due to the low dilution with the base metal a hardness exceeding <b>50 HRC</b> can be achieved already in the first layer. Multiple layers can be applied to obtain full hardness at the final layer.
--------------------------	---	---	---	--

## 8. SAW/ESW STRIP FOR CLADDING AGAINST CORROSION

<b>CEWELD SA 308L strip</b>	14343-A: B 19 9 L A 5.9: EQ ER 308L <b>Flux (FL 830 ESHC)</b> 14174: SF CS 2 5742 DC	T > 600 MPa Y > 450 MPa	C < 0,03 Si 0,30 - 0,65 Mn 1,0 - 2,5 Cr 19,5- 22,0 Ni 9,0-10,0 Mo < 0,5	<b>SA 308L strip</b> is a <b>ESAW strip</b> with an alloy content between <b>16 to 21% Cr and 8 to 13 % Ni</b> , for both stabilized and un-stabilized types. High weld metal quality and a attractive bead appearance.
<b>CEWELD SA 309L Mo strip</b>	14343-A: B 23 12 3 L A 5.9: ~EQ 309 L Mo <b>Flux (FL 830 ESHC)</b> 14174: SF CS 2 5742 DC	T > 600 MPa Y > 450 MPa	C < 0,03 Si 0,30 - 0,65 Mn 1,0 - 2,5 Cr 23,0 - 25,0 Ni 12,0 -14,0 Mo 2,0 - 3,0	<b>SA 309L Mo strip</b> is a <b>stainless steel strip</b> for cladding overlay applications. Latest generation clean melting quality guarantees optimum metallurgical quality and attractive weld appeal. Combined with our high basic electro slag flux FL 830 ESHC excellent results are obtained in both deposition rate as minimum dilution rate due to the higher slag temperature compare to other electro slag fluxes. Cladding on low alloyed steels in case a 18/8/2 (AISI 316) <b>CrNiMo layer</b> is required in the first layer.
<b>CEWELD SA 309L Nb strip</b>	14343-A: B 23 12 L Nb A5.9: ~EQ 309 L Nb <b>Flux (FL830 ESHC)</b> 14174: SF CS 2 5742 DC	T > 600 MPa Y > 450 MPa	C < 0,03 Si 0,30 - 0,65 Mn 1,0 - 2,5 Cr 23,0 - 25,0 Ni 12,0 -14,0 Mo < 0,75 Nb 10xC - 1,0	<b>SA 309L Nb strip</b> is a <b>stainless steel strip</b> for cladding overlay applications. Latest generation clean melting quality guarantees optimum metallurgical quality and attractive weld appeal. Combined with our high basic electro slag flux FL 830 ESHC excellent results are obtained in both deposition rate as minimum dilution rate due to the higher slag temperature compare to other electro slag fluxes.
<b>CEWELD SA 316L strip</b>	14343-A: B 19 12 3 L A 5.9: EQ 316L <b>Flux (FL830 ESHC)</b> 14174: SF CS 2 5742 DC	T > 620 MPa Y > 440 MPa	C < 0,03 Si 0,30 - 0,65 Mn 1,0 - 2,5 Cr 18,0 - 20,0 Ni 11,0 -14,0 Mo 2,5-3,0	<b>SA 316 L strip</b> is a <b>stainless steel strip</b> for cladding overlay applications. Latest generation clean melting quality guarantees optimum metallurgical quality and attractive weld appeal. Combined with our high basic electro slag flux FL 830 ESHC excellent results are obtained in both deposition rate as minimum dilution rate due to the higher slag temperature compare to other electro slag fluxes. Cladding applications where a 18/8/2 (AISI 316) <b>CrNiMo layer</b> is required to offer good resistance against general corrosion, particularly to corrosion in acid and chlorinated environments.
<b>CEWELD SA 347 strip</b>	14343-A: B 19 9 Nb A 5.9: EQ 347 <b>Flux (FL830 ESHC)</b> 14174: SF CS 2 5742 DC	T > 570 MPa Y > 360 MPa	C < 0,08 Si 0,30 - 0,65 Mn 1,0 - 2,5 Cr 19,0 - 21,5 Ni 9,0 -11,0 Mo < 0,75 Nb 10xC - 1,0	<b>SA 347 strip</b> is a <b>stainless steel strip</b> for cladding overlay applications. Latest generation clean melting quality guarantees optimum metallurgical quality and attractive weld appeal. Combined with our high basic electro slag flux FL 830 ESHC excellent results are obtained in both deposition rate as minimum dilution rate due to the higher slag temperature compare to other electro slag fluxes.

SAW				
TYPE	EN -ISO and ASME -AWS	MECHANICAL PROPERTIES	ANALYSIS	APPLICATION

## 9. SAW / ESW STRIP CLADDING OF NICKEL BASED ALLOYS

CEWELD SA Nicro 600 strip	18274: S Ni 6082 (NiCr20Mn3Nb) A 5.14: EQ NiCr-3 (UNS N06082) <u>Flux (FL 860 ESHC)</u> 14174: ES A FB 2		C < 0,10 Mn 2,5-3,0 Fe < 3,0 Si < 0,50 Cu < 0,50 Ni > 67 Ti < 0,70 Cr 18 - 22 Nb 2,0 - 3,0	SA Nicro 600 strip is a solid Strip suitable for both electroslag (ESW) and subarc (SAW) process. Typical applications include cladding of vessels for the petrochemical, refinery and chemical industries. Weld metal deposited by SA Nicro 600 strip has high strength and good corrosion resistance, including oxidation resistance and creep-rupture strength at elevated temperatures.
CEWELD SA Nicro 602 CA (6025HT) strip	18274: S Ni6025 (NiCr25Fe10AlY) A 5.14: EQ NiCrFe-12 (UNS N06025) <u>Flux (FL 860 ESHC)</u> 14174: ES A FB 2		C 0,05 -0,15 Mn < 0,50 Fe 8,0 - 11 Si < 0,50 Cu < 0,10 Ni > 59 Al 1,8-2,4 Ti 0,10 -0,20 Cr 24-26	SA Nicro 602 CA (6025HT) strip is a solid Strip suitable for Electro slag cladding jobs that have to resist extreme high temperature and for cladding steels or stainless steels to obtain a high temperature resistant surface against oxidation. Cladding against high temperature, radiant heater tubes, furnace rolls, muffles in bright annealing furnaces (H2 atmosphere), rotary kilns, waste gas components, hydrogen production, methanol and ammonia synthesis, 2.4633, NiCr25FeAlY, Microfer 6025 HT
CEWELD SA Nicro 625 strip	18274: S Ni 6625 (NiCr22Mo9Nb) A 5.14: EQ NiCrMo-3 (UNS N06625) <u>Flux (FL 860 ESHC)</u> 14174: ES A FB 2		C < 0,1 Mn < 0,5 Fe < 5,0 Si < 0,5 Ni ≥ 58 Al < 0,4 Ti < 0,4 Cr 20,0-23,0 Nb 3,2-4,1 Mo 8,0-10,0	SA Nicro 625 strip is developed for both electroslag (ESW) and sub arc (SAW) process. Typical applications include cladding of vessels for the petrochemical, refinery and chemical industries. NiCr 22 Mo 9 Nb (2.4856), NiCr 22 Mo 6 Cu (2.4618), NiCr 22 Mo 7 Cu (2.4619).
CEWELD SA Alloy 825 strip	18274: S Ni 8065 (NiFe30Cr21Mo3Cu3) A 5.14: EQ NiFeCr-1 (UNS N08065) <u>Flux (FL 860 ESHC)</u> 14174: ES A FB 2		C < 0,05 Mn < 1,0 Fe ≥ 22 Si < 0,5 Cu 1,5-3,0 Ni 38,0-46,0 Al < 0,2 Ti 0,6-1,2 Cr 19,5-23,5 Mo 2,5-3,5	SA Alloy 825 strip is a Nickel-Chromium-Molybdenum alloyed strip for cladding overlay applications. Specially designed for cladding lower alloyed parts to obtain a high quality clad layer against corrosion. Designations: 825 (2.4858, UNS N08825), 1.4500, 1.4529, 1.4539, 2.4858, 1.4563, G-X7NiCrM-oCuNb 25 20, X1NiCrMoCuN25 20 6, X1NiCrMoCuN25 20 5, NiCr21Mo, X1NiCrM-oCu 31 27 4, N08926, N08904, ALLOY 825, N08028, UNS N08825.

## 10. CORED WIRE FOR WELDING NON-ALLOYED STEEL

CEWELD SACW 460	9606: FM1 Sect IX QW-432: F-No. 6 <u>Flux (FL 155)</u> 14171-A: S 46 4 FB T3 A 5.17: F8A4-EC-1 5.23: F8A4-EC-G	with FL155 T > 560 MPa Y > 470 MPa E > 25% I ~ 100J (-40 °C) I ~ 80J (-60 °C)	C < 0,05 Si < 0,35 Mn 1,4 -1,85 P < 0,025 S < 0,025	SACW460 is a cored wire for CMn and mild steels with yield strength up to ~460 MPa Typical with FL 155 Flux or FL 160 S355ML-S460ML, S460Q, S460QL, P355GH, P355N-P460N, P355NL2-P460NL2, P355M-P460M, P355ML2-P460ML2, P355Q-P460Q Shipbuilding grades A-E, AH40-FH40
CEWELD SACW 460- 1W	9606: FM1 Sect IX QW-432: F-No. 6 <u>Flux (FL 155)</u> 14171-A: S 46 4 FB T3 / S 4T 4 FB T3 5.23: F8A6-EC-G (1W)	with FL155 T > 560 MPa Y > 470 MPa E > 25% I ~ 100J (-20 °C) I ~ 80J (-40 °C)	C < 0,05 Si < 0,35 Mn 1,4 -1,85 P < 0,025 S < 0,025	SACW460-1W is a cored wire with micro-alloy elements, which enables welding of one side with one layer and layer counter layer with very good quality values. Also available in the variants 2-3W in combination with solid wire. Typical with FL 155 Flux or FL 160 S355ML-S460ML, S460Q, S460QL, P355GH, P355N-P460N, P355NL2-P460NL2, P355M-P460M, P355ML2-P460ML2, P355Q-P460Q Shipbuilding grades A-E, AH40-FH40
CEWELD SACW 500 QT  (Quenched and Tempe- red)	9606: FM1 Sect IX QW-432: F-No. 6 <u>Flux (FL 155)</u> 14171-A: AW S 46 6 FB T3Ni1 SR: S 46 6 FB T3Ni1 5.23: F8A8-EC-G	with FL155 AW T > 570 MPa Y > 520 MPa E > 30% I ~ 120J (-40 °C) I ~ 100J (-60 °C) SR and N T > 570 MPa Y > 520 MPa E > 30% I ~ 120J (-40 °C) I ~ 100J (-60 °C)	C < 0,05 Si < 0,35 Mn 1,4 -1,85 P < 0,025 S < 0,025 Ni < 0,9	SA CW460 QT is a cored wire for Quenched and Tempered (AW: as welded, all weld metal. SR: stress relieved, all weld metal, 620±15 °C (1150±25°F)/1h. N: Normalized. N&A: Normalized & Annealed.) Offers versatility in suitable application, but is particularly useful when residual stress caused by welding must be minimized or eliminated. Maintains good mechanical properties in the as-welded, postweld stress-relieved, and post-weld normalized conditions. Specially formulated to provide very good weld metal toughness and ductility. Non-alloyed, carbon steels, fine grain structural steels 490-550 MPa (70-80 ksi) tensile strength ASTM :A516, A255, A333, A350, A612, A707



TYPE	EN -ISO and ASME -AWS	MECHANICAL PROPERTIES	ANALYSIS	APPLICATION
------	-----------------------	-----------------------	----------	-------------

## 11. CORED WIRE FOR WELDING CREEP RESISTANT STEEL

<b>CEWELD SACW Mo (P1)</b>	9606: FM4 Sect IX QW-432: F-No. 6 <b>Flux (FL 155)</b> 24598-A: S T Mo FB 24598-B: S 55 4 FB TU 1M3 A 5.23: F8A4-ECA1	<b>with FL155</b> T > 570 MPa Y > 490 MPa E > 24% I ~ 120 J (-20 °C) I ~ 80 J (-40 °C) <b>PWHT</b> 675-705 °C / 60min	C < 0,06 Si 0,3-0,50 Mn < 1,0 P/S < 0,015 Mo 0,45 -0,65	<b>SA CW Mo</b> is a <b>cored wire for 0.5%Mo steels, i.e. P1</b> . These steels are commonly used at service temperatures up to 500 °C and for some sub-zero structural applications. <b>The 0.5% alloying</b> improves creep performance compared to <b>CMn</b> steels and sees the alloy being used for boiler, pressure vessel and piping construction. <b>Typical with FL 155 Flux or FL 160</b> <b>S355J0, E335, P285NH, P310GH, S355J0Cu, 16Mo3, P315N - S420N, P315NH - P420NH fine grain structural steels up to S460N/P460N, large-diameter pipes up to L485MB</b>
<b>CEWELD SACW CrMo1 (P11)</b>	9606: FM4 Sect IX QW-432: F-No. 6 <b>Flux (FL 155)</b> 24598-A: S T CrMo1 24598-B: S 55 4 FB TU SU1CM A 5.23: EB2R A 5.23: F8P0-EB2R	<b>with FL155</b> T > 570 MPa Y > 470 MPa E > 22% I ~ 100J (20 °C) I ~ 50J (-20 °C) <b>PWHT</b> 675-705 °C / 60min	C < 0,10 Si 0,05 – 0,25 Mn 0,60 - 1,00 Cr 1,00 - 1,30 Mo 0,45 - 0,65	<b>SACWCrMo1</b> is a <b>cored wire</b> for high temperature creep resistant <b>1.25%Cr-0.5%Mo ferritic steel, i.e. P11/P12</b> . These steels are used for creep resisting applications up to ~550 °C. <b>Typical with FL 155 Flux or FL 160</b> For matching 1.25%Cr-0.5%Mo creep resisting ferritic steels. <b>13CrMo 4-5, 16CrMo 4-4, G-17CrMo 5-5, 24CrMo5, 25CrMo4</b>
<b>CEWELD SACW CrMo2 (P22)</b>	9606: FM4 Sect IX QW-432: F-No. 6 <b>Flux (FL 155)</b> 24598-A: S T Z CrMo2 FB 24598-B: S 62 0 FB TU 1CM A 5.23: F9P2-ECB3-B3	<b>with FL155</b> T > 640 MPa Y > 560 MPa E > 20% I ~ 100J (20 °C) <b>SR</b> 675-705 °C / 60min	C < 0,9 Si 0,05 – 0,3 Mn 0,60 - 1,00 Cr 2,25 - 2,80 Mo 0,90 - 1,10	<b>SACW CrMo2</b> is a <b>cored wire</b> for for high temperature creep resistant <b>2.25%Cr-1%Mo ferritic steel, i.e. P21/P22</b> . These steels are used for creep resisting applications up to ~600 °C. <b>Typical with FL 155 Flux or FL 160</b> For matching 2.25%Cr-1%Mo creep resisting ferritic steels. <b>10CrMo 9-10, 10CrSiMoV 7, G-17CrMo 9-10</b>
<b>CEWELD SACW NiMo (P36)</b>	9606: FM4 Sect IX QW-432: F-No. 6 <b>Flux (FL 155)</b> 24598-A: S T Z FB 24598-B: S 62 4 FB TU G A 5.23: F9P4-ECG-G	<b>with FL155</b> T > 640 MPa Y > 560 MPa E > 20% I ~ 70J (-40°C) <b>SR</b> 675-705°C / 60min	C < 0,08 Si < 0,4 Mn 0,60 - 1,3 Mo < 0,5 Ni < 1,1	<b>SACW NiMo</b> is a <b>cored wire</b> for for high temperature creep resistant <b>0,5%Mo ferritic steel, i.e. P36</b> he have a very crack resistant weld metal due to the protective effect of the slag in combination with low hydrogen content. Suitable for economical processing on heat-resistant Mo steels up to 500 °C operating temperature. <b>Typical with FL 155 Flux</b> For matching P36 / W36 creep resisting ferritic steels. <b>15NiCuMoNb5, 20MnMoNi4-5, 11NiMoV53, 17MnMoV6-4</b>

## 12. CORED WIRE FOR WELDING FINE GRAIN STEEL

<b>CEWELD SACW 550</b>	9606: FM2 Sect IX QW-432: F-No. 6 <b>Flux (FL 155)</b> 26304-A: S 55 6 FB T3Ni1Mo 26304-B: S69A6 FB TUN2M2 5.23: F9A8-ECF1-F1	<b>with FL155</b> T 640-760 MPa Y > 550 MPa E > 20% I ~ 70J (-60 °C)	C < 0,07 Si < 0,4 Mn 0,60 - 1,3 Ni < 1,0 Mo < 0,5	<b>SACW 550</b> is a <b>cored wire for high strength steel</b> . He have a Extremely crack resistant weld metal conditioned by the high-basicity slag in combination with very low hydrogen content. Well suited for the economic joining of fine grain structural steels with yield strength of <b>Rp0,2 &gt; 550 MPa (80 ksi)</b> . As welding flux we recommend our type FL 155. <b>S315(NL1/2) - S550(Q/L/QL1), 15NiCuMoNb5 / WB 36 , 20MnMoNi4-5, 11Ni-MoV53, 17MnMoV6-4, P355T1/T2 - P460NL2, L360 - L550MB, X42, X65, X70, X80</b>
<b>CEWELD SACW 690</b>	9606: FM2 Sect IX QW-432: F-No. 6 <b>Flux (FL 155)</b> 26304-A: S 69 6 FB T3Ni2,5CrMo 26304-B: S76A6 FB TUN5CM3 5.23: F11A8-ECF5-F5	<b>with FL155</b> T 770 - 900 MPa Y > 690 MPa E > 18% I ~ 70J (-60 °C)	C < 0,08 Si 0,10 - 0,50 Mn 1,20 - 1,70 Cr 0,40 - 0,70 Ni 2,20 - 2,60 Mo 0,30 - 0,60	<b>SACW 690</b> is a <b>cored wire for high strength steel</b> . He have a Remarkable crack resistant weld metal in combination with very low hydrogen content. Therefore, suitable for the economic processing of high-strength and low temperature fine grained structural steels. Excellent welding properties in combination <b>with FL 155 high basic flux</b> even in narrow gabs. Excellent wetting properties compare to solid wires that results in a bigger parameter range and improved deposition rate. To obtain optimum mechanical properties the heat input should be kept below <b>E &lt; 15 kJ/cm</b> and interpass temperature between 100 and 150 °C Recommended welding fluxes from our <b>FL155</b> . <b>StE 690.7 TM, L690M, A 715, StE 690 V, S690QL, A 709, A 515, A 517, EstE 690 VA, S690G1QL1, A 514, A 633, A 709 Naxtra 70, Weldox 700, Dilimax, Optim 700 mc plus, S620Q11, S690QL1, S600MC, S700MC, Naxtra 63, Naxtra 70, TStE620, TStE690, Weldox 500, Hardox, L480 - L550, X65, X80, X90, X100, Hardox 400, XAR 400, Dilidur 400, 20MnCr65, 28CrMn43, Oceanfit 100, Oceanfit 690</b>
<b>CEWELD SACW 890</b>	9606: FM2 Sect IX QW-432: F-No. 6 <b>Flux (FL 155)</b> 26304-A: S 89 4 FB T3Ni2,5Cr1Mo 26304-B: S89A6 FB TUN2M2 5.23: ~ F12A8-ECG	<b>with FL155</b> T 940-1180 MPa Y > 890 MPa E > 15% I ~ 55J (-40 °C)	C < 0,08 Si < 0,4 Mn < 1,6 Cr < 1,0 Ni < 2,2 Mo < 0,5	<b>SACW 890</b> is a <b>cored wire for high strength steel</b> . He have a Extremely crack resistant weld metal conditioned by the high-basicity slag in combination with very low hydrogen content. Well suited for the economic joining of fine grain structural steels with yield strength of <b>Rp0,2 ≥ 890 MPa (80 ksi)</b> . To reach the optimal mechanical properties, the energy absorbed per unit length of weld 15 kJ/cm should not be exceeded. The working temperature should be between 100°C (212 °F) and 150°C (302 °F) . As welding flux FL 155 should be used because of its high basicity and low hydrogen content. <b>TM-pipe steels to StE 890 to S890QL1, X120 high-strength fine grain structural steels (low temp) to StE 960 (StE 1100 to 12 mm) to S960QL1 (S1100). ASTM: up to A 714, A 709, A 515, A 517</b>



SAW				
TYPE	EN -ISO and ASME -AWS	MECHANICAL PROPERTIES	ANALYSIS	APPLICATION

## 13. CORED WIRE AGAINST WEAR

CEWELD SACW 350	14700: T Fe2 <b>Flux (FL 155)</b>	HB 325 - 375	C < 1,5 Si < 0,4 Mn < 1,50 Cr < 5,0 Mo 0,4-0,7 Nb < 0,15	<b>SACW 350 is a cored wire</b> for cladding and rebuilding wornout parts. He have <b>325-375 HB</b> . It can use for hardfacing and rebuilding alloy for wornout wheels, rails, tracks, tires, conveyors, crossings, bufferlayers prior to hardfacing. Excelent wear and abrasion resistance against heavy impact and shock, good machinable with carbide tools.
CEWELD SACW 410NiMo	14343-A: S 13 4 14700: T Fe7 A 5.9: ~ 410NiMo <b>Flux (FL 915)</b>	HRC 43-47 SR 525 °C 40-44 SR 550 °C 37-41 SR 575 °C 33-37 SR 600 °C 30-34	C < 0,07 Si < 0,7 Mn < 0,6 Cr 12,0-14,0 Ni 3,7-4,3 Mo 0,9-1,3	<b>SACW 410NiMo is a tubular wire</b> based on a 13% Chromium and 4% Nickel deposit for cladding components against corrosion, heat and wear resistance <b>13% Cr, 4.5% Ni, 0.5% Mo type</b> . <b>SACW 410NiMo</b> is used for welding similar martensitic and martensitic-ferritic steels in different applications, such as hydro turbines. <b>Water and steam turbine parts of the same kind, thermoshock and high heat resistant. 1.4313, 1.4002, (G)X5CrNi(Mo) 13 4, X6CrAl 13, Grade CA 6 NM.</b>
CEWELD SACW 410Ni-MoN	14343-A: S 13 4 14700: ~T Fe7 A 5.9: ~ 410NiMo <b>Flux (FL 915)</b>	HRC 43-47	C < 0,08 Si < 0,3 Mn < 1,0 Cr 12,0-14,0 Ni 3,7-4,5 Mo < 0,5 N ~ 0,10	<b>SACW 410NiMoN is a tubular wire</b> based on a 13% Chromium and 4% Nickel deposit for cladding components against corrosion, heat and wear resistance <b>12% Cr, 4.5% Ni, 0.5% Mo type</b> . <b>Water and steam turbine parts of the same kind, thermoshock and high heat resistant. 1.4313, 1.4002, (G)X5CrNi(Mo) 13 4, X6CrAl 13, Grade CA 6 NM.</b>
CEWELD SACW 410Ni-MoNbV	14343-A: S 13 4 14700: ~T Fe7(8) A 5.9: ~ 410NiMo <b>Flux (FL 915)</b>	HRC 40-44	C < 0,1 Si < 0,7 Mn 1,0-2,0 Cr 11,0-13,5 Ni 3,0-4,0 Mo 1,0-1,5 Nb 2xC V ~ 0,15	<b>SACW 410NiMoNbV is a tubular wire</b> based on a 13% Chromium and 4% Nickel deposit for cladding components against corrosion, heat and wear resistance <b>12% Cr, 4.5% Ni, 0.5% Mo type</b> . <b>Hard facing alloy with excellent thermo shock resistance and increased hardness due to additions of Vanadium and Niobium</b> <b>Water and steam turbine parts of the same kind, thermoshock and high heat resistant. 1.4313, 1.4002, (G)X5CrNi(Mo) 13 4, X6CrAl 13, Grade CA 6 NM.</b>
CEWELD SACW MnCr	14700: T Fe9 A 5.13: EFeMnCr <b>Flux (FL 915)</b>	HB 220-250 <b>Strain hardening</b>  HB ~500	C < 0,5 Si < 0,4 Mn < 16 Cr < 15 Ni < 1,2 Mo < 0,5 V < 0,20	<b>SACW MnCr is a tubular wire</b> based on a Austenitic deposit with strain hardening properties and <b>no limmits in the number of layers</b> . The deposit is non magnetic and can not be flame cut. Extreme resistance to heavy impact loads. The weld deposit offers fair corrosion resistance and has strain hardening properties. This alloy should be applied at highest impact and pressure loads applications. Best to be used with welding flux <b>FL 915</b> .

## 14. SAW / ESW WELDING FLUXES

TYPE	EN -ISO and ASME -AWS	MAIN COMPONENTS		APPLICATION
CEWELD FL 155	14174: SA FB 1 55 AC H5	SiO2+TiO2 CaO+MgO Al2O3+MnO CaF2	~ 15% ~ 40% ~ 20% ~ 25%	<b>FL 155 is a highly basic SAW flux</b> with low hydrogen content. <b>Basicity:</b> About 3,4 (according to Boniszewski) <b>Current:</b> DC or AC, in single or multi-wires <b>Grain size:</b> 2-16
CEWELD FL 160	14174: SA FB 1 55 AC H5	SiO2+TiO2 CaO+MgO Al2O3+MnO CaF2	~ 15% ~ 40% ~ 20% ~ 20%	<b>FL 160 is a highly basic SAW flux</b> with low hydrogen content. <b>Basicity:</b> about 3 (according to Boniszewski) <b>Current:</b> DC or AC, in single or multi-wires <b>Grain size:</b> 2-20
CEWELD FL 180	14174: SA AR 1 76 AC H5	SiO2+TiO2 CaO+MgO Al2O3+MnO CaF2	~ 25% ~ 5% ~ 55% ~ 10%	<b>FL 180 is an agglomerated rutile flux</b> with Mn and Si pick-up, suitable for carbon steel welding with two or three passes. <b>Basicity:</b> about 0,4 (according to Boniszewski) <b>Current:</b> DC or AC, in single or multi-wires <b>Grain size:</b> 2-20
CEWELD FL 188	14174: SA AB 1 67 AC H5	SiO2+TiO2 CaO+MgO Al2O3+MnO CaF2	~ 20% ~ 35% ~ 30% ~ 10%	<b>FL 188 is an agglomerated rutile flux</b> with Mn and Si pick-up, suitable for carbon steel welding with two or three passes. <b>Basicity:</b> about 1,7 (according to Boniszewski) <b>Current:</b> DC or AC, in single or multi-wires <b>Grain size:</b> 2-16
CEWELD FL 400	14174: SA CS 3 C0,2 Cr3 AC	CaO +MgO SiO2+TiO2 Al2O3+MnO CaF2~10	~ 25% ~ 35% ~ 15% ~ 10%	<b>FL 400 is an agglomerated flux</b> for SAW welding to obtain increased hardness with low and un-alloyed sub arc wires. <b>Basicity:</b> about 1,1 (according to Boniszewski) <b>Current:</b> DC or AC, in single or multi-wires <b>Grain size:</b> 2-16
CEWELD FL 805	14174: SA AF 2 5644 DC	CaO +MgO SiO2+TiO2 Al2O3+MnO CaF2	~ 5% ~ 10% ~ 35% ~ 50%	<b>FL 805 is an agglomerated flux</b> for SAW welding <b>stainless steels</b> and Nickel based alloys: AISI 2205, Alloy 625, 904L <b>Basicity:</b> About 1,7 (according to Boniszewski) <b>Current:</b> DC or AC, in single or multi-wires <b>Grain size:</b> 2-16
CEWELD FL 8111	14174: SA FB 1 65 AC H5	CaO+MgO SiO2+TiO2 Al2O3 + MnO CaF2	~ 35% ~ 20% ~ 25% ~ 15%	<b>FL 8111 is a fluoride basic agglomerated flux</b> for <b>stainless steel</b> SAW welding. <b>Basicity:</b> about 2,6 (according to Boniszewski) <b>Current:</b> DC or AC, in single or multi-wires. <b>Grain size:</b> 2-28

TYPE	EN -ISO and ASME -AWS	MAIN COMPONENTS		APPLICATION
CEWELD FL 830 ESHC	14174: ES A FB 2B 5644 DC	CaO +MgO SiO <sub>2</sub> +TiO <sub>2</sub> CaF <sub>2</sub>	~ 5% ~ 20% ~ 70%	FL 830 ESHC is a <b>highly basic</b> flux for <b>stainless steel strip</b> electro slag cladding. <b>Basicity:</b> about 4,0 (according to Boniszewski) <b>Current:</b> DC + <b>Grain size:</b> 2-16
CEWELD FL 838	14174: SAAF 2 5644 DC H5	CaO +MgO SiO <sub>2</sub> +TiO <sub>2</sub> Al <sub>2</sub> O <sub>3</sub> +MnO CaF <sub>2</sub>	~ 5% ~ 10% ~ 35% ~ 50%	FL 838 is an <b>agglomerated flux</b> for SAW welding <b>stainless steels</b> and Nickel based alloys: AISI 308L, 347, 316L, 309L and 309LN. <b>Basicity:</b> About 1,9 (according to Boniszewski) <b>Current:</b> DC or AC, in single or multi-wires <b>Grain size:</b> 2-16
CEWELD FL 839	14174: SA FB 2 DC	CaO +MgO SiO <sub>2</sub> +TiO <sub>2</sub> Al <sub>2</sub> O <sub>3</sub> +MnO CaF <sub>2</sub>	~ 5% ~ 10% ~ 35% ~ 50%	FL 839 is a <b>highly basic agglomerated welding flux</b> - specially designed for a wide range of nickel alloys. Nickel based welding wires that are covered in AWS A 5.14 such as alloy 82, Inconel 600, 625, 601, 825, C276, alloy 59 etc. <b>Basicity:</b> about 3,3 (according to Boniszewski) <b>Current:</b> DC +, in single or multi-wires <b>Grain size:</b> 2-16
CEWELD FL 851	14174: SAAB 1 67 AC H5	CaO +MgO SiO <sub>2</sub> +TiO <sub>2</sub> Al <sub>2</sub> O <sub>3</sub> +MnO CaF <sub>2</sub>	~ 30% ~ 20% ~ 30% ~ 15%	FL 851 is an <b>agglomerated semi-basic</b> low hydrogen SAW flux. <b>Basicity:</b> about 1,7 (according to Boniszewski) <b>Current:</b> DC or AC, in single or multi-wires <b>Grain size:</b> 2-16
CEWELD FL 860 ESHC	14174: ES A FB 2 5644 DC	CaO +MgO SiO <sub>2</sub> +TiO <sub>2</sub> +Al <sub>2</sub> O <sub>3</sub> CaF <sub>2</sub>	~ 5% ~ 20% ~ 70%	FL 860 ESHC is a <b>highly basic flux</b> for Nickel based strip electro slag cladding. <b>Basicity:</b> about 4,2 (according to Boniszewski) <b>Current:</b> DC + <b>Grain size:</b> 2-16
CEWELD FL 880	14174: SF CS 2 5742 DC	CaO +MgO SiO <sub>2</sub> Al <sub>2</sub> O <sub>3</sub> CaF <sub>2</sub>	~ 35% ~ 30% ~ 5% ~ 20%	FL 880 is a <b>fused flux for SAW welding</b> stainless steels and Nickel based alloys. <b>Basicity:</b> about 1,3 (according to Boniszewski) <b>Current:</b> DC or AC, in single or multi-wires <b>Grain size:</b> 1-16
CEWELD FL 915	14174: SA FB 1 65 AC H5	CaO+MgO SiO <sub>2</sub> +TiO <sub>2</sub> MnO+Al <sub>2</sub> O <sub>3</sub> CaF <sub>2</sub>	~ 35% ~ 20% ~ 25% ~ 15%	FL 915 is an <b>agglomerated high speed basic</b> flux for the SAW process. <b>Basicity:</b> about 2,2 (according to Boniszewski) <b>Current:</b> DC or AC, in single or multi-wires <b>Grain size:</b> 2-28
CEWELD FL CS155	14174: SF CS 1 56 AC H5	CaO+MgO+SiO <sub>2</sub> CaO+MgO	> 50% > 15%	FL CS155 is a <b>fused flux for SAW welding</b> un and low alloyed carbon steels. <b>Basicity:</b> about 1,05 (according to Boniszewski) <b>Current:</b> DC or AC, in single or multi-wires <b>Grain size:</b> 1-16
CEWELD FL CS165	14174: SF CS 1 65 AC H5	CaO +MgO+SiO <sub>2</sub> CaO+MgO	> 55% > 15%	FL CS165 is a <b>fused flux for SAW welding</b> un and low alloyed carbon steels. <b>Basicity:</b> about 1,3 (according to Boniszewski) <b>Current:</b> DC or AC, in single or multi-wires <b>Grain size:</b> 1-16



# 5 - BRAZING



# BRAZING

No.	Group	Page
0	OVERVIEW BRAZING	5/3
BRAZING ALLOYS FOR JOINING		
1	(AB) ARC CuZn BRAZING ALLOYS	5/4
2	(AB) ARC Cu P BRAZING ALLOYS	5/4
3	(AB) ARC Cu P + Ag ( SILVER ALLOYS) BRAZING ALLOYS	5/4-5
4	(AB) ARC Ag ( SILVER ALLOYS) BRAZING ALLOYS	5/5-6
5	SPECIAL BRAZING FLUX	5/6

CLICK HERE FOR EXTENDED SEARCH

SEARCH

**Disclaimer:** Whilst all reasonable efforts have been made to ensure the accuracy of the information contained, the information contained or otherwise referenced herein is presented only as "typical" without guarantee or warranty, and any liability incurred from any reliance thereon is expressly disclaimed. Typical data are those obtained when welded and tested in accordance to prescribed standards, and should not be assumed to be the expected results in a particular application or weldment. Other tests and procedures may produce different results. Users are cautioned to confirm by qualification testing, or other appropriate means, the suitability of any welding consumable and procedure before use in the intended application. The selection and use of specific products is solely within the control of, and remains the sole responsibility of the customer. The right to change design and/or specifications without notice is reserved.



Overview - **BRAZING**

No.	Product Name	ISO	ASME	FM Group	F-Number:	Page
<b>1.(AB) ARC CuZn BRAZING ALLOYS</b>						
1	CEWELD CuZn39Sn	17672: Cu681 1044: CU 306 3677: B-Cu59Zn(Sn)(Ni)(Mn)(Si)-870/890	A 5.8: RB CuZn-C UNS: C68100	-	F-No. 106	5/4
2	CEWELD CuZn40F	17672: Cu 470 1044: CU 301 3677: B-Cu60Zn(Sn)(Si)-875/895	A 5.8: RB CuZn-A UNS: C47000	-	F-No. 106	5/4
3	CEWELD CuZn40G	17672: Cu 470 1044: CU 301 3677: B-Cu60Zn(Sn)(Si)-875/895	A 5.8: RB CuZn-A UNS: C47000	-	F-No. 106	5/4
4	CEWELD CuNi10Zn42	17672: Cu 773 1044: CU 305 3677: B-Cu48ZnNi(Si)-890/920	A 5.8: RB CuZn-D UNS: C77300	-	F-No. 106	5/4
5	CEWELD CuNi10ZnF	17672: Cu 773 1044: CU 305 3677: B-Cu48ZnNi(Si)-890/920	A 5.8: RB CuZn-D UNS: C77300	-	F-No. 106	5/4
<b>2. (AB) ARC Cu P BRAZING ALLOYS</b>						
6	CEWELD L-CuP7	17672: CuP 181 1044: ~ CP202 3677: B-Cu93P-710/793	A 5.8: BCuP-2 UNS: C55181	-	F-No. 103	5/4
7	CEWELD L-CuP7 Sn7	17672: CuP 385 3677: B-Cu87PSnSi-635/675	A 5.8: BCuP-9 UNS: C55385	-	F-No. 103	5/4
<b>3.(AB) ARC Cu P + Ag BRAZING ALLOYS</b>						
8	CEWELD L-Ag2P	17672: CuP 279 1044: CP 105 3677: B-Cu92PAg-645/825	A 5.8: ~UNS: C55279	-	-	5/4
9	CEWELD L-Ag5P	17672: CuP 281 1044: CP 104 3677: B-Cu89PAg-645/815	A 5.8: BCuP-3 UNS: C55281	-	F-No. 103	5/4
10	CEWELD L-Ag15P	17672: CuP 284 1044: CP 102 3677: B-Cu80AgP-645/800	A 5.8: BCuP-5 UNS: C55284	-	F-No. 103	5/4
11	CEWELD L-Ag18P	17672: CuP 286 1044: CP 101 3677: B-Cu75AgP-645	A 5.8: ~UNS: C55385	-	F-No. 103	5/5
12	CEWELD L-Ag18PL	17672: CuP 285 3677: B-Cu76AgP-643/666	A 5.8: BCuP-8 UNS: C55385	-	F-No. 103	5/5
<b>4.(AB) ARC Ag SILVER BRAZING</b>						
13	CEWELD L-Ag20	17672: Ag 220 1044: AG 206 3677: B-Cu 44ZnAg(Si)-690/810	-	-	F-No. 103	5/5
14	CEWELD L-Ag20Cd	17672: ~ Ag 220 (+Cd) 1044: AG 309 3677: B-Cu 40ZnAgCd-605/765	-	-	-	5/5
15	CEWELD L-Ag27	17672: Ag 427 1044: AG 503 3677: B-Cu38AgZnMnNi-680/830	A 5.8: ~UNS: P07427	-	-	5/5
16	CEWELD L-Ag30Sn	17672: Ag 130 1044: AG 105 3677: B-Cu36ZnAgSn-665/755	A 5.8: ~UNS: P07130	-	-	5/5
17	CEWELD L-Ag34Sn	17672: Ag 134 1044: AG 106 3677: B-Cu36AgZnSn-630/730	A 5.8: ~UNS: P07130	-	-	5/5
18	CEWELD L-Ag40Sn	17672: Ag 140 1044: AG 105 3677: B-Ag40CuZnSn-650/710	A 5.8: BAg-28 UNS: P07401	-	F-No. 102	5/5
19	CEWELD L-Ag45Sn	17672: Ag 145 1044: AG 104 3677: B-Ag45CuZnSn-640/680	A 5.8: BAg-36 UNS: P07145	-	F-No. 102	5/5
20	CEWELD L-Ag49NiMn	17672: Ag 449 1044: AG 502 3677: B-Ag49ZnCuMnNi-680/705	A 5.8: BAg-22 UNS: P07490	-	F-No. 101	5/5
21	CEWELD L-Ag55Sn	17672: Ag156 1044: AG 103 3677: B-Ag55ZnCuSn-630/660	A 5.8: BAg-7 UNS: P07155	-	F-No. 102	5/6
22	CEWELD L-Ag60Sn	17672: Ag160 1044: AG 402 3677: B-Ag60CuSn-600/730	A 5.8: BAg-18 UNS: P07600	-	F-No. 102	5/6
<b>5. SPECIAL BRAZING FLUX</b>						
23	CEWELD FL Gas-Flux	1045: FH 21	-	-	-	5/6
24	CEWELD Super-Flux	1045: FH10	A 5.31: FB3-F	-	-	5/6
25	CEWELD Universal-Flux	1045: FH10	A 5.31: FB3-F	-	-	5/6
26	CEWELD Alu-Flux	1045: FL 10	-	-	-	5/6

## BRAZING

TYPE	EN -ISO and ASME -AWS	MECHANICAL PROPERTIES	ANALYSIS	APPLICATION
------	-----------------------	-----------------------	----------	-------------

## 1. (AB) ARC CuZn BRAZING ALLOYS

<b>CEWELD CuZn39Sn</b>	<b>Sect IX QB-432:</b> F-No. 106 <b>17672:</b> Cu681 <b>3677:</b> B-Cu59Zn(Sn)(Ni)(Mn)(Si)-870/890 <b>1044:</b> CU 306 <b>A 5.8:</b> RB CuZn-C <b>UNS:</b> C68100	T > 400 MPa  <b>Melting range</b> 870 - 890 °C	Cu 56,0 - 60,0 Zn Rest Sn 0,8 - 1,1 Si 0,04 - 0,15 Mn 0,01 - 0,50 Ni 0,2 - 0,8 Fe 0,25 - 1,2	<b>CuZn39Sn</b> is a <b>solid brazing wire</b> for Steels, Copper, Cast iron, Copper alloys, Nickel and for welding Brass and Bronze. This alloy is mainly used in the furniture and the bicycle industry for joining steels, also this alloy can be used for rebuilding Brass- ship propellers by flame welding.
<b>CEWELD CuZn40F</b>	<b>Sect IX QB-432:</b> F-No. 106 <b>17672:</b> Cu 470 <b>3677:</b> B-Cu60Zn(Sn)(Si)-875/895 <b>1044:</b> CU 301 <b>A 5.8:</b> RB CuZn-A <b>UNS:</b> C47000	T > 350 MPa  <b>Melting range</b> 875 - 895 °C	Cu 57,0 - 61,0 Zn Rest Sn 0,25 - 0,5	<b>CuZn40F</b> is a flux-coated <b>brazing rod</b> for Steels, Copper, Cast iron, Copper alloys, Nickel and for welding Brass and Bronze. This alloy is mainly used in the furniture and the bicycle industry for joining steels, also this alloy can be used for rebuilding Brass- ship propellers by flame welding.
<b>CEWELD CuZn40G</b>	<b>Sect IX QB-432:</b> F-No. 106 <b>17672:</b> Cu 470 <b>3677:</b> B-Cu60Zn(Sn)(Si)-875/895 <b>1044:</b> CU 301 <b>A 5.8:</b> RB CuZn-A <b>UNS:</b> C47000	T > 350 MPa  <b>Melting range</b> 875 - 895 °C	Cu 57,0 - 61,0 Zn Rest Sn 0,25 - 0,5	<b>CuZn40G</b> is a <b>flux-cored brazing rod</b> for Steels, Copper, Cast iron, Copper alloys, Nickel and for welding Brass and Bronze. This alloy is mainly used in the furniture and the bicycle industry for joining steels, also this alloy can be used for rebuilding Brass- ship propellers by flame welding.
<b>CEWELD CuNi10Zn42</b>	<b>Sect IX QB-432:</b> F-No. 106 <b>17672:</b> Cu 773 <b>3677:</b> B-Cu48ZnN- i(Si)-890/920 <b>1044:</b> CU 305 <b>A 5.8:</b> RB CuZn-D <b>UNS:</b> C77300	T > 785 MPa HB 180  <b>Melting range</b> 890 - 920 °C	Cu 46,0 - 50,0 Zn Rest Si 0,04 - 0,2 Ni 9,0 - 11,0	<b>CuNi10Zn42</b> is a <b>solid brazing wire</b> for Steels, Galvanized steel, Tempered Cast Iron, Cast iron, Nickel alloys etc.. This alloy is mainly used in the furniture and the bicycle industry for <b>high strength joining</b> of steels, also is this alloy recommended for rebuilding cock wheels due to the good sliding properties.
<b>CEWELD CuNi10ZnF</b>	<b>Sect IX QB-432:</b> F-No. 106 <b>17672:</b> Cu 773 <b>3677:</b> B-Cu48ZnN- i(Si)-890/920 <b>1044:</b> CU 305 <b>A 5.8:</b> RB CuZn-D <b>UNS:</b> C77300	T > 800 MPa HB 180  <b>Melting range</b> 890 - 920 °C	Cu 46,0 - 50,0 Zn Rest Si 0,04 - 0,2 Ni 9,0 - 11,0	<b>CuNi10ZnF</b> is a <b>flux coated brazing rod</b> for Steels, Galvanized steel, Tempered Cast Iron, Cast iron, Nickel alloys etc.. This alloy is mainly used in the furniture and the bicycle industry for <b>high strength joining</b> of steels, also is this alloy recommended for rebuilding cock wheels due to the good sliding and wear properties.

## 2. (AB) ARC Cu P BRAZING ALLOYS

<b>CEWELD L-CuP7</b>	<b>Sect IX QB-432:</b> F-No. 103 <b>17672:</b> CuP 181 <b>3677:</b> B-Cu93P-710/793 <b>1044:</b> ~ CP202 <b>A 5.8:</b> BCuP-2 <b>UNS:</b> C55181	T > 250 MPa  <b>Melting range</b> 710 - 820 °C <b>Brazing Temp.</b> 730 °C	Cu Rest P 7,0 - 7,5	<b>L-CuP7</b> is a <b>solid brazing rod</b> for Joining: <b>Copper to copper</b> , Copper alloys, Brass, <b>Copper-Sn alloys</b> with flux. Do not use this alloy above working temperatures of 200°C.
<b>CEWELD L-CuP7 Sn7</b>	<b>Sect IX QB-432:</b> F-No. 103 <b>17672:</b> CuP 385 <b>3677:</b> B-Cu- 87PsnSi-635/675 <b>1044:</b> - - - <b>A 5.8:</b> BCuP-9 <b>UNS:</b> C55385	T > 250 MPa  <b>Melting range</b> 635 - 675 °C <b>Brazing Temp.</b> 645 °C	Cu Rest P 6,0 - 7,0 Sn 6,0 - 7,0 Si 0,01 - 0,4	<b>L-CuP7 Sn7</b> is a <b>solid brazing rod</b> for Joining: <b>Copper to copper</b> , Copper alloys, Brass, <b>Copper-Sn alloys</b> with flux. Do not use this alloy above working temperatures of 200°C.

## 3. (AB) ARC Cu P + Ag BRAZING ALLOYS

<b>CEWELD L-Ag2P</b>	<b>Sect IX QB-432:</b> F-No. - - - <b>17672:</b> CuP 279 <b>3677:</b> B-Cu92PAg-645/825 <b>1044:</b> CP 105 <b>A 5.8:</b> - - - <b>UNS:</b> C55279	T > 250 MPa  <b>Melting range</b> 645 - 825 °C <b>Brazing Temp.</b> 740 °C	Cu Rest P 5,9 - 6,7 Ag 1,5 - 2,5	<b>L-Ag2P</b> is a <b>Copper-phosphor solder</b> with a low silver content for <b>copper to copper</b> (without flux), Brass, copper and <b>copper-tin alloys</b> (with flux). This solder has a very good gap filling capacity and is particularly suitable for bridging wide gaps. For gap soldering on copper, brass, bronze and gunmetal. Solder filler material suitable for operating <b>temperatures between - 60 °C and +150 °C</b> , <b>Do not use in sulfur-containing media</b> and not with Fe and Ni-based alloys.
<b>CEWELD L-Ag5P</b>	<b>Sect IX QB-432:</b> F-No. 103 <b>17672:</b> CuP 281 <b>3677:</b> B-Cu89PAg-645/815 <b>1044:</b> CP 104 <b>A 5.8:</b> BCuP-3 <b>UNS:</b> C55281	T > 250 MPa  <b>Melting range</b> 645 - 815 °C <b>Brazing Temp.</b> 710 °C	Cu Rest P 5,8 - 6,2 Ag 4,8 - 5,2	<b>L-Ag5P</b> is a <b>Silver-containing copper-phosphorus solder</b> for <b>copper to copper</b> (without flux), Brass, copper and <b>copper-tin alloys</b> (with flux), with good flowing properties and high ductility. For gap soldering on copper, brass, tin bronze and gunmetal. For solder joints with operating <b>temperatures between - 60 °C and +150 °C</b> . <b>Do not use with sulfur-containing media and not with Fe and Ni-based alloys.</b>
<b>CEWELD L-Ag15P</b>	<b>Sect IX QB-432:</b> F-No. 103 <b>17672:</b> CuP 284 <b>3677:</b> B-Cu80AgP-645/800 <b>1044:</b> CP 102 <b>A 5.8:</b> BCuP-5 <b>UNS:</b> C55284	T > 250 MPa  <b>Melting range</b> 645 - 800 °C <b>Brazing Temp.</b> 700 °C	Cu Rest P 4,8 - 5,2 Ag 14,5 - 15,5	<b>L-Ag15P</b> is a <b>solid brazing wire</b> for <b>copper to copper</b> (without flux), Brass, copper and <b>copper-tin alloys</b> (with flux). <b>Low-viscosity</b> , with good flowing properties and high ductility, even at low temperatures. For gap soldering in connection with strong <b>thermal alternating loads</b> and vibrations. For solder joints with operating temperatures between -70 °C and +150 °C. Do not use with sulfur-containing media and not with Fe and Ni-based alloys.

TYPE	EN -ISO and ASME -AWS	MECHANICAL PROPERTIES	ANALYSIS	APPLICATION
CEWELD L-Ag18P	Sect IX QB-432: F-No. --- 17672: CuP 286 3677: B-Cu75AgP-645 1044: CP 101 A 5.8: --- UNS: C55385	T > 250 MPa  Melting range 645 °C Brazing Temp. 650 °C	Cu Rest P 6,6 - 6,7 Ag 17,0 - 19,0	L-Ag18P is an eutectic alloy for <b>copper to copper</b> (without flux). Brass, copper and <b>copper-tin alloys</b> (with flux). and is <b>particularly recommended for sanitary</b> and refrigerating installations, boilers, heat exchangers, tubing etc. Especially recommended for applications that require lowest operating temperature with highest strength and very short melting range. <b>Do not use in a sulphurous environment.</b> Suitable for working temperatures up to 200 °C.
CEWELD L-Ag18PL	Sect IX QB-432: F-No. 103 17672: CuP 285 3677: B-Cu76AgP-643/666 1044: --- A 5.8: BCuP-8 UNS: C55385	T > 250 MPa  Melting range 643 - 666 °C Brazing Temp. 670 °C	Cu Rest P 6,0 - 6,7 Ag 17,2-18,0	L-Ag18PL is a <b>solid brazing wire for copper to copper</b> (without flux). Brass, copper and <b>copper-tin alloys</b> (with flux). and is <b>particularly recommended for sanitary</b> and refrigerating installations, boilers, heat exchangers, tubing etc. <b>Do not use in a sulphurous environment.</b> For working temperatures up to 200 °C.
<b>4. (AB) ARC Ag SILVER BRAZING</b>				
CEWELD L-Ag20	Sect IX QB-432: F-No. --- 17672: Ag 220 3677: B-Cu 44ZnAg(Si)-690/810 1044: AG 206 A 5.8: --- UNS: ---	T: 380 - 450 MPa  Melting range 690 - 810 °C Brazing Temp. 810 °C	Ag 19,0 - 21,0 Cu 43,0 - 45,0 Zn 34,0 - 38,0 Si 0,05 - 0,25	L-Ag20 is a <b>Silver-containing, superheat-resistant silver solder</b> alloy without Cadmium for gap and joint soldering of alloyed and unalloyed steel, nickel and nickel alloys, malleable iron, copper and copper alloys and hard metals. When brass is soldered, the colors are largely the same. The silicon in the solder can lower the mechanical quality values when brazing carbon steels. <b>Suitable for solder joints with operating temperatures up to 300 °C.</b>
CEWELD L-Ag20Cd	Sect IX QB-432: F-No. --- 17672: ~ Ag 220 (+Cd) 3677: B-Cu 40ZnAgCd-605/765 1044: AG 309 A 5.8: --- UNS: ---	T: 350 - 430 MPa  Melting range 605 - 765 °C Brazing Temp. 750 °C	Ag 19,0 - 21,0 Cu 39,0 - 43,0 Zn 23,0 - 27,0 Cd 13,0 - 17,0	L-Ag20Cd is a <b>Silver-containing, superheat-resistant silver solder</b> alloy with Cadmium for gap and joint soldering of alloyed and unalloyed steel, nickel and nickel alloys, malleable iron, copper and copper alloys and hard metals. When brass is soldered, the colors are largely the same. The silicon in the solder can lower the mechanical quality values when brazing carbon steels. <b>Suitable for solder joints with operating temperatures up to 300 °C.</b>
CEWELD L-Ag27	Sect IX QB-432: F-No. --- 17672: Ag 427 3677: B-Cu38AgZn- MnNi-680/830 1044: AG 503 A 5.8: --- UNS: P07427	T: 150 - 300 MPa  Melting range 680 - 830 °C Brazing Temp. 830 °C	Ag 26,0 - 28,0 Cu 37,0 - 39,0 Zn 18,0 - 22,0 Mn 8,5 - 10,5 Ni 5,0 - 6,0 Si < 0,05	L-Ag27 is a Very good flowing, low-melting silver hard solder for operating temperatures from -200 °C to Max. 200 °C (without loss of strength). Typical base materials: hard metals and materials that are difficult to wet, such as tungsten, molybdenum, tantalum and chrome.
CEWELD L-Ag30Sn	Sect IX QB-432: F-No. --- 17672: Ag 130 3677: B-Cu36Zn- nAgSn-665/755 1044: AG 107 A 5.8: --- UNS: P07130	T: 360 - 480 MPa  Melting range 665 - 755 °C Brazing Temp. 750 °C	Ag 29,0 - 31,0 Cu 35,0 - 37,0 Zn 30,0 - 34,0 Sn 1,5 - 2,5	L-Ag30Sn is for brazing a <b>weight range of different metals</b> in maintenance and repair with excellent strength, Boiler making, tubing, cooling equipment etc. The presence of tin improves the fluidity and is useful to increase the activity of the flux. <b>Do not use this alloy above working temperatures of 200 °C.</b>
CEWELD L-Ag34Sn	Sect IX QB-432: F-No. --- 17672: Ag 134 3677: B-Cu- 36AgZnSn-630/730 1044: AG 106 A 5.8: --- UNS: P07130	T: 360 - 480 MPa  Melting range 630 - 730 °C Brazing Temp. 710 °C	Ag 33,0 - 35,0 Cu 33,0 - 37,0 Zn 25,5 - 29,5 Sn 2,0 - 3,0	L-Ag34Sn is for brazing Steels, Copper, Copper alloys, Stainless steel, Nickel and Nickel alloys. <b>Also suitable for dissimilar joints between these metals.</b>
CEWELD L-Ag40Sn	Sect IX QB-432: F-No. 102 17672: Ag 140 3677: B-Ag- 40CuZnSn-650/710 1044: AG 105 A 5.8: BAg-28 UNS: P07401	T: 360 - 480 MPa  Melting range 650 - 710 °C Brazing Temp. 690 °C	Ag 39,0 - 41,0 Cu 29,0 - 31,0 Zn 26,0 - 30,0 Sn 1,5 - 2,5	L-Ag40Sn is for brazing a <b>weight range of different metals</b> in maintenance and repair with excellent strength, Boiler making, tubing, cooling equipment etc. Do not use this alloy above working temperatures of 200 °C.
CEWELD L-Ag45Sn	Sect IX QB-432: F-No. 102 17672: Ag 145 3677: B-Ag- 45CuZnSn-640/680 1044: AG 104 A 5.8: BAg-36 UNS: P07145	T: 350 - 430 MPa  Melting range 640 - 680 °C Brazing Temp. 670 °C	Ag 44,0 - 46,0 Cu 26,0 - 28,0 Zn 23,5 - 27,5 Sn 2,0 - 3,0	L-Ag45Sn is for brazing a weight range of different metals in maintenance and repair with excellent strength, Boiler making, tubing, cooling equipment etc. Do not use this alloy above working temperatures of 200 °C. It is the most <b>universal silver brazing alloy</b> without cadmium with extreme low operating temperature and high mechanical properties. Due to the addition of Sn. this alloy will show a bright looking joint and is more capillary than the standard silver brazing alloys.

## BRAZING

TYPE	EN -ISO and ASME -AWS	MECHANICAL PROPERTIES	ANALYSIS	APPLICATION
<b>CEWELD L-Ag49NiMn</b>	<b>Sect IX QB-432:</b> F-No. 101 <b>17672:</b> Ag 449 <b>3677:</b> B-Ag49ZnCuMnNi-680/705 <b>1044:</b> AG 502 <b>A 5.8:</b> BAg-22 <b>UNS:</b> P07490	T: 150 - 300 MPa  <b>Melting range</b> 680 - 705 °C <b>Brazing Temp.</b> 830 °C	Ag 48,0 - 50,0 Cu 15,0 - 17,0 Zn 21,0 - 25,0 Ni 4,0 - 5,0 Mn 7,0 - 8,0	<b>L-Ag49niMn</b> is a Very good flowing, low-melting silver hard solder for operating temperatures from -200 °C to Max. 200°C (without loss of strength). Typical base materials: Hard metal and materials that are difficult to wet, such as tungsten, molybdenum, tantalum and chrome.
<b>CEWELD L-Ag55Sn</b>	<b>Sect IX QB-432:</b> F-No. 102 <b>17672:</b> Ag156 <b>3677:</b> B-Ag55ZnCuSn-630/660 <b>1044:</b> AG 103 <b>A 5.8:</b> BAg-7 <b>UNS:</b> P07155	T: 330 - 430 MPa  <b>Melting range</b> 620 - 655 °C <b>Brazing Temp.</b> 670 °C	Ag 55,0 - 57,0 Cu 21,0 - 23,0 Zn 15,0 - 19,0 Sn 4,5 - 5,5	<b>L-Ag55Sn</b> is for Joining: Steels, Cast iron, Copper, Copper alloys, Stainless steel, Nickel and Nickel alloys. <b>High silver containing universal silver brazing</b> alloy without cadmium with low operating temperature and high mechanical properties. Due to the addition of Sn. this alloy will show a bright looking joint and <b>is more capillary than the standard silver brazing alloys.</b>
<b>CEWELD L-Ag60Sn</b>	<b>Sect IX QB-432:</b> F-No. 102 <b>17672:</b> Ag160 <b>3677:</b> B-Ag60CuSn-600/730 <b>1044:</b> AG 402 <b>A 5.8:</b> BAg-18 <b>UNS:</b> P07600	T: 390 - 460 MPa  <b>Melting range</b> 600 - 730 °C <b>Brazing Temp.</b> 730 °C	Ag 59,0 - 61,0 Cu 29,0 - 31,0 Sn 9,5 - 10,5	<b>L-Ag60Sn</b> is for joining: Steels, Cast iron, Copper, Copper alloys, Stainless steel, Nickel and Nickel alloys. Also suitable for dissimilar joints between these metals. Do not use this alloy above working temperatures of 200 °C. <b>High silver containing universal silver brazing alloy without cadmium</b> with low operating temperature and high mechanical properties. <b>Due to the addition of Sn</b> this alloy will show a bright looking joint and is more capillary than the standard silver brazing alloys.
<b>5. SPECIAL BRAZING FLUX</b>				
<b>CEWELD Gas-Flux</b>	<b>1045:</b> FH 21			<b>Gas flux</b> (liquid) that comes along with the <b>flame for brazing</b> copper, brass, bronze, steel and galvanised steel. Working range <b>from 750 to 1100 °C.</b>
<b>CEWELD Super-Flux</b>	<b>1045:</b> FH 10 <b>A 5.31:</b> FB3-F			<b>Super-Flux</b> removes oxides and impurities from the surface during the heating process to obtain perfect bonding of the brazing filler metal. Superflux also reduces the surface tension and improves capillarity. After brazing flux residues can easily be removed mechanically or with a caustic soda solution. Flux <b>for silver brazing</b> with a melting range <b>from 450 till 800 °C</b> , for copper, brass, steel and stainless steel.
<b>CEWELD Universal-Flux</b>	<b>1045:</b> FH 10 <b>A 5.31:</b> FB3-F			<b>Universal -Flux</b> for brazing with brass and new <b>silver alloy on copper, copper alloys, brass, steel, galvanised steel</b> , working temperature <b>from 550-800 °C.</b>
<b>CEWELD Alu-Flux</b>	<b>1045:</b> FL 10			Alu-Fux is for brazing from <b>aluminium and aluminium alloys</b> with a working range <b>from 350 to 550 °C.</b> Usualy combined with AISi12 or AISi5 filler metal.







# 6 - THERMAL SPRAY



# THERMAL SPRAY

No.	Group	Page
0	OVERVIEW OF THE PRODUCTS	6/3

## BRAZING RODS FOR JOINTWELDING

1	(THSP) Ni AND Ni ALLOYED WIRE FOR THERMAL SPRAY	6/4
2	(THSP) Al BASE WIRE FOR THERMAL SPRAY	6/4
3	(THSP) Sn AND Sn ALLOY BASE WIRE FOR THERMAL SPRAY	6/4
4	(THSP) Cu AND Cu ALLOY BASE WIRE FOR THERMAL SPRAY	6/4
5	(THSP) LOW ALLOY BASE WIRE FOR THERMAL SPRAY	6/5
6	(THSP) STAINLESS BASE WIRE FOR THERMAL SPRAY	6/5

CLICK HERE FOR EXTENDED SEARCH



**Disclaimer:** Whilst all reasonable efforts have been made to ensure the accuracy of the information contained, the information contained or otherwise referenced herein is presented only as "typical" without guarantee or warranty, and any liability incurred from any reliance thereon is expressly disclaimed. Typical data are those obtained when welded and tested in accordance to prescribed standards, and should not be assumed to be the expected results in a particular application or weldment. Other tests and procedures may produce different results. Users are cautioned to confirm by qualification testing, or other appropriate means, the suitability of any welding consumable and procedure before use in the intended application. The selection and use of specific products is solely within the control of, and remains the sole responsibility of the customer. The right to change design and/or specifications without notice is reserved.

**Certilas Nederland B.V. | Gloxinialaan 2, 6851 TG Huissen, The Netherlands | [info@certilas.com](mailto:info@certilas.com) | [www.certilas.com](http://www.certilas.com) | Rev.2023.**

Overview - **THERMAL SPRAY**

No.	Product Name	ISO	ASME	FM Group	F-Number:	Page
<b>1. (THSP) Ni AND Ni ALLOY WIRES FOR THERMAL SPRAY</b>						
1	CEWELD SP 80/20 NiAl	14919: 6.6 -x.x - 1 (NiAl20)	-	-	-	6/4
2	CEWELD SP 95/5 NiAl	14919: 6.5 -x.x - 1 (NiAl5)	-	-	-	6/4
3	CEWELD SP 80/20 NiCr	14919: 6.4 -x.x - 1 (NiCr20)	-	-	-	6/4
4	CEWELD SP NiTi3	14919: ~ 6.x -x.x - 1 (NiTi3)	-	-	-	6/4
<b>2. (THSP) Al BASE WIRE FOR THERMAL SPRAY</b>						
5	CEWELD SP Al99,0	14919: 3.2 -x.x - 1 (AL99,5)	-	-	-	6/4
<b>3. (THSP) Sn AND Sn ALLOY BASE WIRE FOR THERMAL SPRAY</b>						
6	CEWELD SP <b>Babbits</b>	14919: 1.2 -x.x - 1 (SnSbCu84)	-	-	-	6/4
<b>4. (THSP) Cu AND Cu ALLOY BASE WIRE FOR THERMAL SPRAY</b>						
7	CEWELD SP CuSn6	14919: 4.4 -x.x - 1 (CuSN6)				6/4
<b>5. (THSP) LOW ALLOYED STEEL WIRE FOR THERMAL SPRAY</b>						
7	CEWELD SP 1.0616	14919: 5.3 -x.x - 1 (80MnSi)	-	-	-	6/5
8	CEWELD SP 1.3505	14919: ~ 5.x -x.x - 1 (150Cr4)	-	-	-	6/5
9	CEWELD SP 10Mn	14919: 5.1 -x.x - 1 (10Mn)				6/5
<b>6. (THSP) STAINLESS STEEL WIRES FOR THERMAL SPRAY</b>						
10	CEWELD SP 1.4115	14919: 5.8-x.x - 1 (X20CrMo13-1)	-	-	-	6/5
11	CEWELD SP 1.4122	14919: 5.16.-x.x - 1 (X39CrMo17-1)	-	-	-	6/5
12	CEWELD SP 1.4302	14919: 5.10-x.x - 1 (X6CrNi19-9)	-	-	-	6/5
13	CEWELD SP 1.4370	14919: 5.12-x.x - 1 (X12CrNiMn18-8-6)	-	-	-	6/5
14	CEWELD SP 312	14919: ~5.x-x.x - 1 (X 10 CrNi 30 90)	-	-	-	6/5
15	CEWELD SP 420-B	14919: ~5.x-x.x - 1 (X13Cr)	-	-	-	6/5

Many other types of alloys are possible in this area. Visit our homepage and contact us!

## THERMAL SPRAY

TYPE	EN -ISO and ASME -AWS	MECHANICAL PROPERTIES	ANALYSIS	APPLICATION
------	-----------------------	-----------------------	----------	-------------

## 1. (THSP) Ni AND Ni ALLOY WIRES FOR THERMAL SPRAY

<b>CEWELD SP 80/20 NiAl</b>	14919: 6.6 -x.x - 1 (NiAl20)	75 HRB  <b>Bond Strength</b> 9100 psi (63 MPa)	Ni Rest Al 18,0 - 22,0 Fe < 0,3 Mn < 0,3 Si < 0,5 Cu < 0,1 C < 0,25	<b>SP 80/20 NiAl</b> is widely used as a bond coat for subsequent thermal spray layers and as a one step build up material for dimensional restoration of aircraft engines. <b>SP 80/20 NiAl</b> is a cored wire specifically designed for both, arc spraying and flame spraying. It is self bonding to most materials and requires minimal surface preparation. Bond strengths in excess of <b>9000 psi can be achieved</b> on grit blasted surfaces. <b>SP 80/20 NiAl</b> exhibits good resistance to high temperature oxidation and abrasion, and excellent resistance to impact and bending. <b>SP 80/20 NiAl</b> can be machined and ground to a finish of 5 micro inches.
<b>CEWELD SP 95/5 NiAl</b>	149196: 6.5 -x.x - 1 (NiAl5)	75 HRB  <b>Bond Strength</b> 10000 psi (69 MPa)	Ni Rest Al 5,0 - 5,5 Si 1,0 - 1,7 Mn < 0,3 Ti < 0,4 Fe < 0,3 Cu < 0,08 C < 0,005	<b>SP 95/5 NiAl</b> is a Nickel-Aluminum based alloy for use as a bonding layer with the thermal spray process. This alloy offers the highest bonding properties available for both the Flame spray process as the Arc Spray process. The wire has a high polished and clean surface to assure the best feeding and thermal spray properties. Sprayed layers of this material are-resistant to variation in high temperatures and are used as a buffer layer for all other spraying alloys. Hardness, <b>coating macro: approximately HRC 22. Maximum working temperature: approximately 850 °C.</b>
<b>CEWELD SP 80/20 NiCr</b>	14919: 6.4 -x.x - 1 (NiCr20)	90 HRB  <b>Bond Strength</b> 7300 psi (50 MPa)	Ni Rest Cr 18,0 - 21,0 Cu < 0,5 C < 0,25 Fe < 0,5 Mn < 1,2 Si < 0,5 S < 0,015	<b>SP 80/20 NiCr</b> is a <b>nickel-chromium</b> electrical-resistance alloy for use at <b>operating temperatures up to 1150 °C</b> . It contains rare-earth additions for increased oxidation resistance, especially under conditions of frequent switching or wide temperature fluctuations. The alloy has a low temperature coefficient of resistance, making it suitable for control resistors. Used for heating elements in domestic appliances and industrial equipment. Excellently suitable as a buffer layer before finishing with ceramic layers.
<b>CEWELD SP NiTi3</b>	14919: ~ 6.x -x.x - 1 (NiTi3)	<b>Bond Strength</b> ~ 7300 psi (50 MPa)	Ni Rest Ti 2,0 - 3,5 Mn < 1,0 Fe < 1,0 Al < 1,5 Si < 0,7 Cu < 0,2	<b>SP NiTi-3</b> is an electrically resistant nickel-titanium alloy for use at operating at operating temperatures up to 800°C. For bonding coatings when high bonding strength is required, recommended as bonding layer for ceramic coatings. Resistant to corrosion and alkaline environments.

## 2. (THSP) Al BASE WIRE FOR THERMAL SPRAY

<b>CEWELD SP Al99,0</b>	14919: 3.2 -x.x - 1 (AL99,5)	65 HRB  <b>Bond Strength</b> 4300 psi (30 MPa)	Al 99,5 Si < 0,25 Fe < 0,4 Ti < 0,02 Cu < 0,02 Zn < 0,07 Mn < 0,02	<b>SP Al 99,0</b> is a pure grade aluminium wire for thermal spray applications. Aluminum wire coatings are recommended for cathodic corrosion protection in atmospheric and salt / fresh water immersion, with application areas such as oil refining equipment, chemical processing equipment, boat bottom interiors exposed to bilge water and other similar types of exposure.
-------------------------	------------------------------	---	--	--

## 3. (THSP) Sn AND Sn ALLOY BASE WIRE FOR THERMAL SPRAY

<b>CEWELD SP Babbitts</b>	14919: 1.2 -x.x - 1 (SnSbCu84)	65 HRB  <b>Bond Strength</b> 3000 psi (20 MPa)	Sn Rest Sb 7,0 - 8,0 Cu 3,0 - 4,0 Pb < 0,35 As < 0,1 Bi < 0,08 Fe < 0,1 Al < 0,01 Zn < 0,01	<b>SP Babbitts</b> is a high tin, lead free Babbitts wire specifically designed for spraying in arc spray and flame spray systems. It produces dense, well-bonded coatings particularly applicable to high speed and heavy duty bearings.
---------------------------	--------------------------------	---	---	---

## 4. (THSP) Cu AND Cu ALLOY BASE WIRE FOR THERMAL SPRAY

<b>CEWELD SP CuSn6</b>	14919: 4.4 -x.x - 1 (CuSn6)	80 HRB	Sn 5,0 - 8,0 Cu Rest Fe < 0,1 Al < 0,01 Zn < 0,1 Pb < 0,02 P 0,01 - 0,4	<b>Sp CuSn6</b> is a Bronze metal spray wire for coatings that require good sliding properties
------------------------	-----------------------------	--------	---	--



TYPE	EN -ISO and ASME -AWS	MECHANICAL PROPERTIES	ANALYSIS	APPLICATION
<b>5. (THSP) LOW ALLOYED STEEL WIRE FOR THERMAL SPRAY</b>				
<b>CEWELD SP 1.0616</b>	<b>14919:</b> 5.3 -x.x - 1 (80MnSi)	50 - 60 HRC	Fe Rest C 0,80 - 0,85 Mn 0,50 - 0,70 Si 0,15 - 0,35	<b>SP 1.0616</b> is copper coated solid thermal spray wire for coatings with high hardness.. Extremely hard, wear resistant high carbon alloy with excellent lubricating and sliding properties even at elevated temperatures.
<b>CEWELD SP 1.3505</b>	<b>14919:</b> ~ 5.x -x.x - 1 (150Cr4)	47 - 52 HRC	Fe Rest C ~ 1,0 Mn ~ 0,30 Si ~ 0,25 Cr ~ 1,5	<b>SP 1.3505</b> is solid thermal spray wire for coatings with high hardness and excellent bonding strength. Recommended for Cylinder surfaces in automotive industry, and other engine parts that are exposed to severe wear and thermal impact . The high carbon content creates excellent lubricating and sliding properties .
<b>CEWELD SP 10Mn</b>	<b>14919:</b> 5.1 -x.x - 1 (C10Mn)		Fe Rest C 0,04 - 0,12 Mn 0,42 - 0,68 Si ~ 0,05	<b>SP 10Mn</b> can be applied by the arc and flame spray processes and offers remarkable adhesion and excellent lubricating properties.
<b>6. (THSP) STAINLESS STEEL WIRES FOR THERMAL SPRAY</b>				
<b>CEWELD SP 1.4115</b>	<b>14919:</b> 5.8-x.x - 1 (X20CrMo13-1)  ~ <b>14700:</b> S Fe 7	~45 HRc	Fe Rest C 0,17-0,22 Mn < 1,0 Si < 1,0 Cr 12 - 14 Ni < 1,0	<b>SP 1.4115</b> is solid metal spray wire that combines high toughness with very good corrosion resistance, shiny coating The spray deposit cannot be machined with normal cutting tools, grinding is possible. Hardness approximately <b>45 HRc</b> .
<b>CEWELD SP 1.4122</b>	<b>14919:</b> 5.16-x.x - 1 (X39CrMo17-1)	~50 HRc	Fe Rest C 0,33-0,45 Mn < 1,50 Si < 1,0 Cr 15,5 -17,5 Ni ~ 0,9 Mo 0,80 - 1,30	<b>SP 1.4122</b> is Solid spray wire that combines high toughness with very good corrosion resistance, shiny coating with a little higher hardness than <b>SP 1.4122</b> . The spray deposit cannot be machined with normal cutting tools, grinding is possible. Hardness approximately <b>50 HRc</b> .
<b>CEWELD SP 1.4302</b>	<b>14919:</b> 5.10-x.x - 1 (X6CrNi19-9) ~ <b>A5.9:</b> ER 308	200 - 230 HB	Fe Rest C < 0,06 Mn < 2,0 Si < 1,5 Cr 18,0 - 20,0 Ni 8,5 - 10,5	<b>SP 1.4302</b> is Solid spray wire he exhibit good corrosion resistance against organic and non-oxidizing liquids and are recommend for internal and external diameters. Using the combustion wire spray process, <b>SP 1.4302</b> should be sprayed thinner than <b>SP 1.4370</b> and <b>SP 420-B</b> coatings.
<b>CEWELD SP 1.4370</b>	<b>14919:</b> 5.12-x.x - 1 (X12CrNiMn18-8-6)  ~ <b>A 5.9:</b> ~ER307Si	200 - 400 HB	Fe Rest C < 0,20 Mn 5,5 - 8,0 Si < 1,0 Cr 17,0 - 20,0 Ni 7,5 - 9,5	<b>SP 1.4370</b> is Solid spray wire he exhibit low shrink and are recommend for internal diameters, particularly where thick coatings are needed. Using the combustion wire spray process, <b>SP 1.4370</b> coatings can be sprayed thicker than <b>SP 1.4316</b> coatings, but not as thick as <b>SP 420-B</b> coating.
<b>CEWELD SP 312</b>	<b>14919:</b> ~5.x-x.x - 1 (X 10 CrNi 30 90)  ~ <b>A5.9:</b> ER 312	200-220 HB	Fe Rest C < 0,15 Mn < 1,0 - 2,5 Si < 0,3 -0,65 Cr 28,0 -32,0 Ni 8,0 - 10,0 Mo < 0,75	<b>SP 312</b> is a Chromium- Nickel alloy for use at operating temperatures <b>up to 1020 °C</b> . It contains a high chromium content for good corrosion resistance and remarkable strength properties, especially under conditions of frequent switching or wide temperature fluctuations. Used for heating elements in domestic appliances and industrial equipment. <b>SP 312</b> can be applied with the flame spray process and the electric arc process as well.
<b>CEWELD SP 420-B</b>	<b>14919:</b> ~5.x-x.x - 1 (X13Cr)	47 - 52 HRC	C 0,25 - 0,40 Mn < 0,6 Si < 0,5 Cr 12,0 - 14,0 Ni < 0,6	<b>SP 420-B</b> can be processed by both the flame spraying and the electric arc and offers extremely stable arc properties. Their chemically cleaned surface ensures excellent conveying properties.



# 7 - CERTILAS WELDING KNOW-HOW



# WELDING KNOW-HOW

No.		Page
1	ISO STANDARDS	7/6-90
2	ASME STANDARDS	7/91-158
3	TYPES OF CERTIFICATES	7/159
4	MECHANICAL TESTING OF WELD METAL	7/160-164
5	STORAGE AND HANDLING	7/165
6	NOTES ON THE WELDER EXAMINATION ACCORDING TO EN ISO 9606	7/166-170
7	NOTES ON THE WELDER EXAMINATION ACCORDING TO AWS	7/171-175
8	DESIGNATION OF STEELS ACCORDING TO ISO	7/176-181
9	SOURCES OF HYDROGEN DURING WELDING	7/182-185
10	PACKAGING	7/186-191
11	ELECTRODE CAST AND HELIX ISO 544 AND AWS	7/192
12	WELDING POSITIONS ISO VS. AWS	7/193-194
13	WELDING GUN ANGLE	7/195-199
14	DEPOSITION RATES ISO VS. AWS	7/200-201
15	COMMON DEFINITIONS FROM THE WORLD OF WELDING	7/202-204
16	SELECTION OF WELDING METHODS / PROCESSES AND THEIR CLASSIFICATION NUMBERS ISO 4063	7/205
17	COMMON ACRONYMS FROM THE WORLD OF WELDING	7/206-207

[CLICK HERE FOR EXTENDED SEARCH](#)



**Disclaimer:** Whilst all reasonable efforts have been made to ensure the accuracy of the information contained, the information contained or otherwise referenced herein is presented only as "typical" without guarantee or warranty, and any liability incurred from any reliance thereon is expressly disclaimed. Typical data are those obtained when welded and tested in accordance to prescribed standards, and should not be assumed to be the expected results in a particular application or weldment. Other tests and procedures may produce different results. Users are cautioned to confirm by qualification testing, or other appropriate means, the suitability of any welding consumable and procedure before use in the intended application. The selection and use of specific products is solely within the control of, and remains the sole responsibility of the customer. The right to change design and/or specifications without notice is reserved.

Overview - **WELDING KNOW-HOW**

No.	ISO-Standard	Titel	Page
<b>ISO-NORMEN</b>			
1	ISO 636	RODS, WIRES AND DEPOSITS FOR TUNGSTEN INERT GAS WELDING OF NON-ALLOY AND FINE-GRAIN STEELS	7/6 - 7
2	ISO 1071	COVERED ELECTRODES, WIRES, RODS AND TUBULAR CORED ELECTRODES FOR FUSION WELDING OF CAST IRON	7/8 - 9
3	ISO 2560	COVERED ELECTRODES FOR MANUAL METAL ARC WELDING OF NON-ALLOY AND FINE GRAIN STEELS	7/10 - 11
4	ISO 3580	COVERED ELECTRODES FOR MANUAL METAL ARC WELDING OF CREEP-RESISTING STEELS	7/12 - 13
5	ISO 3581	COVERED ELECTRODES FOR MANUAL METAL ARC WELDING OF STAINLESS AND HEAT-RESISTING STEELS	7/14
6	ISO 6848	ARC WELDING AND CUTTING - NONCONSUMABLE TUNGSTEN ELECTRODES	7/15
7	ISO 12153	TUBULAR CORED ELECTRODES FOR GAS SHIELDED AND NON-GAS SHIELDED METAL ARC WELDING OF NICKEL AND NICKEL ALLOYS	7/16 - 17
8	ISO 14171	SOLID WIRE ELECTRODES, TUBULAR CORED ELECTRODES AND ELECTRODE/FLUX COMBINATIONS FOR SUBMERGED ARC WELDING OF NON ALLOY AND FINE GRAIN STEELS	7/18 - 22
9	ISO 14172	COVERED ELECTRODES FOR MANUAL METAL ARC WELDING OF NICKEL AND NICKEL ALLOYS	7/23 - 24
10	ISO 14174	FLUXES FOR SUBMERGED ARC WELDING AND ELECTROSLAG WELDING	7/25
11	ISO 14175	GASES AND GAS MIXTURES FOR FUSION WELDING AND ALLIED PROCESSES	7/26
12	ISO 14341	WIRE ELECTRODES AND WELD DEPOSITS FOR GAS SHIELDED METAL ARC WELDING OF NON ALLOY AND FINE GRAIN STEELS	7/27 - 28
13	ISO 14343	WIRE ELECTRODES, STRIP ELECTRODES, WIRES AND RODS FOR ARC WELDING OF STAINLESS AND HEAT RESISTING STEELS	7/29 - 33
14	EN 14700	WELDING CONSUMABLES FOR HARD-FACING	7/34 - 35
15	ISO 14919	THERMAL SPRAYING - WIRES, RODS AND CORDS FOR FLAME AND ARC SPRAYING	7/36 - 43
16	ISO 16834	WIRE ELECTRODES, WIRES, RODS AND DEPOSITS FOR GAS SHIELDED ARC WELDING OF HIGH STRENGTH STEELS	7/44 - 46
17	ISO 17632	TUBULAR CORED ELECTRODES FOR GAS SHIELDED AND NON-GAS SHIELDED METAL ARC WELDING OF NON-ALLOY AND FINE GRAIN STEELS	7/47 - 49
18	ISO 17633	TUBULAR CORED ELECTRODES AND RODS FOR GAS SHIELDED AND NON-GAS SHIELDED METAL ARC WELDING OF STAINLESS AND HEAT-RESISTING STEELS	7/50 - 53
19	ISO 17634	TUBULAR CORED ELECTRODES FOR GAS SHIELDED METAL ARC WELDING OF CREEP-RESISTING STEELS	7/54 - 57
20	ISO 17672	BRAZING — FILLER METALS	7/58 - 67
21	ISO 17777	COVERED ELECTRODES FOR MANUAL METAL ARC WELDING OF COPPER AND COPPER ALLOYS	7/68 - 69
22	ISO 18273	WIRE ELECTRODES, WIRES AND RODS FOR WELDING OF ALUMINIUM AND ALUMINIUM ALLOYS	7/70
23	ISO 18274	WIRE AND STRIP ELECTRODES, WIRES AND RODS FOR FUSION WELDING OF NICKEL AND NICKEL ALLOYS	7/71 - 72
24	ISO 18275	COVERED ELECTRODES FOR MANUAL METAL ARC WELDING OF HIGH-STRENGTH STEELS	7/73 - 74
25	ISO 18276	TUBULAR CORED ELECTRODES FOR GAS-SHIELDED AND NON-GAS-SHIELDED METAL ARC WELDING OF HIGH STRENGTH STEELS	7/75 - 76
26	ISO 20378	RODS FOR GAS WELDING OF NON-ALLOY AND CREEP-RESISTING STEELS	7/77
27	ISO 21952	WIRES ELECTRODES, WIRES, RODS AND DEPOSITS FOR GAS-SHIELDED ARC WELDING OF CREEP-RESISTING STEELS	7/78 - 80
28	ISO 24034	SOLID WIRES AND RODS FOR FUSION WELDING OF TITANIUM AND TITANIUM ALLOYS	7/81
29	ISO 24373	SOLID WIRES AND RODS FOR FUSION WELDING OF COPPER AND COPPER ALLOYS	7/82
30	ISO 24598	SOLID WIRE ELECTRODES, TUBULAR CORED ELECTRODES AND ELECTRODE-FLUX COMBINATIONS FOR SUBMERGED ARC WELDING OF CREEP-RESISTING STEELS	7/83- 86
31	ISO 26304	SOLID WIRE ELECTRODES, TUBULAR CORED ELECTRODES AND ELECTRODE-FLUX COMBINATIONS FOR SUBMERGED ARC WELDING OF HIGH STRENGTH STEELS	7/87 - 89
32	DIN 2302	COVERED ELECTRODES FOR MANUAL METAL ARC WELDING OF NON-ALLOY AND FINE GRAIN STEELS IN A WET HYPERBARIC ENVIRONMENT	7/90

# WELDING KNOW-HOW - Overview

No.	ASW-Normen	Part C Specifications for Welding Rods, Electrodes, and Filler Metals	Page
<b>AWS-NORMEN</b>			
1	AWS A5.1	SPECIFICATION FOR CARBON STEEL ELECTRODES FOR SHIELDED METAL ARC WELDING	7/91 - 93
2	AWS A5.2	SPECIFICATION FOR CARBON AND LOW-ALLOY STEEL RODS FOR OXYFUEL GAS WELDING	7/94
3	AWS A5.3	SPECIFICATION FOR ALUMINUM AND ALUMINUM-ALLOY ELECTRODES FOR SHIELDED METAL ARC WELDING	7/95
4	AWS A5.4	SPECIFICATION FOR STAINLESS STEEL ELECTRODES FOR SHIELDED METAL ARC WELDING	7/96 - 97
5	AWS A5.5	SPECIFICATION FOR LOW-ALLOY STEEL ELECTRODES FOR SHIELDED METAL ARC WELDING	7/98 - 101
6	AWS A5.6	SPECIFICATION FOR COPPER AND COPPER-ALLOY ELECTRODES FOR SHIELDED METAL ARC WELDING	7/102 - 103
7	AWS A5.7	SPECIFICATION FOR COPPER AND COPPER-ALLOY BARE WELDING RODS AND ELECTRODES	7/102 - 103
8	AWS A5.8	SPECIFICATION FOR FILLER METALS FOR BRAZING AND BRAZE WELDING	7/104 - 108
9	AWS A5.9	SPECIFICATION FOR BARE STAINLESS STEEL WELDING ELECTRODES AND RODS	7/109 - 113
10	AWS A5.10	SPECIFICATION FOR BARE ALUMINUM AND ALUMINUM-ALLOY WELDING ELECTRODES AND RODS	7/114
11	AWS A5.11	SPECIFICATION FOR NICKEL AND NICKEL-ALLOY WELDING ELECTRODES FOR SHIELDED METAL ARC WELDING	7/115 - 116
12	AWS A5.12	SPECIFICATION FOR TUNGSTEN AND OXIDE DISPERSED TUNGSTEN ELECTRODES FOR ARC WELDING AND CUTTING	7/117
13	AWS A5.13	SPECIFICATION FOR SURFACING ELECTRODES FOR SHIELDED METAL ARC WELDING	7/118
14	AWS A5.14	SPECIFICATION FOR NICKEL AND NICKEL-ALLOY BARE WELDING ELECTRODES AND RODS	7/119 - 120
15	AWS A5.15	SPECIFICATION FOR WELDING ELECTRODES AND RODS FOR CAST IRON	7/121
16	AWS A5.16	SPECIFICATION FOR TITANIUM AND TITANIUM-ALLOY WELDING ELECTRODES AND RODS	7/122
17	AWS A5.17	SPECIFICATION FOR CARBON STEEL ELECTRODES AND FLUXES FOR SUBMERGED ARC WELDING	7/123
18	AWS A5.18	SPECIFICATION FOR CARBON STEEL ELECTRODES AND RODS FOR GAS SHIELDED ARC WELDING	7/124
19	AWS A5.20	SPECIFICATION FOR CARBON STEEL ELECTRODES FOR FLUX CORED ARC WELDING	7/125 - 126
20	AWS A5.21	SPECIFICATION FOR BARE ELECTRODES AND RODS FOR SURFACING	7/127 - 129
21	AWS A5.22	SPECIFICATION FOR STAINLESS STEEL ELECTRODES FOR FLUX CORED ARC WELDING AND STAINLESS STEEL FLUX CORED RODS FOR GAS TUNGSTEN ARC WELDING	7/130 - 133
22	AWS A5.23	SPECIFICATION FOR LOW-ALLOY STEEL ELECTRODES AND FLUXES FOR SUBMERGED ARC WELDING	7/134 - 136
23	AWS A5.24	SPECIFICATION FOR ZIRCONIUM AND ZIRCONIUM-ALLOY WELDING ELECTRODES AND RODS	7/137
24	AWS A5.25	SPECIFICATION FOR CARBON AND LOW-ALLOY STEEL ELECTRODES AND FLUXES FOR ELECTROSLAG WELDING	7/138
25	AWS A5.26	SPECIFICATION FOR CARBON AND LOW-ALLOY STEEL ELECTRODES FOR ELECTROGAS WELDING	7/139
26	AWS A5.28	SPECIFICATION FOR LOW-ALLOY STEEL ELECTRODES AND RODS FOR GAS SHIELDED ARC WELDING	7/140 - 142
27	AWS A5.29	SPECIFICATION FOR LOW-ALLOY STEEL ELECTRODES FOR FLUX CORED ARC WELDING	7/143 - 146
28	AWS A5.31	SPECIFICATION FOR FLUXES FOR BRAZING AND BRAZE WELDING	7/147
29	AWS A5.32	SPECIFICATION FOR WELDING SHIELDING GASES	7/148
30	AWS A5.34	SPECIFICATION FOR NICKEL-ALLOY ELECTRODES FOR FLUX CORED ARC WELDING	7/149 - 150
31	AWS A5.35	SPECIFICATION FOR ELECTRODES FOR UNDERWATER WET SHIELDED METAL ARC WELDING	7/151 - 152
32	AWS A5.36	SPECIFICATION FOR CARBON AND LOW-ALLOY STEEL FLUX CORED ELECTRODES FOR FLUX CORED ARC WELDING AND METAL CORED	7/153 - 157
33	ALL	AWS WELDING FILLER MATERIAL SPECIFICATIONS OVERVIEW CLASSIFIED BY MATERIAL AND WELDING PROCESS	7/158





GUIDE TO EN ISO 636-A: RODS, WIRES AND DEPOSITS FOR TUNGSTEN INERT GAS WELDING OF NON-ALLOY AND FINE-GRAIN STEELS

W = Welding process type – gas tungsten arc welding

**W 46 3 3Si1**

Symbol	Tensile Strength MPa	Yield Strength min. MPa	Elongation min. %
38	470-600	380	20
42	500-640	420	20
46	530-680	460	20
50	560-720	500	18

Symbol	Impact Energy Charpy-V Temp °C for 47J min.
Z	No requirements
A	20
0	0
2	-20
3	-30
4	-40
5	-50
6	-60
7	-70
8	-80
9	-90
10	-100

Symbol	Chemical composition, mass % a),b)										
	C	Si	Mn	P	S	Ni	Cr	Mo	V	Al	Ti+Zr
0	Any other defined requirements										
2Si	0,06 - 0,14	0,50 - 0,80	0,90 - 1,30	0,025	0,025	0,15	0,15	0,15	0,03	0,02	0,15
3Si1	0,06 - 0,14	0,70 - 1,00	1,30 - 1,60	0,025	0,025	0,15	0,15	0,15	0,03	0,02	0,15
4Si1	0,06 - 0,14	0,80 - 1,20	1,60 - 1,90	0,025	0,025	0,15	0,15	0,15	0,03	0,02	0,15
2Ti	0,04 - 0,14	0,40 - 0,80	0,90 - 1,40	0,025	0,025	0,15	0,15	0,15	0,03	0,05 - 0,20	0,05 - 0,25
3Ni1	0,06 - 0,14	0,50 - 0,90	1,00 - 1,60	0,020	0,020	0,80 - 1,50	0,15	0,15	0,03	0,02	0,15
2Ni2	0,06 - 0,14	0,40 - 0,80	0,80 - 1,40	0,020	0,020	2,10 - 2,70	0,15	0,15	0,03	0,02	0,15
2Mo	0,08 - 0,12	0,30 - 0,70	0,90 - 1,30	0,020	0,020	0,15	0,15	0,40 - 0,60	0,03	0,02	0,15

a) Single values shown in the table are maximum values.

b) The results shall be rounded to the same number of significant figures as in the specified value using the rule A in accordance with Annex B of ISO 31-0:1992.

## GUIDE TO EN ISO 636-B: RODS, WIRES AND DEPOSITS FOR TUNGSTEN INERT GAS WELDING OF NON-ALLOY AND FINE-GRAIN STEELS

Symbol a)	Minimum yield strength b) MPa	Tensile strength MPa	Minimum elongation c) %
43X	330	430 - 600	20
49X	390	490 - 670	18
55X	460	550 - 740	17
57X	490	570 - 770	17

a) Instead of X: "A" - values from testing in as-welded condition  
"P" - values from testing in heat-treatment condition.  
b) For yield strength the yield, ReL, is used when yielding occurs, otherwise the 0,2 % proof strength, Rp0,2, is used.  
c) Gauge length is equal to five times the test specimen diameter.

Symbol	Impact Energy Charpy-V Temp °C for 47J min.
Z	No requirements
A	20
0	0
2	-20
3	-30
4	-40
5	-50
6	-60
7	-70
8	-80
9	-90
10	-100

W = Welding process type –  
gas tungsten arc welding

**W 55A 6 3**

Symbol	Chemical composition, mass %											
	C	Si	Mn	P	S	Ni	Cr	Mo	V	Cu	Al	Ti+Zr
Z	Any other defined requirements											
2	0,07	0,40 - 0,70	0,90 - 1,40	0,025	0,035	—	—	—	—	0,50	0,05 - 0,15	Ti: 0,05 - 0,15 Ti: 0,02 - 0,12
3	0,06 - 0,15	0,45 - 0,75	0,90 - 1,40	0,025	0,035	—	—	—	—	0,50	—	—
4	0,07 - 0,15	0,65 - 0,85	1,00 - 1,50	0,025	0,035	—	—	—	—	0,50	—	—
6	0,06 - 0,15	0,80 - 1,15	1,40 - 1,85	0,025	0,035	—	—	—	—	0,50	—	—
12	0,02 - 0,15	0,55 - 0,10	1,25 - 1,90	0,030	0,030	—	—	—	—	0,50	—	—
16	0,02 - 0,15	0,40 - 1,00	0,90 - 1,60	0,030	0,030	—	—	—	—	0,50	—	—
1M3	0,12	0,30 - 0,70	1,30	0,025	0,025	0,020	—	0,40 - 0,65	—	0,35	—	—
2M3	0,12	0,30 - 0,70	0,60 - 1,40	0,025	0,025	—	—	0,40 - 0,65	—	0,50	—	—
2M31	0,12	0,30 - 0,90	0,80 - 1,50	0,025	0,025	—	—	0,40 - 0,65	—	0,50	—	—
2M32	0,05	0,30 - 0,90	0,80 - 1,40	0,025	0,025	—	—	0,40 - 0,65	—	0,50	—	—
3M1T	0,12	0,40 - 1,00	1,40 - 2,10	0,025	0,025	—	—	0,10 - 0,45	—	0,50	—	Ti: 0,02 - 0,30
3M3	0,12	0,60 - 0,90	1,10 - 1,60	0,025	0,025	—	—	0,40 - 0,65	—	0,50	—	—
4M3	0,12	0,30	1,50 - 2,00	0,025	0,025	—	—	0,40 - 0,65	—	0,50	—	—
4M31	0,05 - 0,15	0,50 - 0,80	1,60 - 2,10	0,025	0,025	—	—	0,40 - 0,65	—	0,50	—	—
4M3T	0,12	0,50 - 0,80	1,60 - 2,20	0,025	0,025	—	—	0,40 - 0,65	—	0,50	—	Ti: 0,02 - 0,30
N1	0,12	0,20 - 0,50	1,25	0,025	0,025	0,60 - 1,00	—	0,35	—	0,35	—	—
N2	0,12	0,40 - 0,80	1,25	0,025	0,025	0,80 - 1,10	0,15	0,35	0,05	0,35	—	—
N3	0,12	0,30 - 0,80	1,20 - 1,60	0,025	0,025	1,50 - 1,90	—	0,35	—	0,35	—	—
N5	0,12	0,40 - 0,80	1,25	0,025	0,025	2,00 - 2,75	—	—	—	0,35	—	—
N7	0,12	0,20 - 0,50	1,25	0,025	0,025	3,00 - 3,75	—	0,35	—	0,35	—	—
N71	0,12	0,40 - 0,80	1,25	0,025	0,025	3,00 - 3,75	—	—	—	0,35	—	—
N9	0,10	0,50	1,40	0,025	0,025	4,00 - 4,75	—	0,35	—	0,35	—	—
NCC	0,12	0,60 - 0,90	1,00 - 1,65	0,030	0,030	0,10 - 0,30	0,50 - 0,80	—	—	0,20 - 0,60	—	—
NCC1	0,12	0,20 - 0,40	0,40 - 0,70	0,030	0,030	0,50 - 0,80	0,50 - 0,80	—	—	0,30 - 0,75	—	—
NCCT	0,12	0,60 - 0,90	1,00 - 1,65	0,030	0,030	0,10 - 0,30	0,50 - 0,80	—	—	0,20 - 0,60	—	Ti: 0,02 - 0,30
NCCT1	0,12	0,50 - 0,80	1,20 - 1,80	0,030	0,030	0,10 - 0,40	0,50 - 0,80	0,02 - 0,30	—	0,20 - 0,60	—	Ti: 0,02 - 0,30
NCCT2	0,12	0,50 - 0,90	1,10 - 1,70	0,030	0,030	0,40 - 0,80	0,50 - 0,80	—	—	0,20 - 0,60	—	Ti: 0,02 - 0,30
N1M2T	0,12	0,60 - 1,00	1,70 - 2,30	0,025	0,025	0,40 - 0,80	—	0,20 - 0,60	—	0,50	—	Ti: 0,02 - 0,30
N1M3	0,12	0,20 - 0,80	1,10 - 1,90	0,025	0,025	0,30 - 0,90	—	0,40 - 0,65	—	0,50	—	—
N2M3	0,12	0,30	1,10 - 1,60	0,025	0,025	0,80 - 1,20	—	0,40 - 0,65	—	0,50	—	—
NCC1	0,12	0,20 - 0,40	0,40 - 0,70	0,030	0,030	0,50 - 0,80	0,50 - 0,80	—	—	0,30 - 0,75	—	—
NCCT	0,12	0,60 - 0,90	1,00 - 1,65	0,030	0,030	0,10 - 0,30	0,50 - 0,80	—	—	0,20 - 0,60	—	Ti: 0,02 - 0,30
NCCT1	0,12	0,50 - 0,80	1,20 - 1,80	0,030	0,030	0,10 - 0,40	0,50 - 0,80	0,02 - 0,30	—	0,20 - 0,60	—	Ti: 0,02 - 0,30
NCCT2	0,12	0,50 - 0,90	1,10 - 1,70	0,030	0,030	0,40 - 0,80	0,50 - 0,80	—	—	0,20 - 0,60	—	Ti: 0,02 - 0,30
N1M2T	0,12	0,60 - 1,00	1,70 - 2,30	0,025	0,025	0,40 - 0,80	—	0,20 - 0,60	—	0,50	—	Ti: 0,02 - 0,30
N1M3	0,12	0,20 - 0,80	1,10 - 1,90	0,025	0,025	0,30 - 0,90	—	0,40 - 0,65	—	0,50	—	—
N2M3	0,12	0,30	1,10 - 1,60	0,025	0,025	0,80 - 1,20	—	0,40 - 0,65	—	0,50	—	—

GUIDE TO EN ISO 1071: COVERED ELECTRODES, WIRES, RODS AND TUBULAR CORED ELECTRODES FOR FUSION WELDING OF CAST IRON

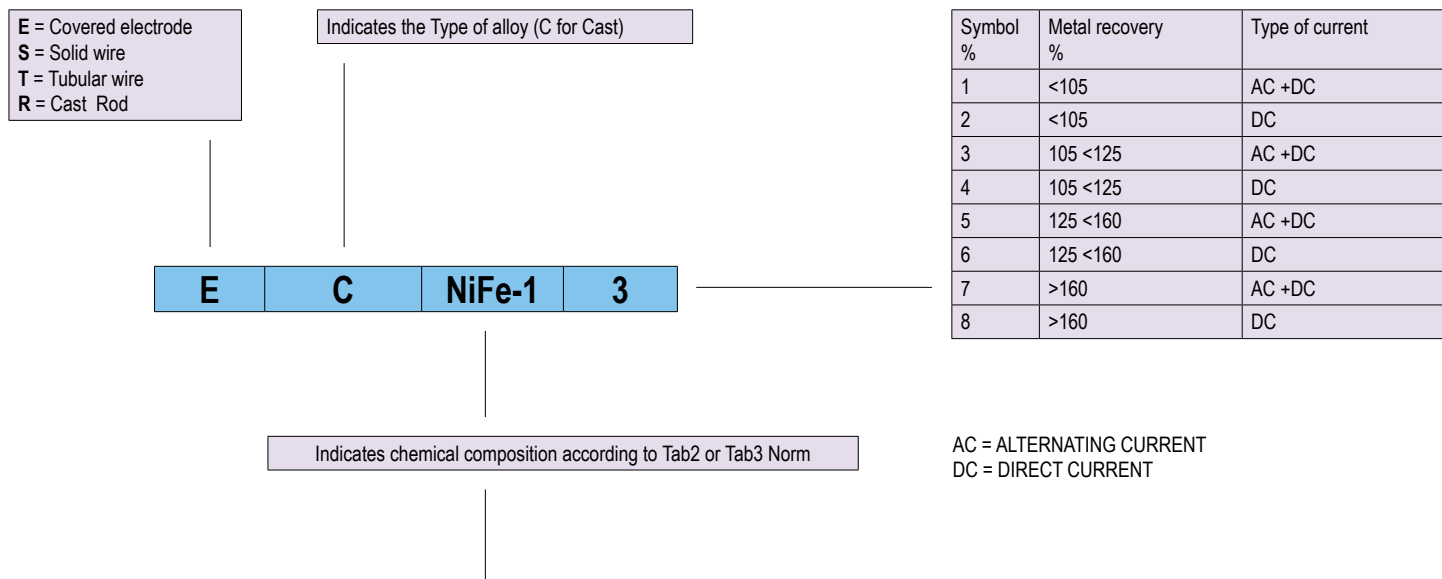

Tab 2 . Chemical composition of similar all-weldmetal

Symbol	Typ	C	Si	Mn	P	S	Fe	Ni	Cu	Remark	Other max.
FeC1	E,R	3,0-3,6	2,0-3,5	0,8	0,5	0,1	Rest	-	-	Al: 3,0	1,0
FeC2	E,T	3,0-3,6	2,0-3,5	0,8	0,5	0,1	Rest	-	-	Al: 3,0	1,0
FeC3	E,T	2,5-5,0	2,5-9,5	1,0	0,2	0,04	Rest	-	-	-	1,0
FeC4	R	3,2-3,5	2,7-3,0	0,60-0,75	0,50-0,75	0,10	Rest	-	-	-	1,0
FeC5	R	3,2-3,5	2,0-2,5	0,50-0,70	0,20-0,40	0,10	Rest	1,20-1,60	-	Mo:0,25-0,45	1,0
FeC-GF	E,T	3,0-4,0	2,0-3,7	0,6	0,05	0,015	Rest	1,5	-	Mg:0,2-0,1 Ca0,20	1,0
FeC-GP1	R	3,2-3,5	3,2-3,8	0,1-0,4	0,05	0,015	Rest	0,50	-	Mg:0,2-0,1 Ca0,20	1,0
FeC-GP2	E,T	2,5-3,5	1,5-3,5	1,0	0,05	0,015	Rest	2,5	1,0	Mg:0,2-0,1 Ca0,20	1,0
Z	R,E,T	Any other agreed composition									

## GUIDE TO EN ISO 1071: COVERED ELECTRODES, WIRES, RODS AND TUBULAR CORED ELECTRODES FOR FUSION WELDING OF CAST IRON

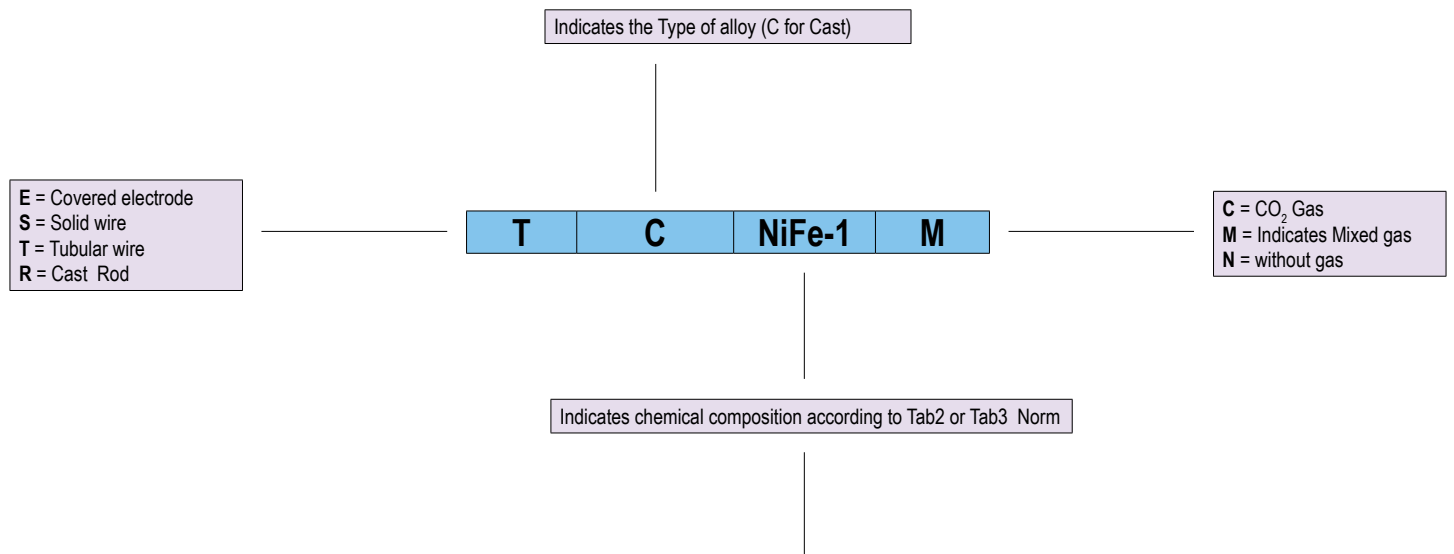

Tab 3 Chemical composition of dissimilar all-weldmetal											
Symbol	Typ	C	SI	Mn	P	S	Fe	Ni	Cu	Remark	Other max.
Fe-1	E,S,T	2,0	1,5	0,5-1,5	0,04	0,04	Rest	-	-	-	1,0
St	E,S,T	0,15	1,0	0,8	0,04	0,04	Rest	-	0,35	-	0,35
Fe-2	E,T	0,2	1,5	0,3-1,5	0,04	0,04	Rest	-	-	Nb+V:5,0-10,0	1,0
Ni-CI	E	2,0	4,0	2,5	-	0,03	8,0	min 85	2,5	Al: 1,0	1,0
	S	1,0	0,75	2,5	-	0,03	4,0	min 90	4,0	-	1,0
Ni-CI-A	E	2,0	4,0	2,5	-	0,03	8,0	min 85	2,5	Al: 1,0-3,0	1,0
NiFe-1	E,S,T	2,0	4,0	2,5	0,03	0,03	Rest	45-75	4,0	Al: 1,0	1,0
NiFe-2	E,S,T	2,0	4,0	1,0-5,0	0,03	0,03	Rest	45-60	2,5	Al: 1,0 carbid elements: 3,0	1,0
NiFe-CI	E	2,0	4,0	2,5	-	0,04	Rest	40-60	2,5	Al: 1,0	1,0
NiFeT3-CI	T	2,0	1,0	3,0-5,0	-	0,03	Rest	45-60	2,5	Al: 1,0	1,0
NiFe-CI-A	E	2,0	4,0	2,5	-	0,03	Rest	45-60	2,5	Al: 1,0-3,0	1,0
NiFeMn-CI	E	2,0	1,0	10-14	-	0,03	Rest	35-45	2,5	Al: 1,0	1,0
	S	0,5	1,0	10-14	-	0,03	Rest	35-45	2,5	Al: 1,0	1,0
NiCu	E,S	1,7	1,0	2,5	-	0,04	5,0	50-75	Rest	-	1,0
NiCu-A	E,S	0,35-0,55	0,75	2,3	-	0,025	3,0-6,0	50-60	35-45	-	1,0
NiCu-B	E,S	0,35-0,55	0,75	2,3	-	0,025	3,0-6,0	60-70	25-35	-	1,0
Z	E,S,T	Any other agreed composition									

GUIDE TO EN ISO 2560-A: COVERED ELECTRODES FOR MANUAL METAL ARC WELDING OF NON-ALLOY AND FINE GRAIN STEELS

Symbol	Tensile Strength	Yield Strength	Elongation
	MPa	min. MPa	min. %
38	470-600	380	20
42	500-640	420	20
46	530-680	460	20
50	560-720	500	18

Symbol	Welding Position
1	PA, PB, PC, PD, PE, PF & PG
2	PA, PB, PC, PD, PE PF
3	PA & PB,
4	PA
5	PA, PB & PG

PA = Flat position  
 PB = Horizontal-vertical position  
 PC = Transverse position  
 PD = Horizontal overhead position  
 PE = Overhead position  
 PF = Vertical up position  
 PG = Vertical down position

**E 46 3 1Ni B 5 4 H5**

E = Covered electrode for manual metal arc welding

Symbol	Hydrogen content, ml/100 g deposited weld metal, max.
H5	5
H10	10
H15	15

Symbol	Impact Energy Charpy-V Temp °C for 47J min.
Z	No requirements
A	20
0	0
2	-20
3	-30
4	-40
5	-50
6	-60

Symbol	Coating type
A	Acid
B	Basic
C	Cellulosic
R	Rutile
RR	Rutile (thick coated)
RC	Rutile-Cellulosic
RA	Rutile-Acid
RB	Rutile-Basic

Symbol	%	Metal recovery %	Type of current
1	<105	<105	AC +DC
2	<105	<105	DC
3	105 <125	105 <125	AC +DC
4	105 <125	105 <125	DC
5	125 <160	125 <160	AC +DC
6	125 <160	125 <160	DC
7	>160	>160	AC +DC
8	>160	>160	DC

Symbol	Chemical composition of all-weld metal, % *		
	Mn	Mo	Ni
No symbol	2.0	-	-
Mo	1,40	0.3 - 0.6	-
MnMo	1.4 - 2.0	0.3 - 0.6	-
1Ni	1,40	-	0.6 - 1.2
2Ni	1,40	-	1.8 - 2.6
3Ni	1,40	-	2.6 - 3.8
Mn1Ni	1.4 - 2.0	-	0.6 - 1.2
1NiMo	1,40	0.3 - 0.6	0.6 - 1.2
Z	Any other agreed composition		



## GUIDE TO EN ISO 2560-B: COVERED ELECTRODES FOR MANUAL METAL ARC WELDING OF NON-ALLOY AND FINE GRAIN STEELS

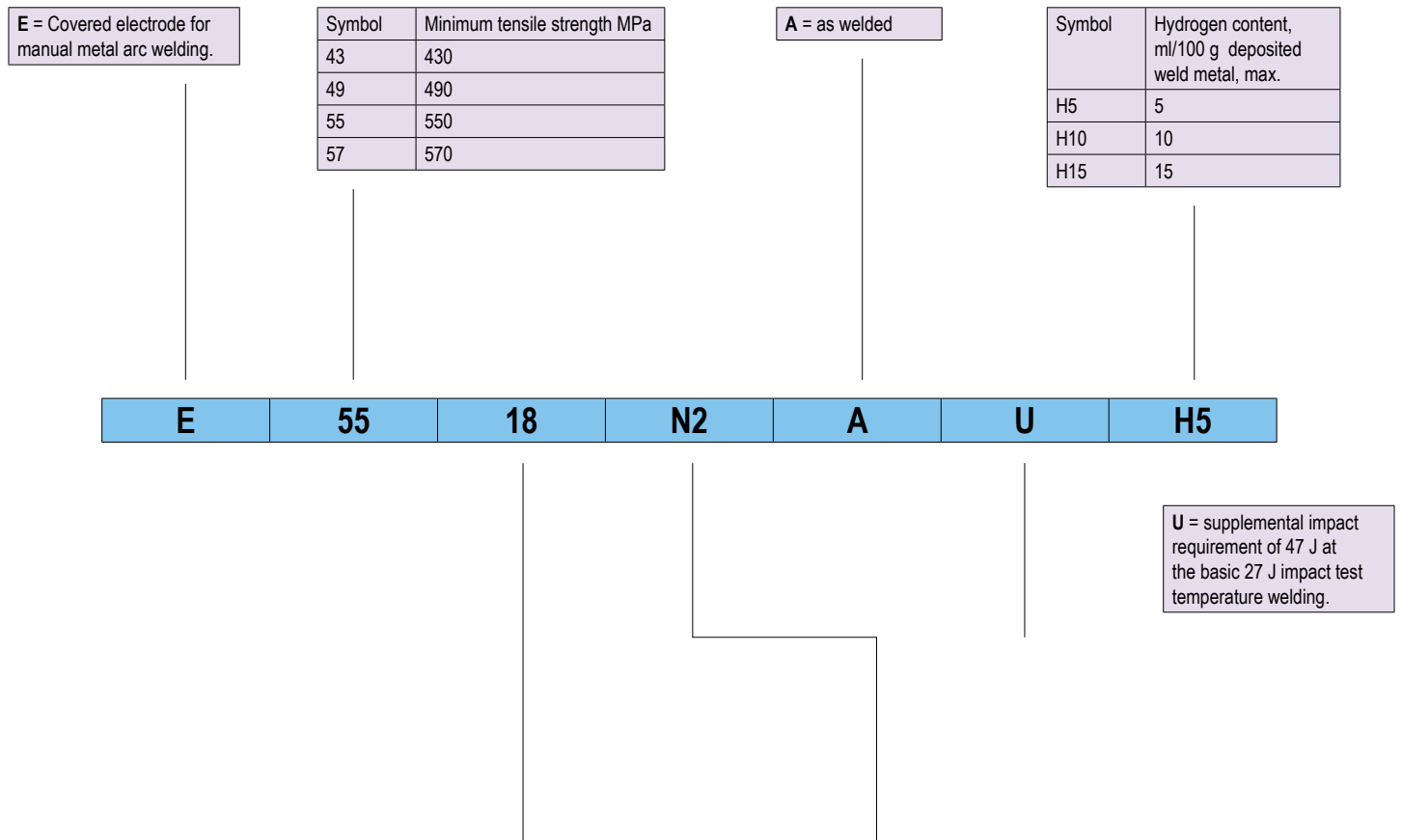

Symbol	Type of covering	Welding positions a)	Type of current
03	rutile basic	all b)	AC or DC(±)
10	cellulosic	all b)	DC(+)
11	cellulosic	all b)	AC or DC(+)
12	rutile	all b)	AC or DC(-)
13	rutile	all b)	AC or DC(±)
14	rutile + iron powder	all b)	AC or DC(±)
15	basic	all b)	DC (+)
16	basic	all b)	AC or DC(+)
18	basic + iron powder	all b)	AC or DC(+)
19	Ilmenit	all b)	AC or DC(±)
20	iron oxide	PA, PB	AC or DC(-)
24	rutile + iron powder	PA, PB	AC or DC(±)
27	iron oxide + iron powder	PA, PB	AC or DC(-)
28	basic + iron powder	PA,PB,PC	AC or DC(+)
40	not specified	Manufacturer's recommendations	Manufacturer's recommendations
48	basic	all b)	AC or DC(+)

NOTE: A description of the characteristic of each of the types of covering is given in annex C

a) Positions are defined in ISO 6947. PA = flat, PB =horizontal vertical fillet, PC = horizontal, PG = vertical down

b) All positions may or may not include vertical down welding. This shall be specified in the manufacturer's trade literature.

AC = ALTERNATING CURRENT  
DC = DIRECT CURRENT

Alloy symbol	Principal alloy element(s)	Nominal level %
No symbol, - ali -P1	1 Mn	1
-1M3	Mo	0,5
-3M2	Mn Mo	1,5 0,4
-3M3	Mn Mo	1,5 0,5
-N1	Ni	0,5
-N2	Ni	1
-N3	Ni	1,5
-3N3	Mn Ni	1,5 1,5
-N5	Ni	2,5
-N7	Ni	3,5
-N13	Ni	6,5
-N2M3	Ni Mo	1 0,5
-NC	Ni Cu	0,5 0,4
-CC	Cr Cu	0,5 0,4
-NCC	Ni Cr Cu	0,2 0,6 0,5
-NCC1	Ni Cr Cu	0,6 0,6 0,5
-NCC2	Ni Cr Cu	0,3 0,2 0,5
-G	1Any other agreed composition	

GUIDE TO EN ISO 3580-A: COVERED ELECTRODES FOR MANUAL METAL ARC WELDING OF CREEP-RESISTING STEELS

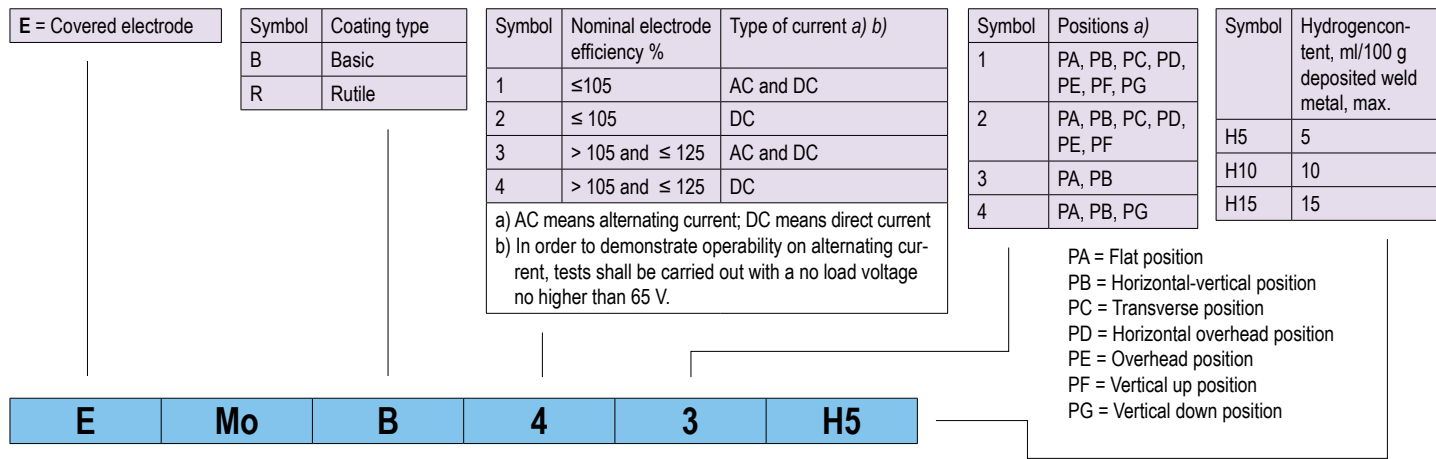

Chemical composition symbols for classification according to		Chemical composition, % b), c)								
Chemical composition ISO 3580-A d	Tensile strength and chemical composition ISO 3580-Be	C	Si	Mn	P	S	Cr	Mo	V	Other elements
Mo	(1M3)	0,10	0,80	0,40 - 1,50	0,030	0,025	0,2	0,40 - 0,70	0,03	—
(Mo)	1M3	0,12	0,80	1,00	0,030	0,030	—	0,40 - 0,65	—	—
MoV		0,03 - 0,12	0,80	0,40 - 1,50	0,030	0,025	0,30 - 0,60	0,80 - 1,20	0,25 - 0,60	—
CrMo0,5	(CM)	0,05 - 0,12	0,80	0,40 - 1,50	0,030	0,025	0,40 - 0,65	0,40 - 0,65	—	—
(CrMo0,5)	CM	0,05 - 0,12	0,80	0,90	0,030	0,030	0,40 - 0,65	0,40 - 0,65	—	—
	C1M	0,07 - 0,15	0,30 - 0,60	0,40 - 0,70	0,030	0,030	0,40 - 0,60	1,00 - 1,25	0,05	—
CrMo1	(1CM)	0,05 - 0,12	0,80	0,40 - 1,50	0,030	0,025	0,90 - 1,40	0,45 - 0,70	—	—
(CrMo1)	1CM	0,05 - 0,12	0,80	0,90	0,030	0,030	1,00 - 1,50	0,40 - 0,65	—	—
CrMo1L	(1CML)	0,05	0,80	0,40 - 1,50	0,030	0,025	0,90 - 1,40	0,45 - 0,70	—	—
(CrMo1L)	1CML	0,05	1,00	0,90	0,030	0,030	1,00 - 1,50	0,40 - 0,65	—	—
CrMoV1		0,05 - 0,15	0,80	0,70 - 1,50	0,030	0,025	0,90 - 1,30	0,90 - 1,30	0,10 - 0,35	—
CrMo2	(2C1M)	0,05 - 0,12	0,80	0,40 - 1,30	0,030	0,025	2,0 - 2,6	0,90 - 1,30	—	—
(CrMo2)	2C1M	0,05 - 0,12	1,00	0,90	0,030	0,030	2,00 - 2,50	0,90 - 1,20	—	—
CrMo2L	(2C1ML)	0,05	0,80	0,40 - 1,30	0,030	0,025	2,0 - 2,6	0,90 - 1,30	—	—
(CrMo2L)	2C1ML	0,05	1,00	0,90	0,030	0,030	2,00 - 2,50	0,90 - 1,20	—	—
	2CML	0,05	1,00	0,90	0,030	0,030	1,75 - 2,25	0,40 - 0,65	—	—
	2C1MV	0,05 - 0,15	0,60	0,40 - 1,50	0,030	0,030	2,00 - 2,60	0,90 - 1,20	0,20 - 0,40	Nb 0,010 - 0,050
	3C1MV	0,05 - 0,15	0,60	0,40 - 1,50	0,030	0,030	2,60 - 3,40	0,90 - 1,20	0,20 - 0,40	Nb 0,010 - 0,050
CrMo5	(5CM)	0,03 - 0,12	0,80	0,40 - 1,50	0,025	0,025	4,0 - 6,0	0,40 - 0,70	—	—
(CrMo5)	5CM	0,05 - 0,10	0,90	1,00	0,030	0,030	4,0 - 6,0	0,45 - 0,65	—	Ni 0,40e
	5CML	0,05	0,90	1,00	0,030	0,030	4,0 - 6,0	0,45 - 0,65	—	Ni 0,40e
CrMo9	(9C1M)	0,03 - 0,12	0,60	0,40 - 1,30	0,025	0,025	8,0 - 10,0	0,90 - 1,20	0,15	Ni 1,0
(CrMo9)	9C1M	0,05 - 0,10	0,90	1,00	0,030	0,030	8,0 - 10,5	0,85 - 1,20	—	Ni 0,40e
	9C1ML	0,05	0,90	1,00	0,030	0,030	8,0 - 10,5	0,85 - 1,20	—	Ni 0,40e
CrMo91	(9C1MV)	0,06 - 0,12	0,60	0,40 - 1,50	0,025	0,025	8,0 - 10,5	0,80 - 1,20	0,15 - 0,30	Ni 0,40 - 1,00 Nb 0,03 - 0,10 N 0,02 - 0,07
(CrMo91)	9C1MV	0,08 - 0,13	0,30	1,25	0,01	0,01	8,0 - 10,5	0,85 - 1,20	0,15 - 0,30	Ni 1,0 Cu 0,25 Al 0,04 Nb 0,02 - 0,10 N 0,02 - 0,07
(CrMo91)	9C1MV1	0,03 - 0,12	0,60	1,00 - 1,80	0,025	0,025	8,0 - 10,5	0,80 - 1,20	0,15 - 0,30	Ni 1,0 Cu 0,25 Al 0,04 Nb 0,02 - 0,10 N 0,02 - 0,07
CrMoWV12		0,15 - 0,22	0,80	0,40 - 1,30	0,025	0,025	10,0 - 12,0	0,80 - 1,20	0,20 - 0,40	Ni 0,8 W 0,40 - 0,60
Z	G	Any other agreed composition								

a) A designation in parentheses [e.g., (CrMo1) or (1CM)] indicates a near match in the other designation system, but not an exact match. The correct designation for a given composition range is the one without parentheses. A given product may, by having a more restricted chemical composition which fulfils both sets of designation requirements, be assigned both designations independently, provided that the mechanical property requirements of Table 2 are also satisfied.

b) Single values shown in the table are maximum values

c) If not specified: Ni < 0,3 %, Cu < 0,3 %, Nb < 0,01 %

d) Elements listed without specified values shall be reported, if intentionally added. The total of these unspecified elements and all other elements found in the course of routine chemical analysis shall not exceed 0,50 %

## GUIDE TO EN ISO 3580-B: COVERED ELECTRODES FOR MANUAL METAL ARC WELDING OF CREEP-RESISTING STEELS

Symbol	Type of covering	Welding positions a)	Type of current b)
10c	cellulosic	all	DC(+)
11c	cellulosic	all	AC DC(+)
13c	rutile	alld	AC und DC(±)
15	basic	alld	DC (+)
16	basic	alld	AC und DC(+)
18	basic + metal powder	all except PG	AC und DC(+)
19c	Ilmenit	alld	AC und DC(±)
20c	iron oxide	PA, PB	AC und DC(-)
27c	iron oxide + iron powder	PA, PB	AC und DC(-)

Chemical composition see 3580 A.

Symbol	Hydrogen content, ml/100 g deposited weld metal, max.
H5	5
H10	10
H15	15

- a) Positions are defined in ISO 6947. PA = flat, PB = horizontal vertical fillet, PC = horizontal, PG = vertical down  
b) AC means alternating current; DC means direct current  
c) Composition designator 1M3 only.  
d) All positions may or may not include vertical down welding. This shall be specified in the manufacturer's trade literature.

E = Covered electrode

**E****55****18****1CM****H5**

Chemical composition symbols for classification according to		Minimum c) yield strength MPa	Minimum tensile strength MPa	Minimum d) elongation %	Impact energy J at + 20 °C		Heat treatment of all-weld metal		
Chemical composition ISO 3580-A d)	Tensile strength and chemical composition ISO 3580-Bb e)				Minimum average from three test specimens	Minimum single value	Preheat and interpass temperature °C	Postweld heat treatment of test assembly	
						Temperature f °C		Time min	
Mo	(1M3)	355	510	22	47	38	< 200	570 - 620	60g
(Mo)	49XX-1M3	390	490	22	—	—	90 - 110	605 - 645	60h
(Mo)	49YY-1M3	390	490	20	—	—	90 - 110	605 - 645	60h
MoV		355	510	18	47	38	200 - 300	690 - 730	60g
CrMo0,5	(55XX-CM)	355	510	22	47	38	100 - 200	600 - 650	60g
(CrMo0,5)	55XX-CM	460	550	17	—	—	160 - 190	675 - 705	60h
	55XX-C1M	460	550	17	—	—	160 - 190	675 - 705	60h
CrMo1	(55XX-1CM) (5513-1CM)	355	510	20	47	38	150 - 250	660 - 700	60g
(CrMo1)	55XX-1CM	460	550	17	—	—	160 - 190	675 - 705	60h
(CrMo1)	5513-1CM	460	550	14	—	—	160 - 190	675 - 705	60h
CrMo1L	(52XX-1CML)	355	510	20	47	38	150 - 250	660 - 700	60g
(CrMo1L)	52XX-1CML	390	520	17	—	—	160 - 190	675 - 705	60h
CrMoV1		435	590	15	24	19	200 - 300	680 - 730	60g
CrMo2	(62XX-2C1M) (6213-2C1M)	400	500	18	47	38	200 - 300	690 - 750	60g
(CrMo2)	62XX-2C1M	530	620	15	—	—	160 - 190	675 - 705	60h
(CrMo2)	6213-2C1M	530	620	12	—	—	160 - 190	675 - 705	60h
CrMo2L	(55XX-2C1ML)	400	500	18	47	38	200 - 300	690 - 750	60g
(CrMo2L)	55XX-2C1ML	460	550	15	—	—	160 - 190	675 - 705	60h
	55XX-2CML	460	550	15	—	—	160 - 190	675 - 705	60h
	62XX-2C1MV	530	620	15	—	—	160 - 190	725 - 755	60g
	62XX-3C1MV	530	620	15	—	—	160 - 190	725 - 755	60h
CrMo5	(55XX-5CM)	400	590	17	47	38	200 - 300	730 - 760	60g
(CrMo5)	55XX-5CM	460	550	17	—	—	175 - 230	725 - 755	60h
	55XX-5CML	460	550	17	—	—	175 - 230	725 - 755	60h
CrMo9	(62XX-9C1M)	435	590	18	34	27	200 - 300	740 - 780	120g
(CrMo9)	62XX-9C1M	530	620	15	—	—	205 - 260	725 - 755	60h
	62XX-9C1ML	530	620	15	—	—	205 - 260	725 - 755	60h
CrMo91	(62XX-9C1MV)	415	585	17	47	38	200 - 300	750 - 770	120 - 180
(CrMo91)	62XX-9C1MV	530	620	15	—	—	230 - 290	725 - 755	60h
(CrMo91)	62XX-9C1MV1	530	620	15	—	—	205 - 260	725 - 755	60h
CrMoWV12		550	690	15	34	27	250 - 350i or 400 - 500i	740 - 780	120g
Z	G	As agreed between purchaser and supplier							

- a) A designation in parentheses [e.g., (CrMo1) or (1CM)] indicates a near match in the other designation system, but not an exact match. The correct designation for a given composition range is the one without parentheses. A given product may, by having a more restricted chemical composition that fulfils both sets of mechanical property requirements, be classified in both systems independently, provided that the chemical composition requirements of Table 1 are also satisfied.  
b) XX stands for coating types 15, 16 or 18. YY stands for coating types 10, 11, 19, 20 or 27. See Table 3B.  
c) For yield strength, the lower yield, ReL, shall be used when yielding occurs; otherwise the 0,2 % proof strength, Rp0,2, shall be used.  
d) Gauge length is equal to five times the test specimen diameter.  
e) Only one single value lower than the minimum average is permitted.  
f) The test assembly shall be cooled in the furnace to 300 °C at a rate not exceeding 200 °C/h.  
g) Tolerance shall be plus or minus 10 min.  
h) Tolerance shall be zero, plus 10 min. The heating rate in the furnace shall be 85 °C to 275 °C/h.  
i) Immediately after welding the specimen is to be allowed to cool down to 120 °C to 100 °C and kept at this temperature for at least 1 h.

WELDING KNOW-HOW - STANDARD

GUIDE TO EN ISO 3581: COVERED ELECTRODES FOR MANUAL METAL ARC WELDING OF STAINLESS AND HEAT-RESISTING STEELS (former EN 1600)

E = Covered electrode

Symbol	Coating type
R	Rutile
B	Bacic

Symbol	%	Metal recovery %	Type of current
1	<105	<105	AC +DC
2	<105	<105	DC
3	105 <125	105 <125	AC +DC
4	105 <125	105 <125	DC
5	125 <160	125 <160	AC +DC
6	125 <160	125 <160	DC
7	>160	>160	AC +DC
8	>160	>160	DC

<b>E</b>	<b>19 12 3 L</b>	<b>R</b>	<b>3</b>	<b>4</b>
----------	------------------	----------	----------	----------

PA = Flat position  
 PB = Horizontal-vertical position  
 PC = Transverse position  
 PD = Horizontal overhead position  
 PE = Overhead position  
 PF = Vertical up position  
 PG = Vertical down position

Symbol	Welding Position
1	PA, PB, PC, PD, PE, PF & PG
2	PA, PB, PC, PD, PE & PF
3	PA & PB,
4	PA
5	PA, PB & PG

AC = ALTERNATING CURRENT  
 DC = DIRECT CURRENT

Alloy Symbol		Chemical composition of all-weld metal, % *								
ISO	AWS A 5.4	C	Si	Mn	P	S	Cr	Ni	Mo	Other elements
<b>Martensitic / ferritic</b>										
13	E410	0.12	1.0	150	0.030	0.025	11.0-14.0	0.60	0.75	Cu 0.75
13 4	E410NiMo	0.06	1.0	1,50	0.030	0.025	11.0-14.5	3.0-5.0	0.4-1.0	Cu 0.75
17	E430	0.12	1.0	1,5	0.030	0.025	16.0-18.0	0.60	0.75	Cu 0.75
<b>Austenitic</b>										
19 9	E308	0.08	1,20	2.0	0.030	0.025	18.0-21.0	9.0-11.0	0.75	Cu 0.75
19 9 L	E308 L	0.04	1,20	2.0	0.030	0.025	18.0-21.0	9.0-11.0	0.75	Cu 0.75
19 9 Nb	E347	0.08	1,20	2.0	0.030	0.025	18.0-21.0	9.0-11.0	0.75	Cu 0.75, Ta+Nb 8 x C < 1.1
19 12 2	E316	0.08	1,20	2.0	0.030	0.025	17.0-20.0	10.0-13.0	2.0-3.0	Cu 0.75
19 12 3 L		0.04	1,20	2.0	0.030	0.025	17.0-20.0	10.0-13.0	2.5-3.0	Cu 0.75
19 12 3 Nb	E318	0.08	1,20	2.0	0.030	0.025	17.0-20.0	10.0-13.0	2.5-3.0	Cu 0.75, Ta+Nb 8 x C < 1.1
19 13 4N L		0.04	1,20	1.0-5.0	0.030	0.025	17.0-20.0	12.0-15.0	3.0-4.5	Cu 0.75, N 0.20
<b>Austenitic-ferritic. High corrosion resistance.</b>										
22 9 3 N L	E2293	0.04	1,20	2,50	0.030	0.025	21.0-24.0	7.5-10.5	2.5-4.0	Cu 0.75, N 0.08-0.20
25 7 2 N L		0.04	1,20	2.0	0.035	0.025	24.0-28.0	6.0-8.0	1.0-3.0	Cu 0.75, N 0.20
25 9 3 Cu N L	E2593	0.04	1,20	2,50	0.030	0.025	24.0-27.0	7.5-10.5	2.5-4.0	N 0.10-0.25, Cu 1.5-3.5
25 9 4 Cu N L	E2594	0.04	1,20	2,50	0.030	0.025	24.0-27.0	8.0-11.0	2.5-4.5	N 0.20-0.30, Cu 1.5, W 1.0
<b>Fully austenitic. High corrosion resistance.</b>										
18 15 3 L		0.04	1,20	1.0-4.0	0.030	0.025	16.5-19.5	14.0-17.0	2.5-3.5	Cu 0.75
18 16 5 N L		0.04	1,20	1.0-4.0	0.035	0.025	17.0-20.0	15.5-19.0	3.5-5.0	Cu 0.75, N 0.20
20 25 5 Cu N L		0.04	1,20	1.0-4.0	0.030	0.025	19.0-22.0	24.0-27.0	4.0-7.0	Cu 1.0-2.0, N 0.25
20 16 3 Mn N L	E316Mn	0.04	1,20	5.0-8.0	0.035	0.025	18.0-21.0	15.0-18.0	2.5-3.5	Cu 0.75, N 0.20
25 22 2 N L		0.04	1,20	1.0-5.0	0.030	0.025	24.0-27.0	20.0-23.0	2.0-3.0	Cu 0.75, N 0.20
27 31 4 Cu L		0.04	1,20	2,50	0.030	0.025	26.0-29.0	30.0-33.0	3.0-4.5	Cu 0.6-1.5
<b>Special types</b>										
18 8 Mn		0.20	1,20	4.5-7.5	0.035	0.025	17.0-20.0	7.0-10.0	0.75	Cu 0.75
18 9 Mn Mo	E307	0.04-0.14	1,20	3.0-5.0	0.035	0.025	18.0-21.5	9.0-11.0	0.5-1.5	Cu 0.75
20 10 3	E308Mo	0.10	1,20	2,50	0.030	0.025	18.0-21.0	9.0-12.0	1.5-3.5	Cu 0.75
23 12 L	E309LMo	0.04	1,20	2,50	0.030	0.025	22.0-25.0	11.0-14.0	0.75	Cu 0.75
23 12 Nb	E309Nb	0.10	1,20	2,50	0.030	0.025	22.0-25.0	11.0-14.0	0.75	Cu 0.75, Ta+Nb 8 x C < 1.1
23 12 2 L		0.04	1,20	2,50	0.030	0.025	22.0-25.0	11.0-14.0	2.0-3.0	Cu 0.75
29 9	E312	0.15	1,20	2,50	0.035	0.025	27.0-31.0	8.0-12.0	0.75	Cu 0.75
<b>Heat resisting types</b>										
16 8 2	E16-8-2	0.08	0.6	2,50	0.030	0.025	14.5-16.5	7.5-9.5	1.5-2.5	Cu 0.75
19 9 H	E308 H	0.04-0.08	1,20	2.0	0.03	0.025	18.0-21.0	9.0-11.0	0.75	Cu 0.75
25 4		0.15	1,20	2,50	0.030	0.025	24.0-27.0	4.0-6.0	0.75	Cu 0.75
22 12	E309	0.15	1,20	2,50	0.030	0.025	20.0-23.0	10.0-13.0	0.75	Cu 0.75
22 12 L	E309 L	0.04	1,20	2,50	0.030	0.025	20.0-23.0	10.0-13.0	0.75	Cu 0.75
25 20	E310	0.06-0.20	1,20	1.0-5.0	0.030	0.025	23.0-27.0	18.0-22.0	0.75	Cu 0.75
25 20 H	E310H	0.35-0.45	1,20	2,50	0.030	0.025	23.0-27.0	18.0-22.0	0.75	Cu 0.75
18 36	E330	0.25	1,20	2,50	0.030	0.025	14.0-18.0	33.0-37.0	0.75	Cu 0.75

\* Single values shown in the table are maximum values.

## GUIDE TO EN ISO 6848: ARC WELDING AND CUTTING - NONCONSUMABLE TUNGSTEN ELECTRODES - CLASSIFICATION

W = Tungsten electrodes

W

Ce-2

Symbol	Chemical composition of all-weld metal , % *				Color code, RGB colour value and colour sample a)	Description and Intended Use of Electrodes
	Oxide Addition		Impurities	Tungsten		
	Principal Oxide	Mass Percent	Mass Percent	Mass Percent		
WP	Keine	N.A.b	0.5 max.	99.5 max	Green #008000	<b>The standard electrode for aluminium welding</b> Composition: W pure A classic with medium welding properties. To improve durability, ignition and load capacity there are replacement options <b>Categories:</b> Radiation free, AC welding
WCe 20	CeO <sub>2</sub>	1.8 - 2.2	0.5 max.	rest	Grey (formerly orange) #808080	<b>The classic for direct current welding</b> Composition: W + 2% cerium Next to WL15 and WT20 the most popular tungsten electrode. Their advantage is an excellent tool life. Minor reductions in the ignition capability have to be accepted <b>Categories:</b> Radiation free, Direct current welding
WLa 10	La <sub>2</sub> O <sub>3</sub>	0.8 - 1.2	0.5 max.	rest	Black #000000	<b>The favourite for plasma welding and cutting</b> Composition: W + 1% lanthanum With 1% lanthanum, which has a decisive influence on the ignition capability. Main application area is plasma cutting and welding <b>Categories:</b> Radiation free, Direct current welding
WLa 15	La <sub>2</sub> O <sub>3</sub>	1.3 - 1.7	0.5 max.	rest	Gold #FFD700	<b>A talent in all areas</b> Composition: W + 1.5% lanthanum A real alternative to the WT20! Due to the higher lanthanum content the ignition behaviour is further improved compared to the WL10 <b>Categories:</b> Radiation free, Universal, DC welding, AC welding, Stainless steel
WLa 20	La <sub>2</sub> O <sub>3</sub>	1.8 - 2.2	0.5 max.	rest	Blue #0000FF	<b>Unsurpassed use in automated welding</b> Composition: W + 2% lanthanum The electrode with the currently highest lanthanum content ensures unsurpassed ignition results. The main field of application is automated welding <b>Categories:</b> radiation free, automatic welding machine, direct current welding
WTh 10	ThO <sub>2</sub>	0.8 - 1.2	0.5 max.	rest	Yellow #FFFF00	No longer plays a major role
WTh 20	ThO <sub>2</sub>	1.7 - 2.2	0.5 max.	rest	Red #FF0000	<b>The igniter - 2% thorium</b> Composition: W + 2% thorium Due to its very good ignition properties, this is a widely used type of electrode, which however, due to its 2% share of radioactive thorium, is increasingly being discussed. This type can now be successfully replaced by radiation-free electrodes such as WL15 <b>Categories:</b> Thorium-containing, direct current welding
(WTh 30)	ThO <sub>2</sub>	2.8 - 3.2	0.5 max.	rest	Violet #EE82EE	<b>3% Thorium - for better ignition behaviour</b> Composition: W + 3% thorium Less common electrode type with very good ignition properties devices like the WT20 are increasingly being discussed and can now be successfully replaced completely by radiation-free electrodes such as Lymox or WL15 <b>Categories:</b> Thorium-containing, direct current welding
WZr 3	ZrO <sub>2</sub>	0.15 - 0.50	0.5 max.	rest	Brown #A52A2A	No longer plays a major role
WZr 8	ZrO <sub>2</sub>	0.7 - 0.9	0.5 max.	rest	White #FFFFFF	<b>The specialist for aluminium</b> Composition: W + 0.8% zirconium Improved ignition, lifetime & current carrying capacity compared to the green electrode <b>Categories:</b> Radiation free, AC welding

**GENERAL NOTE:**

Intentional additions of "doping oxides" other than indicated for a particular electrode classification is prohibited.

**NOTES:**a) RGB color values and color samples can be found at the following website: <http://msdn2.microsoft.com/en-us/library/ms531197.aspx>

b) N.A.= Not applicable

GUIDE TO EN ISO 12153: TUBULAR CORED ELECTRODES FOR GAS SHIELDED AND NON-GAS SHIELDED METAL ARC WELDING OF NICKEL AND NICKEL ALLOYS

The symbol for the chemical composition of the all-weld metal shall comprise "Ni" plus for digits as shown in Tab 1 Norm

The first digit is an indicator of the class of alloy deposited:

- **2** No significant alloy addition
- **4** Significant copper addition
- **6** Significant chromium addition, with iron less than 25% (NiCrFe and NiCrMo alloys)
- **8** Significant chromium addition, with iron more than 25% (NiFeCr alloys)
- **10** Significant molybdenum addition without significant chromium addition (NiMo alloys)

The remaining digits indicate the particular alloy deposited. Look Annex of the Norm

Optional chemical symbol of covered electrode (see Tab1 Norm)

Symbol	Positions
1	PA, PB, PC, PD, PE, PF & PG
2	PA, PB, PC, PD, PE, PF
3	PA & PB,
4	PA
5	PA, PB & PG

Symbol	Properties
P	Rutile, slowly solidifying slag
R	Rutile, quickly solidifying slag
B	Basic
M	Metal-cored
U	self-protecting
Z	Other types

PA = Flat position  
 PB = Horizontal-vertical position  
 PC = Transverse position  
 PD = Horizontal overhead position  
 PE = Overhead position  
 PF = Vertical up position  
 PG = Vertical down position

Shielding gas according to ISO 14175

T = Tubular cored electrode

**T Ni 61 82 ( NiCr15Fe6Mn ) B M21 2**

Alloy code		Chemical composition % (m/m)														
numerically	chemically	C	Mn	Fe	Si	Cu	Ni	Co	Al	Ti	Cr	Nb	Mo	V	W	Sonstige
<b>Nickel-Copper</b>																
Ni 4060	NiCu30Mn3Ti	0,15	4.0	2.5	1.5	27,0 - 34,0	≥62.0	-	-	1.0	-	-	-	-	-	-
Ni 4061	NiCu27Mn3NbTi	0,15	4.0	2.5	1.3	24,0 - 31,0	≥62.0	-	-	1.5	-	3.0	-	-	-	-
<b>Nickel-Chrome</b>																
Ni 4082	NiCr20Mn3Nb	0,10	2,5 - 3,5	3.0	0.50	0.50	≥67.0	-	-	0.75	18.0 - 22.0	2.0 - 3.0	2.0	-	-	P 0.03
Ni 4083	NiCr20Mn6Fe4Nb	0,10	4.0 - 8.0	4.0	0.8	0.50	≥60.0	-	-	0.5	18.0 - 22.0	1.5 - 3.0	2.0	-	-	-
<b>Nickel-Molybdenum</b>																
Ni 1013	NiMo17Cr7W	0,10	2.0 - 3.0	10.0	0.75	0.50	≥58.0	-	-	-	4.0 - 8.0	-	16.0 - 19.0	-	2.0 - 4.0	-
<b>Nickel-Chrome-Iron</b>																
Ni 6062	NiCr15Fe8Nb	0,08	3,5	11.0	0.75	0.50	≥62.0	-	-	-	13.0 - 17.0	2.0 - 4.0	-	-	-	P 0.03
Ni 6133	NiCr16Fe12NbMo	0,10	1.0 - 3.5	12.0	0.75	0.50	≥62.0	-	-	-	13.0 - 17.0	0.5 - 3.0	0.5 - 2.5	-	-	P 0.03 S 0.02
Ni 6182	NiCr15Fe6Mn	0,10	5.0 - 9.5	10.0	1.0	0.50	≥59.0	-	-	1.0	13.0 - 17.0	1.0 - 2.5	-	-	-	P 0.03
Ni 6152	NiCr30Fe9Nb	0,05	5.0	7.0 - 12.0	0.8	0.50	≥50.0	-	0.5	0.5	28.0 - 31.5	1.0 - 2.5	0.5	-	-	-
<b>Nickel-Chrome- Molybdenum</b>																
Ni 6002	NiCr22Fe18Mo	0,05 - 0,15	1.0	17.0 - 20.0	1.0	0.50	≥45.0	0,5 - 2,5	-	-	20.5 - 23.0	-	8.0 - 10.0	-	0.2 - 1.0	P 0.04 S 0.03
Ni 6012	NiCr22Mo9	0,03	1.0	3.5	0,7	0.50	≥58.0	-	0.4	0.4	20.0 - 23.0	1.5	8.5 - 10.5	-	-	-
Ni 6022	NiCr21Mo13W3	0,02	1.0	2.0 - 6.0	0.2	0.50	≥49.0	2,5	-	-	20.0 - 22.5	-	12.5 - 14.5	0.35	2.5 - 3.5	P / S 0.03
Ni 6059	NiCr23Mo16	0,02	1.0	1.5	0.2	0.50	≥56.0	-	-	-	22.0 - 24.0	-	15.0 - 16,5	-	-	-
Ni 6275	NiCr15Mo16Fe5W3	0,10	1.0	4.0 - 7.0	1.0	0.50	≥50.0	2,5	-	-	14.5 - 16.5	-	15.0 - 18,0	0.4	-	-
Ni 6276	NiCr15Mo15Fe6W4	0,02	1.0	4.0 - 7.0	0.2	0.50	≥50.0	2,5	-	-	14.5 - 16.5	-	15.0 - 17,0	0.35	3.0 - 4,5	P / S 0.03
Ni 6455	NiCr16Mo15Ti	0,02	1.5	3.0	0.2	0.50	≥56.0	2,0	-	0.7	14.0 - 18.0	-	14.0 - 17,0	-	0.5.	-
Ni 6456	NiCr16Mo10Nb	0,10	5.0 - 8.0	10.0	0.8	0.50	≥58.0	-	-	1.0	15.0 - 18.0	1.5 - 3.0	9.0 - 11,0	-	-	-
Ni 6625	NiCr22Mo9Nb	0,10	0.50	5.0	0.80	0.50	≥58.0	-	-	0.40	20.0 - 23.0	3.15 - 4.15	8.0 - 10,0	-	-	-
Ni 6686	NiCr21Mo16W4	0,02	1.0	5.0	0.3	0.50	≥49.0	-	-	0.30	19.0 - 23.0	-	15.0 - 17,0	-	3.0 - 4.4	-
<b>Nickel-Chrome-Cobalt-Molybdenum</b>																
Ni 6117	NiCr22Co12Mo	0,05 - 0,15	2.5	0.50	0.75	0.50	≥45.0	9,0 - 15,0	-	-	21.0 - 26.0	1.0	8.0 - 10.0	-	-	P 0.03
Ni 6617	NiCr22Co12MoAlTi	0,05 - 0,15	2.5	0.50	0.75	0.50	≥45.0	9,0 - 15,0	1.5	0.6	21.0 - 26.0	1.0	8.0 - 10.0	-	-	-
Z	Any other agreed composition															

7



## GUIDE TO EN ISO 12153: TUBULAR CORED ELECTRODES FOR GAS SHIELDED AND NON-GAS SHIELDED METAL ARC WELDING OF NICKEL AND NICKEL ALLOYS

Alloy code		Minimum yield strength Rp0,2	Minimum tensile strength Rm	Minimum d elongation 5d
numerically	chemically	MPa	MPa	%
<b>Nickel-Copper</b>				
Ni 4060	NiCu30Mn3Ti	200	480	27
Ni 4061	NiCu27Mn3NbTi	200	480	27
<b>Nickel-Chrome</b>				
Ni 6082	NiCr20Mn3Nb	360	550	22
Ni 6083	NiCr20Mn6Fe4Nb	360	600	27
<b>Nickel-Molybdenum</b>				
Ni 1013	NiMo17Cr7W	400	690	27
<b>Nickel-Chrome-Iron</b>				
Ni 6062	NiCr15Fe8Nb	360	550	22
Ni 6133	NiCr16Fe12NbMo	360	550	22
Ni 6182	NiCr15Fe6Mn	360	550	22
Ni 6152	NiCr30Fe9Nb	360	550	27
<b>Nickel-Chrome-Molybdenum</b>				
Ni 6002	NiCr22Fe18Mo	380	620	22
Ni 6012	NiCr22Mo9	410	650	22
Ni 6022	NiCr21Mo13W3	350	690	22
Ni 6059	NiCr23Mo16	350	690	22
Ni 6275	NiCr15Mo16Fe5W3	400	690	22
Ni 6276	NiCr15Mo15Fe6W4	400	690	22
Ni 6455	NiCr16Mo15Ti	300	690	22
Ni 6456	NiCr16Mo10Nb	400	690	27
Ni 6625	NiCr22Mo9Nb	420	690	22
Ni 6686	NiCr21Mo16W4	350	690	27
<b>Nickel-Chromium-Cobalt-Molybdenum</b>				
Ni 6117	NiCr22Co12Mo	400	620	22
Ni 6617	NiCr22Co12MoAlTi	400	620	22

GUIDE TO EN ISO 14171-A: SOLID WIRE ELECTRODES, TUBULAR CORED ELECTRODES AND ELECTRODE/FLUX COMBINATIONS FOR SUBMERGED ARC WELDING OF NON ALLOY AND FINE GRAIN STEELS

multi-run welding

**S 46 3 AB S2**

Symbol	Minimum yield strength a)	Tensile strength	Minimum elongation b)
	MPa	MPa	%
35	355	440 - 570	22
38	380	470 - 600	20
42	420	500 - 640	20
46	460	530 - 680	20
50	500	560 - 720	18

- a) For yield strength the lower yield strength (ReL) is used when yielding occurs, otherwise the 0,2 % proof strength (Rp0,2) is used.  
 b) Gauge length is equal to five times the test specimen diameter.

Symbol	Impact Energy Charpy-V Temp °C for 47J min.
Z	No requirements
A	20
0	0
2	-20
3	-30
4	-40
5	-50
6	-60
7	-70
8	-80
9	-90
10	-100

Type of flux	Symbol
Manganese-silicate	MS
Calcium-silicate	CS
Calcium-magnesium oxides	CG
Calcium-magnesium basic oxides	CB
Calcium-magnesium oxides with iron	CI
Calcium-magnesium basic oxides with iron	IB
Zirconium-silicate	ZS
Rutile-silicate	RS
Alumina-rutile	AR
Alumina-basic	AB
Alumina-silicate	AS
Alumina-fluoride-basic	AF
Fluoride-basic	FB
Any other composition	Z

multi-run welding

**S 4T 2 AB S2**

Symbol	Minimum parent material yield strength	Minimum tensile strength of the welded joint
	MPa	MPa
2T	275	370
3T	355	470
4T	420	520
5T	500	600

Symbol	Chemical composition (% by mass) a) b) c)								
	C	Si	Mn	P	S	Mo	Ni	Cr	Cu
S1	0,05 - 0,15	0,15	0,35 - 0,60	0,025	0,025	0,15	0,15	0,15	0,30
S2	0,07 - 0,15	0,15	0,80 - 1,30	0,025	0,025	0,15	0,15	0,15	0,30
S3	0,07 - 0,15	0,15	1,30 - 1,75	0,025	0,025	0,15	0,15	0,15	0,30
S1Si	0,07 - 0,15	0,15 - 0,40	0,35 - 0,60	0,025	0,025	0,15	0,15	0,15	0,30
S2Si	0,07 - 0,15	0,15 - 0,40	0,80 - 1,30	0,025	0,025	0,15	0,15	0,15	0,30
S2Si2	0,07 - 0,15	0,40 - 0,60	0,80 - 1,30	0,025	0,025	0,15	0,15	0,15	0,30
S3Si	0,07 - 0,15	0,15 - 0,40	1,30 - 1,85	0,025	0,025	0,15	0,15	0,15	0,30
S4Si	0,07 - 0,15	0,15 - 0,40	1,85 - 2,25	0,025	0,025	0,15	0,15	0,15	0,30
S1Mo	0,05 - 0,15	0,05 - 0,25	0,35 - 0,60	0,025	0,025	0,45 - 0,65	0,15	0,15	0,30
S2Mo	0,07 - 0,15	0,05 - 0,25	0,80 - 1,30	0,025	0,025	0,45 - 0,65	0,15	0,15	0,30
S3Mo	0,07 - 0,15	0,05 - 0,25	1,30 - 1,75	0,025	0,025	0,45 - 0,65	0,15	0,15	0,30
S4Mo	0,07 - 0,15	0,05 - 0,25	1,75 - 2,25	0,025	0,025	0,45 - 0,65	0,15	0,15	0,30
S2Ni1	0,07 - 0,15	0,05 - 0,25	0,80 - 1,30	0,020	0,020	0,15	0,80 - 1,20	0,15	0,30
S2Ni1,5	0,07 - 0,15	0,05 - 0,25	0,80 - 1,30	0,020	0,020	0,15	1,20 - 1,80	0,15	0,30
S2Ni2	0,07 - 0,15	0,05 - 0,25	0,80 - 1,30	0,020	0,020	0,15	1,80 - 2,40	0,15	0,30
S2Ni3	0,07 - 0,15	0,05 - 0,25	0,80 - 1,30	0,020	0,020	0,15	2,80 - 3,70	0,15	0,30
S2Ni1Mo	0,07 - 0,15	0,05 - 0,25	0,80 - 1,30	0,020	0,020	0,45 - 0,65	0,80 - 1,20	0,20	0,30
S3Ni1,5	0,07 - 0,15	0,05 - 0,25	1,30 - 1,70	0,020	0,020	0,15	1,20 - 1,80	0,20	0,30
S3Ni1Mo	0,07 - 0,15	0,05 - 0,25	1,30 - 1,80	0,020	0,020	0,45 - 0,65	0,80 - 1,20	0,20	0,30
S3Ni1Mo0,2	0,07 - 0,15	0,05 - 0,35	1,2 - 1,6	0,015	0,015	0,15 - 0,30	0,80 - 1,20	0,15	0,30
S3Ni1,5Mo	0,07 - 0,15	0,05 - 0,35	1,20 - 1,80	0,020	0,020	0,30 - 0,50	1,20 - 1,80	0,20	0,30
S2Ni1Cu	0,08 - 0,12	0,15 - 0,35	0,70 - 1,20	0,020	0,020	0,15	0,65 - 0,90	0,40	0,40 - 0,65
S3Ni1Cu	0,05 - 0,15	0,15 - 0,40	1,20 - 1,70	0,025	0,025	0,15	0,60 - 1,20	0,15	0,30 - 0,60
SZ <sup>d)</sup>	Any agreed composition								

- a) Finished product chemical composition, Cu inclusive of a copper coating, Al ≤ 0,30 %.  
 b) Single values shown in the table are maximum values.  
 c) The results shall be rounded to the same number of significant figures as in the specified value using the rules in accordance with annex B, Rule of ISO 31-0:1992.  
 d) Consumables for which the chemical composition is not listed in the table shall or may \*) be symbolized similarly and prefixed by the letter Z. The chemical composition ranges are not specified and therefore two electrodes with the same Z classification may not be interchangeable. \*) shall or may has to be decided for each standard.

## GUIDE TO EN ISO 14171-A: SOLID WIRE ELECTRODES, TUBULAR CORED ELECTRODES AND ELECTRODE/FLUX COMBINATIONS FOR SUBMERGED ARC WELDING OF NON ALLOY AND FINE GRAIN STEELS

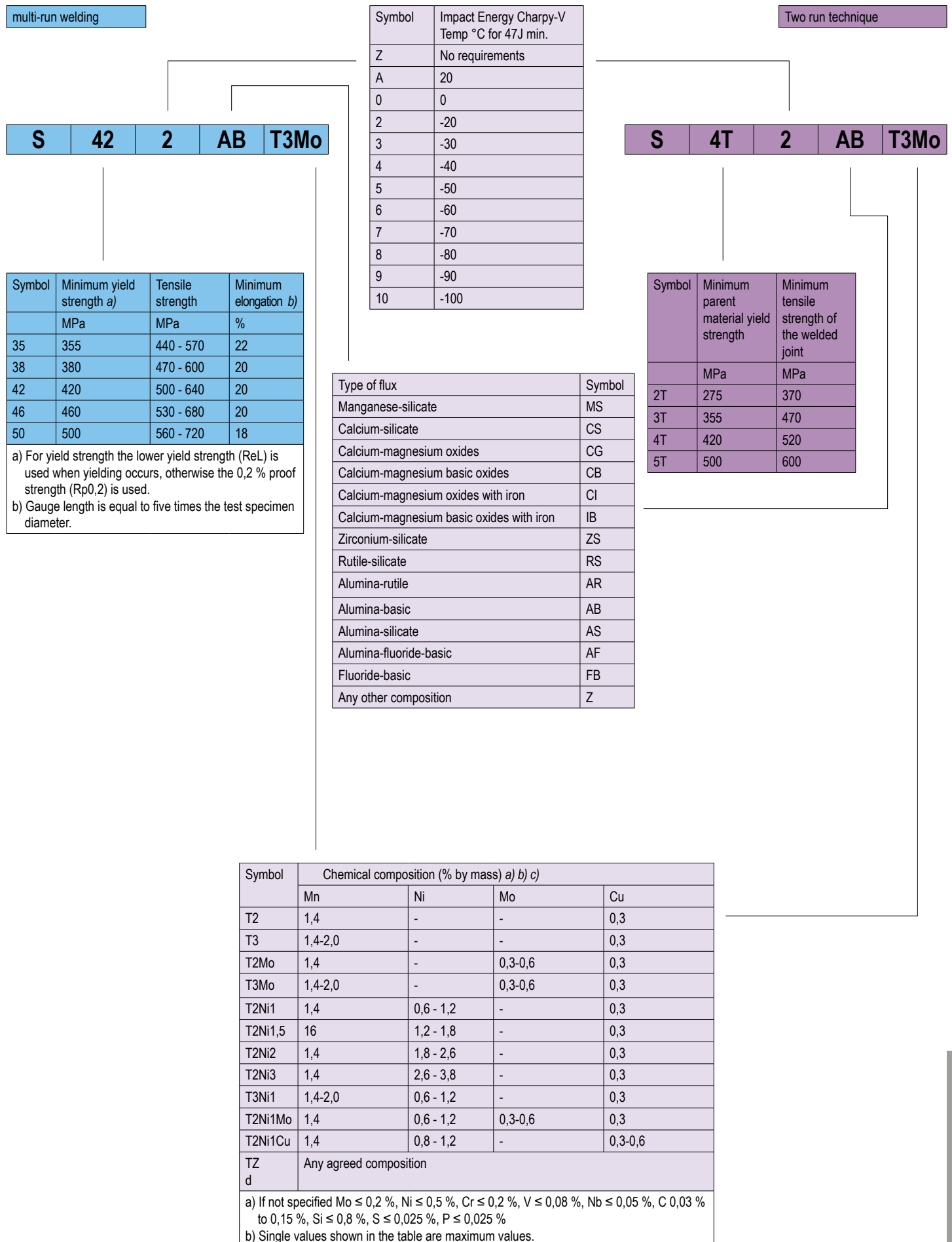

WELDING KNOW-HOW - STANDARD

GUIDE TO EN ISO 14171-B SOLID WIRE ELECTRODES, TUBULAR CORED ELECTRODES AND ELECTRODE/FLUX COMBINATIONS FOR SUBMERGED ARC WELDING OF NON ALLOY AND FINE GRAIN STEELS

multi-run welding

**S 49A 2 AB S2**

Symbol	Minimum yield strength a)	Tensile strength	Minimum elongation b)
	MPa	MPa	%
43X	330	430 - 600	20
49X	390	490 - 670	18
55X	460	550 - 740	17
57X	490	570 - 770	17

- a) X is "A" or "P", where "A" indicates testing in the as-welded condition and "P" indicates testing in the post weld heat-treated condition.
- b) For yield strength, the 0,2 % proof strength (Rp0,2) is used.
- c) Gauge length is equal to five times the test specimen diameter.

Symbol	Impact Energy Charpy-V Temp °C for 27J min.
Z	No requirements
A	20
0	0
2	-20
3	-30
4	-40
5	-50
6	-60
7	-70
8	-80
9	-90
10	-100

Symbol	Minimum tensile strength of the welded joint
	MPa
43S	430
49S	490
55S	550
57S	570

Two run technique

**S 49S 2 AB SU32**

Type of flux	Symbol
Manganese-silicate	MS
Calcium-silicate	CS
Calcium-magnesium oxides	CG
Calcium-magnesium basic oxides	CB
Calcium-magnesium oxides with iron	CI
Calcium-magnesium basic oxides with iron	IB
Zirconium-silicate	ZS
Rutile-silicate	RS
Alumina-rutile	AR
Alumina-basic	AB
Alumina-silicate	AS
Alumina-fluoride-basic	AF
Fluoride-basic	FB
Any other composition	Z

Symbol	Chemical composition (% by mass) a) b)									
	C	Si	Mn	P	S	Mo	Ni	Cr	Cu	
SU11	0,15	0,15	0,20-0,90	0,025	0,025	0,15	0,15	0,15	0,40	
SU12	0,15	0,10-0,60	0,20-0,90	0,025	0,025	0,15	0,15	0,15	0,40	
SU21	0,05-0,15	0,10-0,35	0,80-1,25	0,025	0,025	0,15	0,15	0,15	0,40	
SU22	0,15	0,15	0,80-1,40	0,025	0,025	0,15	0,15	0,15	0,40	
SU23	0,18	0,15-0,60	0,80-1,40	0,025	0,025	0,15	0,15	0,15	0,40	
SU24 c	0,06-0,19	0,35-0,75	0,90-1,40	0,025	0,025	0,15	0,15	0,15	0,40	
SU25	0,06-0,16	0,35-0,75	0,90-1,40	0,030	0,030	0,15	0,15	0,15	0,40	
SU31	0,06-0,15	0,80-1,15	1,40-1,85	0,030	0,030	0,15	0,15	0,15	0,40	
SU32	0,15	0,05-0,60	1,30-1,90	0,025	0,025	0,15	0,15	0,15	0,40	
SU33	0,15	0,15	1,30-1,90	0,025	0,025	0,15	0,15	0,15	0,40	
SU41	0,20	0,15	1,60-2,30	0,025	0,025	0,15	0,15	0,15	0,40	
SU42	0,15	0,15-0,65	1,50-2,30	0,025	0,025	0,15	0,15	0,15	0,40	
SU51	0,15	0,15	2,20-2,80	0,025	0,025	0,15	0,15	0,15	0,40	
SU1M3	0,15	0,025	0,20-1,00	0,025	0,025	0,40-0,65	0,15	0,15	0,40	
SU2M1	0,15	0,025	0,80-1,40	0,025	0,025	0,15-0,40	0,15	0,15	0,40	
SU3M1	0,15	0,025	1,30-1,90	0,025	0,025	0,15-0,40	0,15	0,15	0,40	
SU2M3	0,17	0,025	0,80-1,40	0,025	0,025	0,40-0,65	0,15	0,15	0,40	
SU3M3	0,17	0,025	1,20-1,90	0,025	0,025	0,40-0,65	0,15	0,15	0,40	
SU4M1	0,15	0,025	1,60-2,30	0,025	0,025	0,15-0,40	0,15	0,15	0,40	
SU4M3	0,17	0,025	1,60-2,30	0,025	0,025	0,40-0,65	0,15	0,15	0,40	
SU4M31	0,05-0,15	0,50-0,80	1,60-2,10	0,025	0,025	0,40-0,60	0,15	0,15	0,40	
SU5M3	0,15	0,25	2,20-2,80	0,025	0,025	0,40-0,65	0,15	0,15	0,40	
SUN2	0,15	0,30	0,75-1,40	0,020	0,020	0,15	0,75-1,25	0,20	0,40	
SUN21	0,12	0,40-0,80	0,80 - 1,40	0,020	0,020	0,15	0,75 - 1,25	0,20	0,40	
SUN3	0,15	0,25	0,80 - 1,40	0,020	0,020	0,15	1,20 - 1,80	0,20	0,40	
SUN31	0,15	0,25	1,30 - 1,90	0,020	0,020	0,15	1,20 - 1,80	0,20	0,40	
SUN5	0,15	0,30	0,75 - 1,40	0,020	0,020	0,15	1,80 - 2,90	0,20	0,40	
SUN7	0,15	0,30	0,60 - 1,40	0,020	0,020	0,15	2,40 - 3,80	0,20	0,40	
SUCC	0,15	0,30	0,80 - 1,90	0,030	0,030	0,15	0,15	0,30 - 0,60	0,20 - 0,45	
SUNCC1	0,12	0,20-0,35	0,35 - 0,65	0,025	0,030	0,15	0,40 - 0,80	0,50 - 0,80	0,20 - 0,45	
SUNCC3	0,15	0,30	0,80 - 1,90	0,030	0,030	0,15	0,05 - 0,80	0,50 - 0,80	0,30 - 0,55	
SUN1M3	0,10-0,18	0,20	1,70 - 2,40	0,025	0,025	0,40 - 0,65	0,40 - 0,80	0,20	0,35	
SUN2M1	0,12	0,05-0,30	1,20 - 1,60	0,020	0,020	0,10 - 0,30	0,75 - 1,25	0,20	0,40	
SUN2M3	0,15	0,25	0,80 - 1,40	0,020	0,020	0,40 - 0,65	0,80 - 1,20	0,20	0,40	
SUN2M31	0,15	0,25	1,30 - 1,90	0,020	0,020	0,40 - 0,65	0,80 - 1,20	0,20	0,40	
SUN2M32	0,15	0,25	1,60 - 2,30	0,020	0,020	0,40 - 0,65	0,80 - 1,20	0,20	0,40	
SUN3M3	0,15	0,25	0,80 - 1,40	0,020	0,020	0,40 - 0,65	1,20 - 1,80	0,20	0,40	
SUN3M31	0,15	0,25	1,30 - 1,90	0,020	0,020	0,40 - 0,65	1,20 - 1,80	0,20	0,40	
SUN4M1	0,12-0,19	0,10-0,30	0,60 - 1,00	0,015	0,030	0,10 - 0,30	1,60 - 2,10	0,20	0,35	
SUZ	d	Andere vereinbarte Zusammensetzungen								

- a) The electrode shall be analyzed for the specific elements for which values are shown in this table. If the presence of other elements is indicated, in the course of this work, the amount of those elements shall be determined to ensure that their total (excluding iron) does not exceed 0,50 percent.
- b) Single values shown in the table are maximum values.

## GUIDE TO EN ISO 14171-B SOLID WIRE ELECTRODES, TUBULAR CORED ELECTRODES AND ELECTRODE/FLUX COMBINATIONS FOR SUBMERGED ARC WELDING OF NON ALLOY AND FINE GRAIN STEELS

multi-run welding

Two run technique

**S 55A 8U AB TUN7**

Symbol	Minimum yield strength a)	Tensile strength	Minimum elongation b)
	MPa	MPa	%
43X	330	430 - 600	20
49X	390	490 - 670	18
55X	460	550 - 740	17
57X	490	570 - 770	17

- a) X is "A" or "P", where "A" indicates testing in the as-welded condition and "P" indicates testing in the post weld heat-treated condition.
- b) For yield strength, the 0,2 % proof strength (Rp0,2) is used.
- c) Gauge length is equal to five times the test specimen diameter.

Symbol	Impact Energy Charpy-V Temp °C for 27J min.
Z	No requirements
A	20
0	0
2	-20
3	-30
4	-40
5	-50
6	-60
7	-70
8	-80
9	-90
10	-100

Symbol	Minimum tensile strength of the welded joint
	MPa
43S	430
49S	490
55S	550
57S	570

**S 49S 8U AB TUN**

Type of flux	Symbol
Manganese-silicate	MS
Calcium-silicate	CS
Calcium-magnesium oxides	CG
Calcium-magnesium basic oxides	CB
Calcium-magnesium oxides with iron	CI
Calcium-magnesium basic oxides with iron	IB
Zirconium-silicate	ZS
Rutile-silicate	RS
Alumina-rutile	AR
Alumina-basic	AB
Alumina-silicate	AS
Alumina-fluoride-basic	AF
Fluoride-basic	FB
Any other composition	Z

Symbol	Chemical composition (% by mass) a) b)									
	C	Mn	Si	S	P	Cr	Ni	Mo	Cu	other
TU3M	0,15	1,80	0,90	0,035	0,035	-	-	-	0,35	-
TU2M3	0,12	1,00	0,80	0,030	0,030	-	-	0,40-0,65	0,35	-
TU2M31	0,12	1,40	0,80	0,030	0,030	-	-	0,40-0,65	0,35	-
TU4M3	0,15	2,10	0,80	0,030	0,030	-	-	0,40-0,65	0,35	-
TU3M3	0,15	1,60	0,80	0,030	0,030	-	-	0,40-0,65	0,35	-
TUN2	0,12	1,60	0,80	0,025	0,030	0,15	0,75-1,10	0,35	0,35	Ti+V+Zr: 0,05
TUN5	0,12	1,60	0,80	0,025	0,030	-	2,00-2,90	-	0,35	-
TUN7	0,12	1,60	0,80	0,025	0,030	0,15	2,80-3,80	-	0,35	-
TUN4M1	0,14	1,60	0,80	0,025	0,030	-	1,40-2,10	0,10-0,35	0,35	-
TUN2M1	0,12	1,60	0,80	0,025	0,030	-	0,70-1,10	0,10-0,35	0,35	-
TUN3M2	0,12	0,70-1,50	0,80	0,030	0,030	0,15	0,90-1,70	0,55	0,35	-
TUN1M3	0,17	1,25-2,25	0,80	0,030	0,030	-	0,40-0,80	0,40-0,65	0,35	-
TUN2M3	0,17	1,25-2,25	0,80	0,030	0,030	-	0,70-1,10	0,40-0,65	0,35	-
TUN1C2	0,17	1,60	0,80	0,035	0,030	0,60	0,40-0,80	0,25	0,35	Ti + V + Zr: 0,03
TUN5C2M3	0,17	1,20-1,80	0,80	0,020	0,020	0,65	2,00-2,80	0,30-0,80	0,50	-
TUN4C2M3	0,14	0,80-1,85	0,80	0,030	0,030	0,65	1,50-2,25	0,60	0,40	-
TUN3	0,10	0,60-1,60	0,80	0,030	0,030	0,15	1,25-2,00	0,35	0,30	Ti + V + Zr: 0,03
TUN4M2	0,10	0,90-1,80	0,80	0,020						
	0,020	0,35	1,40-2,10	0,25-0,65	0,30					Ti + V + Zr: 0,03
TUN4M3	0,10	0,90-1,80	0,80	0,020	0,020	0,65	1,80-2,60	0,20-0,70	0,30	Ti + V + Zr: 0,03
TUN5M3	0,10	1,30-2,25	0,80	0,020	0,020	0,8/0	2,00-2,80	0,30-0,80	0,30	Ti + V + Zr: 0,03
TUN4M21	0,12	1,60-2,350	0,50	0,015	0,015	0,40	1,40-2,10	0,20-0,50	0,30	Ti: 0,03 V: 0,02 Zr: 0,02
TUN4M4	0,12	1,60-2,50	0,50	0,015	0,015					
	0,40	1,40-2,10	0,70-1,00	0,30						Ti: 0,03 V: 0,02 Zr: 0,02
TUNCC	0,12	0,50-1,60	0,80	0,030	0,035	0,45-0,70	0,40-0,80	-	0,30-0,75	-
TUZ	Any agreed composition									

- a) The electrode shall be analyzed for the specific elements for which values are shown in this table. If the presence of other elements is indicated, in the course of this work, the amount of those elements shall be determined to ensure that their total (excluding iron) does not exceed 0,50 percent.
- b) Single values shown in the table are maximum values.
- c) Manganese in the N2 and N5 designated weld metals may be 1,80% maximum when the carbon is restricted to 0,10% maximum.

## GUIDE TO EN ISO 14171-A/B SOLID WIRE ELECTRODES, TUBULAR CORED ELECTRODES AND ELECTRODE/FLUX COMBINATIONS FOR SUBMERGED ARC WELDING OF NON ALLOY AND FINE GRAIN STEELS

Supplementary Info:  
COMPARISON OF SOLID ELECTRODE DESIGNATIONS

AWS A5.23/A5.23M Classification	EL8e		S1		(SU11)		NOTES:
	ISO 14171-A	ISO 14171-B	ISO 24598-A	ISO 24598-B	ISO 26304-A	ISO 26304-B	
EL8e	S1	(SU11)	-	-	-	-	<p>a) The requirements for the equivalent classifications shown are not necessarily identical in every respect.</p> <p>b) ISO 14171, Welding consumables - Wire electrodes and wire-flux combinations for submerged arc welding of non alloy and fine grain steels - Classification, is a cohabitation document providing for classification utilizing a system based upon the yield strength and the average impact energy for all-weld metal of 47 J (ISO 14171-A), or utilizing a system based upon the tensile strength and the average impact energy for all-weld metal of 27 J (ISO 14171-B).</p> <p>c) ISO 24598 Welding consumables - Solid wire electrodes, tubular cored electrodes, and electrode-flux combinations for submerged arc welding of creep-resisting steels - Classification, is a cohabitation document. The classification according to system A is mainly based on EN 12070. The classification according to system B is mainly based upon standards used around the Pacific Rim. This ISO document is still under review and has not yet been released for publication.</p> <p>d) ISO 26304, Welding consumables - Solid wire electrodes, tubular cored electrodes and electrode/flux combinations for submerged arc welding of high strength steels - Classification, is a cohabitation document. The classification according to system A is mainly based on EN 14295. The classification according to system B is mainly based upon standards used around the Pacific Rim. This ISO document is still under review and has not yet been released for publication.</p> <p>e) These solid wire electrode classifications also appear in AWS A5.17/A5.17M.</p>
EL8Ke	S1Si1	SU12	-	-	-	-	
EL12e	S1	SU11	-	-	-	-	
EM11Ke	-	SU25	-	-	-	-	
EM12e	S2	SU22	-	-	-	-	
EM12Ke	S2Si	SU21	-	-	-	-	
EM13K e	S2Si2	SU25	-	-	-	-	
EM14Ke	-	SU24	-	-	-	-	
EM15K e	S2Si	(SU21)	-	-	-	-	
EH10K e	S3Si	SU32	-	-	-	-	
EH11K e	-	SU31	-	-	-	-	
EH12K e	S4Si	SU42	-	-	-	-	
EH114e	-	SU41	-	-	-	-	
EA1	-	SU1M3	(SMo)	SU1M3	-	-	
EA1TiB	-	-	-	-	-	-	
EA2	S2Mo	SU2M3	SMo	SU2M3	-	-	
EA3	S4Mo	SU4M3	-	SU4M3	-	-	
EA3K	-	SU4M31	-	SU4M32	-	-	
EA4	S3Mo	SU3M3	SMnMo	SU3M3	-	-	
EB1	-	-	-	SUCM	-	-	
EB2g	-	-	SCrMo1	SU1CM	-	-	
EB2H	-	-	-	Su1CMVH	-	-	
EB3g	-	-	SCrMo2	SU2C1M	-	-	
EB5	-	-	-	SUC1MH	-	-	
EB6	-	-	SCrMo5	SU5CM	-	-	
EB6H	-	-	-	SU5CMH	-	-	
EB8	-	-	SCrMo9	SU9C1M	-	-	
EB9	-	-	-	SU9C1MV	-	-	
ENi1	S2Ni1	SUN2	-	-	-	-	
ENi1K	-	SUN21	-	-	-	-	
ENi2	-	SUN5	-	-	-	-	
ENi3	S2Ni3	SUN7	-	-	-	-	
ENi4	-	SUN4M1	-	-	-	SUN4M1	
ENi5	-	SUN2M1	-	-	-	SUN2M1	
EF1					S2Ni1Mo	SUN2M2	
EF2						SUN1M3	
EF3						SUN2M33	
EF4						SUN1C1M1	
EF5						SUN5CM3	
EF6						SUN4C1M3	
EM2i						SUN3M2	
EM3i						SUN4C1M2	
EM4i						SUN5C1M3	
EW	SUNCC1						



## GUIDE TO EN ISO 14172: GMAW ELECTRODES FOR MANUAL METAL ARC WELDING OF NICKEL AND NICKEL ALLOY.

E = Electrode

The symbol for the chemical composition of the all-weld metal shall comprise "Ni" plus for digits as shown in Tab 1 Norm

The first digit is an indicator of the class of alloy deposited:

- 2 No significant alloy addition
- 4 Significant copper addition
- 6 Significant chromium addition, with iron less than 25% (NiCrFe and NiCrMo alloys)
- 8 Significant chromium addition, with iron more than 25% (NiFeCr alloys)
- 10 Significant molybdenum addition without significant chromium addition (NiMo alloys)

Optional chemical symbol of covered electrode

**E                      Ni 61 82                      (NiCr15Fe6Mn)**

Alloy code			Chemical composition % (m/m)														
Num. Iso	Numerically AWS	chemically	C	Mn	Fe	Si	Cu	Ni	Co	Al	Ti	Cr	Nb	Mo	V	W	Sonstige
<b>Nickel</b>																	
Ni 2061	ENi-1	NiTi3	0,10	0,70	0,70	1,20	0,20	≥ 92,0	-	1,0	1,0-4,0	-	-	-	-	-	-
<b>Nickel-Copper</b>																	
Ni 4060	ENiCu-7	NiCu30Mn3Ti	0,15	4,0	2,5	1,5	27,0 - 34,0	≥ 62,0	-	1,0	1,0	-	-	-	-	-	-
Ni 4061		Ni-Cu27Mn3NbTi	0,15	4,0	2,5	1,3	24,0 - 31,0	≥ 62,0	-	1,0	1,5	-	3,0	-	-	-	-
<b>Nickel-Chromium</b>																	
Ni 6082		NiCr20Mn3Nb	0,10	2,0 - 6,0	4,0	0,8	0,5	≥ 63,0	-	-	0,5	18,0 - 22,0	1,5 - 3,0	2,0	-	-	-
Ni 6172		NiCr50Nb	0,10	1,5	1,0	1,0	0,25	≥ 41,0	-	-	-	48,0-52,0	1,0-2,5	-	-	-	-
Ni 6231	ENiCrW-Mo-1	NiCr22W14Mo	0,05-0,10	0,3 -1,0	3,0	0,3 - 0,7	0,5	≥ 45,0	5,0	0,5	0,1	20,0 - 24,0	-	1,0 - 3,0	-	13,0 -15,0	-
<b>Nickel-Chromium-Iron</b>																	
Ni 6025		NiCr25Fe10AlY	0,10 - 0,25	0,50	8,0 - 11,0	0,8	-	≥ 55,0	-	1,5 - 2,2	0,3	24,0 - 26,0	-	-	-	-	0,15Y
Ni 6045		NiCr27Fe23Si	0,05-0,20	2,5	21,0-25,0	2,5-3,0	0,30	≥ 38,0	1,0	0,30	-	26,0-29,0	-	-	-	-	0,04P 0,03S
Ni 6062	ENiCrFe-1	NiCr15Fe8Nb	0,08	3,5	11,0	0,8	0,5	≥ 62,0	-	-	-	13,0 - 17,0	0,50 - 4,0	-	-	-	-
Ni 6133	ENiCrFe-2	NiCr16Fe12NbMo	0,10	1,0 - 3,5	12,0	0,8	0,5	≥ 62,0	-	-	-	13,0 - 17,0	0,50 - 3,0	0,50 - 2,5	-	-	-
Ni 6093	ENiCrFe-4	NiCr15Fe8NbMo	0,20	1,0 - 5,0	12,0	1,0	0,5	≥ 60,0	-	-	-	13,0 - 17,0	1,0 - 3,5	1,0 - 3,5	-	-	-
Ni 6094	ENiCrFe-9	NiCr14Fe4NbMo	0,15	1,0 - 4,5	12,0	0,8	0,5	≥ 55,0	-	-	-	12,0 - 17,0	0,5 - 3,0	2,5 - 5,5	-	1,5	-
Ni 6095	ENiCrFe-10	NiCr15Fe8NbMoW	0,20	1,0 - 3,5	12,0	0,8	0,5	≥ 55,0	-	-	-	13,0 - 17,0	1,0 - 3,5	1,0 - 3,5	-	1,5 - 3,5	-
Ni 6132		NiCr15Fe9Nb	0,08	3,5	11,0	0,75	0,50	≥ 62,0	-	-	-	13,0 - 17,0	1,5-4,0	-	-	-	0,03P 0,015S
Ni 6133		NiCr16Fe12NbMo	0,10	1,0-3,5	12,0	0,8	0,5	≥ 62,0	-	-	-	13,0 - 17,0	0,5-3,0	0,5-2,5	-	-	-
Ni 6152	ENiCrFe-7	NiCr30Fe9Nb	0,05	5,0	7,0-12,0	0,8	0,5	≥ 50,0	-	0,5	0,5	28,0 - 31,5	1,0 - 2,5	0,5	-	-	-
Ni 6182	ENiCrFe-3	NiCr15Fe6Mn	0,10	5,0 - 10,0	10,0	1,0	0,5	≥ 60,0	-	-	1,0	13,0 - 17,0	1,0 - 3,5	-	-	-	*0,3 max. Ta
Ni 6333		NiCr25Fe16CoNbW	0,10	1,2 - 20	≥ 16,0	0,8 - 1,2	0,5	44,0 - 47,0	2,5 - 3,5	-	-	24,0 - 26,0	-	2,5 - 3,5	-	2,5 - 3,5	-
Ni 6701		NiCr36Fe7Nb	0,35 - 0,50	0,5 - 2,0	7,0	0,50 - 2,0	-	42,0 - 48,0	-	-	-	33,0 - 39,0	0,8 - 1,8	-	-	-	-
Ni 6702		NiCr28Fe6W	0,35 - 0,50	0,5 - 1,5	6,0	0,50 - 2,0	-	47,0 - 50,0	-	-	-	27,0 - 30,0	-	-	-	4,0 - 5,5	-
Ni 6704		NiCr25Fe10Al3YC	0,15 - 0,30	0,5	8,0 - 11,0	0,8	-	≥ 55,0	-	1,8 - 2,8	0,3	24,0 - 26,0	-	-	-	-	0,15Y
Ni 8025		NiCr29Fe30Mo	0,06	1,0 - 3,0	30,0	0,7	1,5 - 3,0	35,0 - 40,0	-	0,1	1,0	27,0 - 31,0	1,0	2,5 - 4,5	-	-	*or Nb
Ni 8165		NiCr25Fe30Mo	0,03	1,0 - 3,0	30,0	0,7	1,5 - 3,0	37,0 - 42,0	-	0,1	1,0	23,0 - 27,0	-	3,5 - 7,5	-	-	-
<b>Nickel-Molybdenum</b>																	
Ni 1001	ENiMo-1	NiMo28Fe5	0,07	1,0	4,0 - 7,0	1,0	0,5	≥ 55,0	2,5	-	-	1,0	-	26 - 30	0,6	1,0	-
Ni 1004	ENiMo-3	NiMo25Cr5Fe5	0,12	1,0	4,0 - 7,0	1,0	0,5	≥ 60,0	-	-	-	2,5 - 5,0	-	23 - 27	0,6	1,0	-
Ni 1008	ENiMo-8	NiMo19WCr	0,10	1,5	10,0	0,8	0,5	≥ 60,0	-	-	-	0,5 - 3,5	-	17 - 20	-	2,0 - 4,0	-
Ni 1009	ENiMo-9	NiMo20WCu	0,10	1,5	7,0	0,8	0,3 - 1,3	≥ 62,0	-	-	-	-	-	18 - 22	-	2,0 - 4,0	-

## GUIDE TO EN ISO 14172: GMAW ELECTRODES FOR MANUAL METAL ARC WELDING OF NICKEL AND NICKEL ALLOY.

<b>E</b>	<b>Ni 61 82</b>	<b>(NiCr15Fe6Mn)</b>
----------	-----------------	----------------------

Part 2

Alloy code			Chemical composition % (m/m)														
Numerically Iso	Numerically AWS	chemically	C	Mn	Fe	Si	Cu	Ni	Co	Al	Ti	Cr	Nb	Mo	V	W	others
<b>Nickel-Molybdenum</b>																	
Ni 1062		NiMo24Cr8Fe6	0,02	1,0	4,0 - 7,0	0,7	-	≥ 60,0	-	-	-	6,0 - 9,0	-	22 - 26	-	-	-
Ni 1066	ENiMo-7	NiMo28	0,02	2,0	2,2	0,2	0,5	≥ 64,5	-	-	-	1,0	-	26 - 30	-	1,0	-
Ni 1067	ENiMo-10	NiMo30Cr	0,02	2,0	1,0 - 3,0	0,2	0,5	≥ 62,0	3,0	-	-	1,0 - 3,0	-	27 - 32	-	3,0	-
Ni 1069		NiMo28Fe4Cr	0,02	1,0	2,0 - 5,0	0,7	-	≥ 65,0	1,0	0,5	-	0,5 - 1,5	-	26 - 30	-	-	-
<b>Nickel-Chromium-Molybdenum</b>																	
Ni 6002	ENiCrMo-2	NiCr22Fe18Mo	0,05 - 0,15	1,0	17 - 20	1,0	0,5	≥ 45,0	0,5 - 2,5	-	-	20 - 23	-	8,0 - 10	-	0,2 - 1,0	-
Ni 6012		NiCr22Mo9	0,03	1,0	3,5	0,7	0,5	≥ 58,0	-	0,4	0,4	20 - 23	1,5	8,5 - 10,5	-	-	-
Ni 6022	ENiCrMo-10	NiCr21Mo13W3	0,02	1,0	2,0 - 6,0	0,2	0,5	≥ 49,0	2,5	-	-	20 - 22,5	-	12,5 - 14,5	0,4	2,5 - 3,5	-
Ni 6024		NiCr26Mo14	0,02	0,5	1,5	0,2	0,5	≥ 55,0	-	-	-	25 - 27	-	13,5 - 15,0	-	-	-
Ni 6030	ENiCrMo-11	NiCr29M- o5F105e15 W2	0,03	1,5	13 - 17	1,0	1,0 - 2,4	≥ 36,0	5,0	-	-	28 - 31,5	0,3 - 1,5	4,0 - 6,0	-	1,5 - 4,0	-
Ni 6059	ENiCrMo-13	NiCr23Mo16	0,02	1,0	1,5	0,2	-	≥ 56,0	-	-	-	22 - 24	-	15,0 - 16,5	-	-	-
Ni 6200	ENiCrMo-17	NiCr23Mo16Cu2	0,02	1,0	3,0	0,2	1,3 - 1,9	≥ 45,0	2,0	-	-	20 - 27	-	15,0 - 17,0	-	-	-
Ni 6205		NiCr25Mo16	0,02	0,5	5,0	0,2	2,0	≥ 50,0	-	0,4	-	22 - 27	-	13,5 - 16,5	-	-	-
Ni 6275	ENiCrMo-5	NiCr15M- o16Fe5W3	0,01	1,0	4,0 - 7,0	1,0	0,5	≥ 50,0	2,5	-	-	14,5 - 16,5	-	15,0 - 18,0	0,4	3,0 - 4,5	-
Ni 6276	ENiCrMo-4	Ni Cr15Mo- 15Fe6W4	0,02	1,0	4,0 - 7,0	0,2	0,5	≥ 50,0	2,5	-	-	14,5 - 16,5	-	15,0 - 17,0	0,4	3,0 - 4,5	-
Ni 6452		NiCr19Mo15	0,025	2,0	1,5	0,4	0,5	≥ 56,0	-	-	-	18,0 - 20,0	0,4	14,0 - 16,0	0,4	-	-
Ni 6455	ENiCrMo-7	NiCr16Mo15Ti	0,02	1,5	3,0	0,2	0,5	≥ 56,0	2,0	-	0,7	14,0 - 18,0	-	14,0 - 17,0	-	0,5	-
Ni 6620	ENiCrMo-6	NiCr14Mo7Fe	0,10	2,0 - 4,0	10,0	1,0	0,5	≥ 55,0	-	-	-	12,0 - 17,0	0,5 - 2,0	5,0 - 9,0	-	1,0 - 2,0	-
Ni 6625	ENiCrMo-3	NiCr22Mo9Nb	0,10	2,0	7,0	0,8	0,5	≥ 55,0	-	-	-	20,0 - 23,0	3,0 - 4,2	8,0 - 10,0	-	-	-
Ni 6627	ENiCrMo-12	NiCr21MoFeNb	0,03	2,2	5,0	0,7	0,5	≥ 57,0	-	-	-	20,5 - 22,5	1,0 - 2,8	8,8 - 10,0	-	0,5	-
Ni 6650		NiCr20F- e14Mo11WN	0,03	0,7	12 - 15	0,6	0,5	≥ 44,0	1,0	0,5	-	19,0 - 22,0	0,3	10,0 - 13,0	-	1,0 - 2,0	0,15 N 0,02 S
Ni 6686	ENiCrMo-14	NiCr21Mo16W4	0,02	1,0	5,0	0,3	0,5	≥ 49,0	-	-	0,3	19,0 - 23,0	-	15,0 - 17,0	-	3,0 - 4,4	-
Ni 6985	ENiCrMo-9	NiCr22Mo7Fe19	0,02	1,0	18 - 21	1,0	1,5 - 2,5	≥ 45,0	5,0	-	-	21,0 - 23,5	1,0	6,0 - 8,0	-	1,5	-
<b>Nickel-Chromium-Cobalt-Molybdenum</b>																	
Ni 6617	ENiCrCoMo-1	NiCr22Co12Mo	0,05 - 0,15	3,0	5,0	1,0	0,5	≥ 45,0	9,0 - 15	1,5	0,6	20 - 26	1,0	8,0 - 10,0	-	-	-

a Individual values for all elements except nickel are maximum values. Two values indicate the minimum and maximum values for a range.

b Up to 1% of the nickel content may be cobalt unless otherwise specified. Lower cobalt levels may be required for certain applications and should be agreed upon between the parties.

c Up to 20% of the niobium content may be tantalum.

d The total content of unspecified elements shall not exceed 0.5%, excluding cobalt and tantalum.

e Phosphorus 0.020% max, sulfur 0.015% max, unless otherwise specified.

f Boron 0.005% max, Zr 0.020%.

## Minimum tensile properties of the all-weld metal

Numerical symbol	Minimum 0,2 % proof strength MPa	Minimum 0,2 % tensile strength MPa	Minimum elongation (5d) a %
<b>Nickel</b>			
Ni 2061	200	410	18
<b>Nickel-Copper</b>			
Ni 4060; Ni 4061	200	480	27
<b>Nickel-Chromium</b>			
Ni 6082	360	600	22
Ni 6231	350	620	18
<b>Nickel-Chromium-Iron</b>			
Ni 6025	400	690	12
Ni 6062; Ni 6092	360	550	27
Ni 6093; Ni 6094; Ni 6095	360	650	18
Ni 6152; Ni 6182	360	550	27
Ni 6333	360	550	18
Ni 6701; Ni 6702	450	650	8
Ni 6704	400	690	12
Ni 8025; Ni 8165	240	550	22
<b>Nickel-Molybdenum</b>			
Ni 1001; Ni 1004	400	690	22
Ni 1008; Ni 1009	360	650	22
Ni 1062	360	550	18

Numerical symbol	Minimum 0,2 % proof strength MPa	Minimum 0,2 % tensile strength MPa	Minimum elongation (5d) a %
<b>Nickel-Molybdenum</b>			
Ni 1066	400	690	22
Ni 1067	350	690	22
Ni 1069	360	550	20
<b>Nickel-Chromium-Molybdenum</b>			
Ni 6002	380	650	18
Ni 6012	410	650	22
Ni 6022; Ni 6024	350	690	22
Ni 6030	350	585	22
Ni 6200; Ni 6275; Ni 6276	400	690	22
Ni 6205; Ni 6452	350	690	22
Ni 6455	300	690	22
Ni 6620	300	620	32
Ni 6625	420	760	27
Ni 6627	400	650	32
Ni 6650	420	660	30
Ni 6686	350	690	27
Ni 6985	350	620	22
<b>Nickel-Chromium-Cobalt-Molybdenum</b>			
Ni 6617	400	620	22

## GUIDE TO EN ISO 14174: FLUXES FOR SUBMERGED ARC WELDING AND ELECTROSLAG WELDING

**S** = Flux for Submerged Arc welding  
**ES** = Flux for Electroslag welding

Symbol	method of manufacture
F	fused flux
A	agglomerated flux
M	mixed flux

Symbol	Typ of current
DC	fused flux
AC	agglomerated flux

Symbol	Hydrogen content
H5	fused flux
H10	agglomerated flux
H15	mixed flux

**S F CS 1 67 AC H10**

Symbol	Characteristic chemical Constituents	Limit of constituent % by mass
MS (Manganese-silicate)	MnO + SiO <sub>2</sub> CaO	≥ 50 ≤ 15
CS (Calcium-silicate)	CaO + MgO + SiO <sub>2</sub> CaO + MgO	≥ 55 ≤ 15
CG (Calcium-magnesium)	CaO + MgO CO <sub>2</sub> Fe	5 - 50 ≥ 2 ≤ 10
CB (Calcium-magnesium basic)	CaO + MgO CO <sub>2</sub> Fe	30 - 80 ≥ 2 ≤ 10
CG-I (Calcium-magnesium with iron)	CaO + MgO CO <sub>2</sub> Fe	5 - 45 ≥ 2 15 - 60
CB-I (Calcium-magnesium basic with iron)	CaO + MgO CO <sub>2</sub> Fe	10 - 70 ≥ 2 15 - 60
GS (Magnesium-silicate)	MgO + SiO <sub>2</sub> Al <sub>2</sub> O <sub>3</sub> CaO + CaF	≥ 42 ≤ 20 ≤ 14
ZS (Zirconium-silicate)	ZrO <sub>2</sub> + SiO <sub>2</sub> + MnO ZrO <sub>2</sub>	≥ 45 ≥ 15
RS (Rutile-silicate)	TiO <sub>2</sub> + SiO <sub>2</sub> TiO <sub>2</sub>	≥ 50 ≥ 20
AR (Aluminate-rutile)	Al <sub>2</sub> O <sub>3</sub> + TiO <sub>2</sub>	≥ 40
BA (Basic-alumina)	Al <sub>2</sub> O <sub>3</sub> + CaF <sub>2</sub> + SiO <sub>2</sub> CaO SiO <sub>2</sub>	≥ 55 ≤ 8 ≤ 20
AAS (Acid-aluminium-silicate)	Al <sub>2</sub> O <sub>3</sub> + SiO <sub>2</sub> CaF <sub>2</sub> + MgO	≥ 50 ≥ 20
AB (Aluminate-basic)	Al <sub>2</sub> O <sub>3</sub> + CaO + MgO Al <sub>2</sub> O <sub>3</sub> CaF <sub>2</sub>	≥ 40 ≥ 20 ≤ 22
AS (Aluminate-silicate)	Al <sub>2</sub> O <sub>3</sub> + SiO <sub>2</sub> + ZrO <sub>2</sub> CaF <sub>2</sub> + MgO ZrO <sub>2</sub>	≥ 40 ≥ 30 ≥ 5
AF (Aluminate-fluoride-basic)	Al <sub>2</sub> O <sub>3</sub> + CaF <sub>2</sub>	≥ 70
FB (Fluoride-basic)	CaO + MgO + CaF <sub>2</sub> + MnO SiO <sub>2</sub> CaF <sub>2</sub>	≥ 50 ≤ 20 ≥ 15

## Symbol for metallurgical behaviour of fluxes class 1

Metallurgical behavior	Symbol	Contribution from flux on all weld metal % by mass
Burn-out a	1	≥ 0,7
	2	0,5 - 0,7
	3	0,3 - 0,5
	4	0,1 - 0,3
Neutral	5	0,0 - 0,1
Pick-up	6	0,1 - 0,3
	7	0,3 - 0,5
	8	0,5 - 0,7
	9	≥ 0,7

## Symbol for metallurgical behaviour of fluxes class 2

Electrode to be used			
Product/Process	Class	ISO 14343-A	ISO 14343-B
S	2	S 19 9 L	SS308L
S	2B	B 19 9 L	BS308L
ES	2B	B 19 9 L	BS308L

## Symbol for metallurgical behaviour of fluxes class 2 B

Metallurgical behavior	Symbol	Contribution from flux on all weld metal % by mass			
		C	Si	Cr	Nb
Burn-out a	1	> 0,020	> 0,7	> 2,0	> 0,20
	2	symbol not used	0,5 - 0,7	1,5 - 2,0	0,15 - 0,20
	3	0,010 - 0,020	0,3 - 0,5	1,0 - 1,5	0,10 - 0,15
	4	symbol not used	0,1 - 0,3	0,5 - 1,0	0,05 - 0,10
Neutral	5	0,000 - 0,010	0,0 - 0,1	0,0 - 0,5	0,00 - 0,05
Pick-up	6	symbol not used	0,1 - 0,3	0,5 - 1,0	0,05 - 0,10
	7	0,010 - 0,020	0,3 - 0,5	1,0 - 1,5	0,10 - 0,15
	8	symbol not used	0,5 - 0,7	1,5 - 2,0	0,15 - 0,20
	9	> 0,020	> 0,7	> 2,0	> 0,20

Symbol	Application
1	These are fluxes for submerged arc welding of non alloy and fine grain steels, high strength steels, creep resisting steels, and atmospheric corrosion resisting steels
2	These are fluxes for joint welding of stainless and heat-resisting steels and/or nickel and nickel-based alloys and corrosion-resistant overlay welding 1). Fluxes of these classes can contain alloying elements compensating for the burn-out.
2b	Like 2 but strip cladding
3	These are fluxes mainly for hardfacing overlay welding by transfer of alloying elements from the flux, such as C, Cr or Mo, or using unalloyed fluxes in combination with low, medium or high alloyed wire/strip electrodes
4	These are other fluxes for which classes 1 to 3 are not applicable, e.g. fluxes for copper base alloys

## GUIDE TO EN ISO 14175: GASES AND GAS MIXTURES FOR FUSION WELDING AND ALLIED PROCESSES

## ISO 14175 – M21

Symbol		Components in nominal percentage of volume					
		Oxidizing		Inert		Reducing	Low reactivity
Main group	Sub group	CO2	O2	Ar	He	H2	N2
<b>I</b>	1			100			
	2				100		
	3			balance	0,5 ≤ He ≤ 95		
<b>M1</b>	1	0,5 ≤ CO2 ≤ 5		balance a		0,5 ≤ H2 ≤ 5	
	2	0,5 ≤ CO2 ≤ 5		balance a			
	3		0,5 ≤ O2 ≤ 3	balance a			
	4	0,5 ≤ CO2 ≤ 5	0,5 ≤ O2 ≤ 3	balance a			
<b>M2</b>	0	5 ≤ CO2 ≤ 15		balance a			
	1	15 ≤ CO2 ≤ 25		balance a			
	2		3 ≤ O2 ≤ 10	balance a			
	3	0,5 ≤ CO2 ≤ 5	3 ≤ O2 ≤ 10	balance a			
	4	5 ≤ CO2 ≤ 15	0,5 ≤ O2 ≤ 3	balance a			
	5	5 ≤ CO2 ≤ 15	3 ≤ O2 ≤ 10	balance a			
	6	15 ≤ CO2 ≤ 25	0,5 ≤ O2 ≤ 3	balance a			
	7	15 ≤ CO2 ≤ 25	3 ≤ O2 ≤ 10	balance a			
<b>M3</b>	1	25 ≤ CO2 ≤ 50		balance a			
	2		10 ≤ O2 ≤ 15	balance a			
	3	25 ≤ CO2 ≤ 50	2 ≤ O2 ≤ 10	balance a			
	4	5 ≤ CO2 ≤ 25	10 ≤ O2 ≤ 15	balance a			
	5	25 ≤ CO2 ≤ 50	10 ≤ O2 ≤ 15	balance a			
<b>C</b>	1	100					
	2	Rest	0,5 ≤ O2 ≤ 30				
<b>R</b>	1			balance a		0,5 ≤ H2 ≤ 15	
	2			balance a		15 ≤ H2 ≤ 50	
<b>N</b>	1						100
	2			balance a			0,5 ≤ N2 ≤ 5
	3			balance a			5 ≤ N2 ≤ 50
	4			balance a		0,5 ≤ H2 ≤ 10	0,5 ≤ N2 ≤ 5
	5					0,5 ≤ H2 ≤ 50	Rest
<b>O</b>	1		100				
<b>Z</b>	Gas mixtures containing components not listed, or mixtures outside the composition ranges listed. b)						

a) For the purpose of this classification, argon may be substituted partially or completely by helium.  
b) Two gas mixtures with the same Z-classification may not be interchangeable.

## GUIDE TO EN ISO 14341-A: WIRE ELECTRODES AND WELD DEPOSITS FOR GAS SHIELDED METAL ARC WELDING OF NON ALLOY AND FINE GRAIN STEELS

G = Is the wire electrode and/  
or deposit/gas shielded metal  
arc welding

Gases according to  
ISO 14175

**G 46 5 M21 3Si1**

Symbol	Tensile Strength MPa	Yield Strength min. MPa	Elongation min. %
38	470-600	380	20
42	500-640	420	20
46	530-680	460	20
50	560-720	500	18

Symbol	Impact Energy Charpy-V Temp °C for 47J min.
Z	No requirements
A	20
0	0
2	-20
3	-30
4	-40
5	-50
6	-60
7	-70
8	-80
9	-90
10	-100

Symbol	Chemical composition (% by mass) a) b) c)											
	C	Si	Mn	P	S	Ni	Cr	Mo	V	Cu	Al	Ti+Zr
2Si	0,06 - 0,14	0,50 - 0,80	0,90 - 1,30	0,025	0,025	0,15	0,15	0,15	0,03	0,35	0,02	0,15
3Si1	0,06 - 0,14	0,70 - 1,00	1,30 - 1,60	0,025	0,025	0,15	0,15	0,15	0,03	0,35	0,02	0,15
3Si2	0,06 - 0,14	1,00 - 1,30	1,30 - 1,60	0,025	0,025	0,15	0,15	0,15	0,03	0,35	0,02	0,15
4Si1	0,06 - 0,14	0,80 - 1,20	1,60 - 1,90	0,025	0,025	0,15	0,15	0,15	0,03	0,35	0,02	0,15
2Ti	0,04 - 0,14	0,40 - 0,80	0,90 - 1,40	0,025	0,025	0,15	0,15	0,15	0,03	0,35	0,05 - 0,20	0,05 - 0,25
2Al	0,08 - 0,14	0,30 - 0,50	0,90 - 1,30	0,025	0,025	0,15	0,15	0,15	0,03	0,35	0,35 - 0,75	0,15
3Ni1	0,06 - 0,14	0,50 - 0,90	1,00 - 1,60	0,020	0,020	0,80 - 1,50	0,15	0,15	0,03	0,35	0,02	0,15
2Ni2	0,06 - 0,14	0,40 - 0,80	0,80 - 1,40	0,020	0,020	2,10 - 2,70	0,15	0,15	0,03	0,35	0,02	0,15
2Mo	0,08 - 0,14	0,30 - 0,70	0,90 - 1,30	0,020	0,020	0,15	0,15	0,40 - 0,60	0,03	0,35	0,02	0,15
4Mo	0,06 - 0,14	0,50 - 0,80	1,70 - 2,10	0,025	0,025	0,15	0,15	0,40 - 0,60	0,03	0,35	0,02	0,15
Z b	Any other agreed composition											

**WELDING KNOW-HOW - STANDARD**

**GUIDE TO EN ISO 14341-B: WIRE ELECTRODES AND WELD DEPOSITS FOR GAS SHIELDED METAL ARC WELDING OF NON ALLOY AND FINE GRAIN STEELS**

G = Is the wire electrode and/ or deposit/gas shielded metal arc welding



Symbol	Minimum yield strength a)	Tensile strength	Minimum elongation b)
	MPa	MPa	%
43X	330	430 -600	20
49X	390	490 -670	18
55X	460	550 -740	17
57X	490	570 -770	17

- a) X is "A" or "P", where "A" indicates testing in the as-welded condition and "P" indicates testing in the post weld heat-treated condition.
- b) For yield strength, the 0,2 % proof strength (Rp0,2) is used.
- c) Gauge length is equal to five times the test specimen diameter.

Symbol	Impact Energy Charpy-V Temp °C for 27J min.
Z	No requirements
A	20
0	0
2	-20
3	-30
4	-40
5	-50
6	-60
7	-70
8	-80
9	-90
10	-100

Gases according to ISO 14175

Symbol	Chemical composition (% by mass) a) b)											
	C	Si	Mn	P	S	Ni	Cr	Mo	V	Cu	Al	Ti+Zr
S2	0,07	0,40 - 0,70	0,90 - 1,40	0,025	0,030	-	-	-	-	0,50	0,05 - 0,15	Ti : 0,05 - 0,15 Zr : 0,02 - 0,12
S3	0,06 - 0,15	0,45 - 0,75	0,90 - 1,40	0,025	0,035	-	-	-	-	0,50	-	-
S4	0,06 - 0,15	0,65 - 0,85	1,00 - 1,50	0,025	0,035	-	-	-	-	0,50	-	-
S6	0,06 - 0,15	0,80 - 1,15	1,40 - 1,85	0,025	0,035	-	-	-	-	0,50	-	-
S7	0,07 - 0,15	0,50 - 0,80	1,50 - 2,00	0,025	0,035	-	-	-	-	0,50	-	-
S11	0,02 - 0,15	0,55 - 1,10	1,40 - 1,90	0,030	0,030	-	-	-	-	0,50	-	0,02 - 0,30
S12	0,02 - 0,15	0,55 - 1,00	1,25 - 1,90	0,030	0,030	-	-	-	-	0,50	-	-
S13	0,02 - 0,15	0,55 - 1,10	1,35 - 1,90	0,030	0,030	-	-	-	-	0,50	0,10 - 0,50	0,02 - 0,30
S14	0,02 - 0,15	1,00 - 1,35	1,30 - 1,60	0,030	0,030	-	-	-	-	0,50	-	-
S15	0,02 - 0,15	0,40 - 1,00	1,00 - 1,60	0,030	0,030	-	-	-	-	0,50	-	0,02 - 0,15
S16	0,02 - 0,15	0,40 - 1,00	0,90 - 1,60	0,030	0,030	-	-	-	-	0,50	-	-
S17	0,02 - 0,15	0,20 - 0,55	1,50 - 2,10	0,030	0,030	-	-	-	-	0,50	-	0,02 - 0,30
S18	0,02 - 0,15	0,55 - 1,10	1,60 - 2,40	0,030	0,030	-	-	-	-	0,50	-	0,02 - 0,30
S1M3	0,12	0,30 - 0,70	1,30	0,025	0,025	0,20	-	0,40 - 0,65	-	0,35	-	-
S2M3	0,12	0,30 - 0,70	0,60 - 1,40	0,025	0,025	-	-	0,40 - 0,65	-	0,50	-	-
S2M31	0,12	0,30 - 0,90	0,80 - 1,50	0,025	0,025	-	-	0,40 - 0,65	-	0,50	-	-
S3M3T	0,12	0,40 - 1,00	1,00 - 1,80	0,025	0,025	-	-	0,40 - 0,65	-	0,50	-	Ti: 0,02 - 0,30
S3M1	0,05 - 0,15	0,40 - 1,00	1,40 - 2,10	0,025	0,025	-	-	0,10 - 0,45	-	0,50	-	-
S3M1T	0,12	0,40 - 1,00	1,40 - 2,10	0,025	0,025	-	-	0,10 - 0,45	-	0,50	-	Ti: 0,02 - 0,30
S4M31	0,07 - 0,15	0,50 - 0,80	1,60 - 2,10	0,025	0,025	-	-	0,40 - 0,60	-	0,50	-	-
S4M3T	0,12	0,50 - 0,80	1,60 - 2,10	0,025	0,025	-	-	0,40 - 0,65	-	0,50	-	Ti: 0,02 - 0,30
SN1	0,12	0,20 - 0,50	1,25	0,025	0,025	0,60 - 1,00	-	0,35	-	0,35	-	-
SN2	0,12	0,40 - 0,80	1,25	0,025	0,025	0,80 - 1,10	0,15	0,35	0,05	0,35	-	-
SN3	0,12	0,30 - 0,80	1,20 - 1,60	0,025	0,025	1,50 - 1,90	-	0,35	-	0,35	-	-
SN5	0,12	0,40 - 0,80	1,25	0,025	0,025	2,00 - 2,75	-	-	-	0,35	-	-
SN7	0,12	0,20 - 0,50	1,25	0,025	0,025	3,00 - 3,75	-	0,35	-	0,35	-	-
SN71	0,12	0,40 - 0,80	1,25	0,025	0,025	3,00 - 3,75	-	-	-	0,35	-	-
SN9	0,10	0,50	1,40	0,025	0,025	4,00 - 4,75	-	0,35	-	0,35	-	-
SNCC	0,12	0,60 - 0,90	1,00 - 1,65	0,030	0,030	0,10 - 0,30	0,50 - 0,80	-	-	0,2 - 0,60	-	-
SNCCT	0,12	0,60 - 0,90	1,10 - 1,65	0,030	0,030	0,10 - 0,30	0,50 - 0,80	-	-	0,2 - 0,60	-	Ti: 0,02 - 0,30
SNCCT1	0,12	0,50 - 0,80	1,20 - 1,80	0,030	0,030	0,10 - 0,40	0,50 - 0,80	0,02 - 0,30	-	0,2 - 0,60	-	Ti: 0,02 - 0,30
SNCCT2	0,12	0,50 - 0,90	1,10 - 1,70	0,030	0,030	0,40 - 0,80	0,50 - 0,80	-	-	0,2 - 0,60	-	Ti: 0,02 - 0,30
SN1M2T	0,12	0,60 - 1,00	1,70 - 2,30	0,030	0,030	0,40 - 0,80	-	0,2 - 0,60	-	0,50	-	Ti: 0,02 - 0,30
SN2M1T	0,12	0,30 - 0,80	1,10 - 1,90	0,025	0,025	0,80 - 1,60	-	0,1 - 0,45	-	0,50	-	Ti: 0,02 - 0,30
SN2M2T	0,05 - 0,15	0,30 - 0,90	1,00 - 1,80	0,025	0,025	0,70 - 1,20	-	0,2 - 0,60	-	0,50	-	Ti: 0,02 - 0,30
SN2M3T	0,05 - 0,15	0,30 - 0,90	1,40 - 2,10	0,025	0,025	0,70 - 1,20	-	0,4 - 0,65	-	0,50	-	Ti: 0,02 - 0,30
SN2M4T	0,12	0,50 - 1,00	1,70 - 2,30	0,025	0,025	0,80 - 1,30	-	0,55 - 0,85	-	0,50	-	Ti: 0,02 - 0,30

SZb Any other agreed composition

- a) The electrode shall be analysed for the specific elements for which values are shown in this table. If the presence of other elements is indicated, in the course of this work, the amount of these elements shall be determined to ensure that their total (excluding iron) content does not exceed 0,50 % by mass.
- b) Single values shown in the table are maximum values.
- c) Consumables not listed in this table can be symbolized SZ. The chemical symbol established by the manufacturer may be added in brackets.



## GUIDE TO EN ISO 14343: WIRE ELECTRODES, STRIP ELECTRODES, WIRES AND RODS FOR ARC WELDING OF STAINLESS AND HEAT RESISTING STEELS

14343-A

14343-B

G - gas-shielded metal arc welding  
 W - gas tungsten arc welding  
 P - plasma arc welding  
 S - submerged arc welding  
 B - Submerged arc or electroslag welding with strip electrode  
 L - laser beam welding

**S(B) S – S/B** = Solid wire, strip The second „S“ in „SS“ and the „S“ in „BS“ stand for the alloy system of corrosion-resistant and heat-resistant

G

22 10 3

SS

308 Mo

Alloy designation a) for classification acc. to		Chemical composition, % (m/m) b) c)											
Nominal composition f) ISO 14343-A	Alloy Type ISO 14343-B	C	Si	Mn	P	S	Cr	Ni	Mo	N	Cu	Nb e	Other
<b>Martensitic/ferritic types</b>													
	409	0,08	0,8	0,8	0,03	0,03	10,5 -13,5	0,6	0,5	—	0,75	—	Ti:10xC -1,5
	409Nb	0,12	0,5	0,6	0,03	0,03	10,5 -13,5	0,6	0,75	—	0,75	8 x C -1,0	—
13	(410)	0,15	1,0	1,0	0,03	0,02	12,0 -15	0,3	0,3	—	0,3	—	—
(13)	410	0,12	0,5	0,6	0,03	0,03	11,5 -13,5	0,6	0,75	—	0,75	—	—
13L		0,05	1,0	1,0	0,03	0,02	12,0 -15	0,3	0,3	—	0,3	—	—
13 4	(410NiMo)	0,05	1,0	1,0	0,03	0,02	11,0 -14	3,0 -5,0	0,4 -1,0	—	0,3	—	—
(13 4)	410NiMo	0,06	0,5	0,6	0,03	0,03	11,0 -12,5	4,0 -5,0	0,4 -0,7	—	0,75	—	—
	420	0,25 -0,40	0,5	0,6	0,03	0,03	12,0 -14,0	0,75	0,75	—	0,75	—	—
17	(430)	0,12	1,0	1,0	0,03	0,02	16,0 -19,0	0,3	0,3	—	0,3	—	—
(17)	430	0,10	0,5	0,6	0,03	0,03	15,5 -17,0	0,6	0,75	—	0,3	—	—
	430Nb	0,10	0,5	0,6	0,03	0,03	15,5 -17,0	0,6	0,75	—	0,3	8 x C -1,2	—
18LNb	430LNb	0,02	0,5	0,8	0,03	0,02	17,8 -18,8	0,3	0,3	0,02	0,3	0,05+7(C+N) up -0,5	—
<b>Austenitic types</b>													
	308	0,08	0,65	1,0 -2,5	0,03	0,03	19,5 -22,0	9,0 -11,0	0,75	—	0,75	—	—
	308Si	0,08	0,65 -1,00	1,0 -2,5	0,03	0,03	19,5 -22,0	9,0 -11,0	0,75	—	0,75	—	—
19 9L	(308L)	0,03	0,65	1,0 -2,5	0,03	0,02	19,5 -22,0	9,0 -11,0	0,75	—	0,75	—	—
(19 9L)	308L	0,03	0,65	1,0 -2,5	0,03	0,03	19,5 -22,0	9,0 -11,0	0,75	—	0,75	—	—
19 9LSi	(308LSi)	0,03	0,65 -1,2	1,0 -2,5	0,03	0,02	19,0 -21,0	9,0 -11,0	0,3	—	0,3	—	—
(19 9LSi)	308LSi	0,03	0,65 -1,0	1,0 -2,5	0,03	0,03	19,5 -22,0	9,0 -11,0	0,75	—	0,75	—	—

## GUIDE TO EN ISO 14343: WIRE ELECTRODES, STRIP ELECTRODES, WIRES AND RODS FOR ARC WELDING OF STAINLESS AND HEAT RESISTING STEELS

Alloy designation a) for classification acc. to		Chemical composition, % (m/m) b) c)											
Nominal composition ISO 14343-A	Alloy Type ISO 14343 -B	C	Si	Mn	P	S	Cr	Ni	Mo	N	Cu	Nb e	Other
<b>Austenitic types continued</b>													
19 9Nb	(347)	0,08	0,65	1,0 -2,5	0,03	0,02	19,0 -21,0	9,0 -11,0	0,3	—	0,3	10 x C -1,0	—
(19 9Nb)	347	0,08	0,65	1,0 -2,5	0,03	0,03	19,0 -21,5	9,0 -11,0	0,75	—	0,75	10 x C -1,0	—
19 9NbSi	(347Si)	0,08	0,65 -1,2	1,0 -2,5	0,03	0,02	19,0 -21,0	9,0 -11,0	0,3	—	0,3	10 x C -1,0	—
(19 9NbSi)	347Si	0,08	0,65 -1,0	1,0 -2,5	0,03	0,03	19,0 -21,5	9,0 -11,0	0,75	—	0,75	10 x C -1,0	—
	347L	0,03	0,65	1,0 -2,5	0,03	0,03	19,0 -21,5	9,0 -11,0	0,75	—	0,75	10 x C -1,0	—
	316	0,08	0,65	1,0 -2,5	0,03	0,03	18,0 -20,0	11,0 -14,0	2,0 -3,0	—	0,75	10 x C -1,0	—
	316Si	0,08	0,65 -1,0	1,0 -2,5	0,03	0,03	18,0 -20,0	11,0 -14,0	2,0 -3,0	—	0,75	—	—
19 12 3 L	(316L)	0,03	0,65	1,0 -2,5	0,03	0,02	18,0 -20,0	11,0 -14,0	2,5 -3,0	—	0,3	—	—
(19 12 3 L)	316L	0,03	0,65	1,0 -2,5	0,03	0,03	18,0 -20,0	11,0 -14,0	2,0 -3,0	—	0,75	—	—
19 12 3 LSi	(316LSi)	0,03	0,65 -1,2	1,0 -2,5	0,03	0,02	18,0 -20,0	11,0 -14,0	2,5 -3,0	—	0,3	—	—
(19 12 3 LSi)	316LSi	0,03	0,65 -1,0	1,0 -2,5	0,03	0,03	18,0 -20,0	11,0 -14,0	2,0 -3,0	—	0,75	—	—
	316LCu	0,03	0,65	1,0 -2,5	0,03	0,03	18,0 -20,0	11,0 -14,0	2,0 -3,0	—	1,0 -2,5	—	—
19 12 3 Nb	(318)	0,08	0,65	1,0 -2,5	0,03	0,02	18,0 -20,0	11,0 -14,0	2,5 -3,0	—	0,3	10 x C -1,0	—
(19 12 3 Nb)	318	0,08	0,65	1,0 -2,5	0,03	0,03	18,0 -20,0	11,0 -14,0	2,0 -3,0	—	0,75	10 x C -1,0	—
	318L	0,03	0,65	1,0 -2,5	0,03	0,03	18,0 -20,0	11,0 -14,0	2,0 -3,0	—	0,75	10 x C -1,0	—
19 12 3 NbSi		0,08	0,65 -1,2	1,0 -2,5	0,03	0,02	18,0 -20,0	11,0 -14,0	2,5 -3,0	—	0,3	10 x C -1,0	—
	317	0,08	0,65	1,0 -2,5	0,03	0,03	18,5 -20,5	13,0 -15,0	3,0 -4,0	—	0,75	—	—
(18 15 3 L)	317L	0,03	0,65	1,0 -2,5	0,03	0,03	18,5 -20,5	13,0 -15,0	3,0 -4,0	—	0,75	—	—
	321	0,08	0,65	1,0 -2,5	0,03	0,03	18,5 -20,5	9,0 -10,5	0,75	—	0,75	—	Ti: 9xC -1,0

## GUIDE TO EN ISO 14343: WIRE ELECTRODES, STRIP ELECTRODES, WIRES AND RODS FOR ARC WELDING OF STAINLESS AND HEAT RESISTING STEELS

Alloy designation a) for classification acc. to		Chemical composition, % (m/m) b) c)											
Nominal composition ISO 14343-A	Alloy Type ISO 14343 -B	C	Si	Mn	P	S	Cr	Ni	Mo	N	Cu	Nb e	Sonstige
<b>Ferritic-austenitic types, sometimes referred to as austenitic-ferritic types</b>													
22 9 3 NL	(2209)	0,03	1,0	2,5	0,03	0,02	21,0 -24,0	7,0 -10,0	2,5 -4,0	0,10 -0,20	0,3	—	—
(22 9 3 NL)	2209	0,03	0,90	2,5 -2,0	0,03	0,02	21,5 -23,5	7,5 -9,5	2,5 -3,5	0,08 -0,20	0,75	—	—
25 7 2 L		0,03	1,0	2,5	0,03	0,02	24,0 -27,0	6,0 -8,0	1,5 -2,5	—	0,3	—	—
25 9 3CuNL		0,03	1,0	2,5	0,03	0,02	24,0 -27,0	8,0 -11,0	2,5 -4,0	0,10 -0,20	1,5 -2,5	—	—
25 9 4NL	2594	0,03	1,0	2,5	0,03	0,02	24,0 -27,0	8,0 -10,5	2,5 -4,5	0,20 -0,30	1,5	—	W 1,0
<b>Fully austenitic types f)</b>													
18 15 3L f	(317) f	0,03	1,0	1,0 -4,0	0,03	0,02	17,0 -20,0	13,0 -16,0	2,5 -4,0	—	0,3	—	—
18 16 5NL f	(317) f	0,03	1,0	1,0 -4,0	0,03	0,02	17,0 -20,0	16,0 -19,0	3,5 -5,0	0,10 -0,20	0,3	—	—
19 13 4L f	(317L) f	0,03	1,0	1,0 -5,0	0,03	0,02	17,0 -20,0	12,0 -15,0	3,0 -4,5	—	0,3	—	—
19 13 4NL f		0,03	1,0	1,0 -5,0	0,03	0,02	17,0 -20,0	12,0 -15,0	3,0 -4,5	0,10 -0,20	0,3	—	—
20 25 5CuL f	(385) f	0,03	1,0	1,0 -4,0	0,03	0,02	19,0 -22,0	24,0 -27,0	4,0 -6,0	—	1,0 -2,0	—	—
(20 25 5CuL) f	385 f	0,025	0,50	1,0 -2,5	0,02	0,03	19,5 -21,5	24,0 -26,0	4,2 -5,2	—	1,2 -2,0	—	—
20 25 5CuNL f		0,03	1,0	1,0 -4,0	0,03	0,02	19,0 -22,0	24,0 -27,0	4,0 -6,0	0,10 -0,20	1,0 -2,0	—	—
20 16 3 MnL f		0,03	1,0	5,0 -9,0	0,03	0,02	19,0 -22,0	15,0 -18,0	2,5 -4,5	—	0,3	—	—
20 16 3 MnNL f		0,03	1,0	5,0 -9,0	0,03	0,02	19,0 -22,0	15,0 -18,0	2,5 -4,5	0,10 -0,20	0,3	—	—
25 22 2 N L f		0,03	1,0	3,5 -6,5	0,03	0,02	24,0 -27,0	21,0 -24,0	1,5 -3,0	0,10 -0,20	0,3	—	—
27 31 4 Cu L f	(383) f	0,03	1,0	1,0 -3,0	0,03	0,02	26,0 -29,0	30,0 -33,0	3,0 -4,5	—	0,7 -1,5	—	—
(27 31 4 Cu L) f	383 f	0,025	0,50	1,0 -2,5	0,02	0,03	26,5 -28,5	30,0 -33,0	3,2 -4,2	—	0,7 -1,5	—	—
	320 f	0,07	0,60	2,5	0,03	0,03	19,0 -21,0	32,0 -36,0	2,0 -3,0	—	3,0 -4,0	8 x C -1,0	—
	320LR f	0,025	0,15	1,5 -2,0	0,015	0,02	19,0 -21,0	32,0 -36,0	2,0 -3,0	—	3,0 -4,0	8 x C -0,40	—

## GUIDE TO EN ISO 14343: WIRE ELECTRODES, STRIP ELECTRODES, WIRES AND RODS FOR ARC WELDING OF STAINLESS AND HEAT RESISTING STEELS

Alloy designation a) for classification acc. to		Chemical composition, % (m/m) b) c)											
Nominal composition f) ISO 14343-A	Alloy Type ISO 14343 -B	C	Si	Mn	P	S	Cr	Ni	Mo	N	Cu	Nb e	Other
<b>Special types - often used for joining dissimilar metals</b>													
	307 f	0,04 -0,14	0,65	3,3 -4,8	0,03	0,03	19,5 -22,0	8,0 -10,7	0,5 -1,5	—	0,75	—	—
18 8 Mn f		0,20	1,2	5,0 -8,0	0,03	0,03	17,0 -20,0	7,0 -10,0	0,3	—	0,3	—	—
20 10 3	(308Mo)	0,12	1,0	1,0 -2,5	0,03	0,02	18,0 -21,0	8,0 -12,0	1,5 -3,5	—	0,3	—	—
(20 10 3)	308Mo	0,08	0,65	1,0 -2,5	0,03	0,02	18,0 -21,0	9,0 -12,0	2,0 -3,0	—	0,75	—	—
	308LMo	0,03	0,65	1,0 -2,5	0,03	0,03	18,0 -21,0	9,0 -12,0	2,0 -3,0	—	0,75	—	—
23 12 L	(309L)	0,03	0,65	1,0 -2,5	0,03	0,02	22,0 -25,0	11,0 -14,0	0,3	—	0,3	—	—
(23 12 L)	309L	0,03	0,65	1,0 -2,5	0,03	0,02	23,0 -25,0	12,0 -14,0	0,75	—	0,75	—	—
23 12 LSi	(309LSi)	0,03	0,65 -1,2	1,0 -2,5	0,03	0,02	22,0 -25,0	11,0 -14,0	0,3	—	0,3	—	—
(23 12 LSi)	309LSi	0,03	0,65 -1,0	1,0 -2,5	0,03	0,02	23,0 -25,0	12,0 -14,0	0,75	—	0,75	—	—
23 12 Nb		0,08	1,0	1,0 -2,5	0,03	0,02	22,0 -25,0	11,0 -14,0	0,3	—	0,3	10 x C -1,0	—
	309LNb	0,03	0,65	1,0 -2,5	0,03	0,03	23,0 -25,0	12,0 -14,0	0,75	—	0,75	10 x C -1,0	—
	309Mo	0,12	0,65	1,0 -2,5	0,03	0,03	23,0 -25,0	12,0 -14,0	2,0 -3,0	—	0,75	—	—
23 12 2 L	(309LMo)	0,03	1,0	1,0 -2,5	0,03	0,02	21,0 -25,0	11,0 -15,5	2,0 -3,5	—	0,3	—	—
(23 12 2 L)	309LMo	0,03	0,65	1,0 -2,5	0,03	0,03	23,0 -25,0	12,0 -14,0	2,0 -3,0	—	0,75	—	—
(21 13 3 L)	309LMoD <sup>f</sup>	0,03	0,65	1,0 -2,5	0,03	0,03	19,0 -22,0	12,0 -14,0	2,3 -3,3	—	0,75	—	—
21 13 3 L <sup>f</sup>	(309LMoD)	0,03	0,65	1,0 -2,5	0,03	0,03	19,0 -22,0	12,0 -14,0	2,3 -3,3	—	0,75	—	—
29 9	(312)	0,15	1,0	1,0 -2,5	0,03	0,02	28,0 -32,0	8,0 -12,0	0,3	—	0,3	—	—
(29 9)	312	0,15	0,65	1,0 -2,5	0,03	0,03	28,0 -32,0	8,0 -10,5	0,75	—	0,75	—	—
<b>Heat resisting types</b>													
16 8 2	(16-8-2)	0,10	1,0	1,0 -2,5	0,03	0,02	14,5 -16,5	7,5 -9,5	1,0 -2,5	—	0,3	—	—
(16 8 2)	16-8-2	0,10	0,65	1,0 -2,5	0,03	0,03	14,5 -16,5	7,5 -9,5	1,0 -2,0	—	0,75	—	—
19 9 H	(19-10H)	0,04 -0,08	1,0	1,0 -2,5	0,03	0,02	18,0 -21,0	9,0 -11,0	0,3	—	0,3	—	—

## GUIDE TO EN ISO 14343: WIRE ELECTRODES, STRIP ELECTRODES, WIRES AND RODS FOR ARC WELDING OF STAINLESS AND HEAT RESISTING STEELS

Alloy designation a) for classification acc. to		Chemical composition, % (m/m) b) c)											
Nominal composition f) ISO 14343-A	Alloy Type ISO 14343 -B	C	Si	Mn	P	S	Cr	Ni	Mo	N	Cu	Nb e	Other
<b>Heat resisting types continued</b>													
(19 9 H)	19-10H	0,04 - 0,08	0,65	1,0 -2,0	0,03	0,03	18,5 -20,0	9,0 -11,0	0,25	—	0,75	0,05	Ti 0,05
(19 9 H)	308H	0,04 -0,08	0,65	1,0 -2,5	0,03	0,03	19,5 -22,0	9,0 -11,0	0,50	—	0,75	—	—
19 12 3 H	(316H)	0,04 -0,08	1,0	1,0 -2,5	0,03	0,02	18,0 -20,0	11,0 -14,0	2,0 -3,0	—	0,3	—	—
(19 12 3 H)	316H	0,04 -0,08	0,65	1,0 -2,5	0,03	0,03	18,0 -20,0	11,0 -14,0	2,0 -3,0	—	0,75	—	—
22 12 H	(309)	0,04 -0,15	2,0	1,0 -2,5	0,03	0,02	21,0 -24,0	11,0 -14,0	0,3	—	0,3	—	—
(22 12 H)	309	0,12	0,65	1,0 -2,5	0,03	0,03	23,0 -25,0	12,0 -14,0	0,75	—	0,75	—	—
	309Si	0,12	0,65 -1,0	1,0 -2,5	0,03	0,03	23,0 -25,0	12,0 -14,0	0,75	—	0,75	—	—
25 4		0,15	2,0	1,0 -2,5	0,03	0,02	24,0 -27,0	4,0 -6,0	0,3	—	0,3	—	—
25 20 f	(310) f	0,08 -0,15	2,0	1,0 -2,5	0,03	0,02	24,0 -27,0	18,0 -22,0	0,3	—	0,3	—	—
(25 20) f	310 f	0,08 -0,15	0,65	1,0 -2,5	0,03	0,03	25,0 -28,0	20,0 -22,5	0,75	—	0,75	—	—
	310S f	0,08	0,65	1,0 -2,5	0,03	0,03	25,0 -28,0	20,0 -22,5	0,75	—	0,75	—	—
	310L f	0,03	0,65	1,0 -2,5	0,03	0,03	25,0 -28,0	20,0 -22,5	0,75	—	0,75	—	—
25 20 H f		0,35 -0,45	2,0	1,0 -2,5	0,03	0,02	24,0 -27,0	18,0 -22,0	0,3	—	0,3	—	—
25 20 Mn f		0,08 -0,15	2,0	2,5 -5,0	0,03	0,02	24,0 -27,0	18,0 -22,0	0,3	—	0,3	—	—
18 36 H f	(330)	0,18 -0,25	0,4 -2,0	1,0 -2,5	0,03	0,02	15,0 -19,0	33,0 -37,0	0,3	—	0,3	—	—
(18 36 H) f	330	0,18 -0,25	0,65	1,0 -2,5	0,03	0,03	15,0 -17,0	34,0 -37,0	0,75	—	0,75	—	—
<b>Precipitation hardening type</b>													
	630	0,05	0,75	0,25 -0,75	0,03	0,03	16,0 -16,75	4,5 -5,0	0,75	-	3,25 -4,0	0,15 -0,30	-

a) A designation in parentheses e.g. (308L) or (19/9L) indicates a near match in the other designation system, but not an exact match. The correct designation for a given composition range is the one not in parentheses. A given product may, by having a more restricted chemical composition which fulfils both sets of designation requirements, be assigned both designations independently.

b) Single values shown in the table are maximum values.

c) The results shall be rounded to the same number of significant figures as in the specified value using the rule A in accordance with Annex B of ISO 31-0:1992.

d) Wire electrodes not listed in the table shall be marked in the same way, preceded by the letter Z.

e) Up to 20% of the amount of Nb can be replaced by Ta.

f) The all-weld metal is in most cases fully austenitic and therefore can be susceptible to microfissuring or hot cracking. The occurrence of fissuring/cracking is reduced by increasing the weld metal Mn-level and in recognition of this the Mn-range is extended for a number of grades.

g) This composition is mainly used in low penetration weld cladding, e.g. electro-slag strip cladding.

## GUIDE TO EN ISO 14700: GMAW ELECTRODES FOR MANUAL METAL ARC WELDING OF NICKEL AND NICKEL ALLOY.

Symbol	Type
E	Coated stick electrode
S	solid wire and solid rod
T	cored wire and filler rod
R	cast rod
B	Solid strip
C	sintering rod, filling u. Sintered strip
P	metal powder

T	Fe1
---	-----

Alloy type	Application	Chemical composition % (m/m)													
		C	Cr	Ni	Mn	Mo	W	V	Nb	Fe	Co	Cu	Al	others	Rest
Fe1	p	≤ 0,4	≤ 3,5	≤ 3	≤ 4,5	≤ 1	≤ 1	≤ 1	—	Rest	—	—	—	Si, Ti	Fe
Fe2	p (g) (s)	0,4 - 1,5	≤ 7	≤ 1	≤ 3	≤ 4	≤ 1	≤ 1	—	Rest	≤ 1	≤ 1	—	Si, Ti	Fe
Fe3	s t	0,1-0,5	1-15	≤ 5	≤ 3	≤ 5	≤ 10	≤ 1,5	≤ 3	Rest	≤ 13	—	—	Si, Ti	Fe
Fe4	s t (p)	0,2-1,5	2-10	≤ 4	≤ 3	≤ 10	≤ 20	≤ 4	—	Rest	≤ 5	—	—	Si, Ti	Fe
Fe5	c p s t w	≤ 0,5	≤ 0,1	17-22	≤ 1	3 - 5	—	—	—	Rest	10-15	—	≤ 1	Si, Ti	Fe
Fe6	g p s	≤ 2,5	≤ 10	—	≤ 3	≤ 3	—	—	≤ 10	Rest	—	—	—	Si, Ti	Fe
Fe7	c p t	≤ 0,2	11-30	≤ 6	≤ 3	≤ 2	—	≤ 1	≤ 1	Rest	—	—	—	Si, N	Fe
Fe8	g p t	0,2-2	5-20	—	≤ 3	≤ 5	≤ 2	≤ 2	≤ 10	Rest	—	—	—	Si, Ti	Fe
Fe9	k p (n)	≤ 1,2	≤ 20	≤ 5	9-20	≤ 2	—	≤ 1	—	Rest	—	—	—	Si, Ti	Fe
Fe10	c k p z (n)	≤ 0,25	17-22	7-11	3 - 8	≤ 1,5	—	—	≤ 1,5	Rest	—	—	—	Si	Fe
Fe11	c n z	≤ 0,3	17-32	8-20	≤ 3	≤ 4	—	—	≤ 1,5	Rest	—	—	—	Si, Cu	Fe
Fe12	c n (z)	≤ 0,12	17-27	9-26	≤ 3	≤ 4	—	—	≤ 1,5	Rest	—	—	—	Si	Fe
Fe13	g	≤ 1,5	≤ 7	≤ 4	≤ 3	≤ 4	—	—	—	Rest	—	—	—	Si, B, Ti	Fe
Fe14	g (c)	1,5 - 4,5	25-40	≤ 4	≤ 3	≤ 4	—	—	—	Rest	—	—	—	Si	Fe
Fe15	g	3 - 7	20-40	≤ 4	≤ 3	≤ 2	—	—	≤ 10	Rest	—	—	—	Si, B	Fe
Fe16	g z	4 - 8	10-40	—	≤ 3	≤ 10	≤ 10	≤ 10	≤ 10	Rest	—	—	—	Si, B	Fe
Fe17	c k p v	≤ 0,3	≤ 20	≤ 5	8-20	≤ 2	≤ 0,3	—	—	Rest	10-15	—	—	Si	Fe
Fe20	c g t z	—	—	—	—	—	—	—	—	Rest	—	—	—	Hartstoff b	Fe
Ni1	c p t	≤ 1	15-30	Rest	≤ 1	≤ 6	≤ 2	≤ 1	—	≤ 5	—	—	—	Si, B	Ni
Ni2	c k p t z	≤ 0,1	14-30	Rest	≤ 1,5	10-30	≤ 8	≤ 1	≤ 5	≤ 10	≤ 5	—	—	Si, Ti	Ni
Ni3	c p t	≤ 1	≤ 15	Rest	≤ 1	≤ 6	≤ 2	≤ 1	—	≤ 5	—	—	—	Si, B	Ni
Ni4	c k p t z	≤ 0,1	1-20	Rest	≤ 1,5	≤ 30	≤ 8	≤ 1	≤ 5	≤ 3	≤ 15	—	≤ 3	Si, Ti	Ni
Ni20	c g t z	—	—	Rest	—	—	—	—	—	—	—	—	—	Hartstoff b	Ni
Co1	c k t z	≤ 0,6	20-35	≤ 10	0,1-2	≤ 10	≤ 15	—	≤ 1	≤ 5	—	—	—	Si	Co
Co2	t z (c) (s)	0,6-3	20-35	≤ 4	0,1-2	—	4-10	—	—	≤ 5	—	—	—	Si	Co
Co3	t z (c) (s)	1 - 3	20-35	≤ 4	≤ 2	≤ 1	6-15	—	—	≤ 5	—	—	—	Si	Co
Cr1	g n	1 - 5	Rest	—	≤ 1	—	—	15-30	—	≤ 5	—	—	—	Si, B, Zr	Cr
Cu1	c (n)	—	—	≤ 6	≤ 2	—	—	—	—	≤ 5	—	Rest	7-15	Sn	Cu
Cu2	c (n)	—	—	≤ 6	≤ 15	—	—	—	—	≤ 5	—	Rest	≤ 9	Sn	Cu
Al1	c n	—	—	10-35	≤ 0,5	—	—	—	—	—	—	≤ 6	Rest	Si	Al
Z	—	Any other agreed analysis													

c: non-corrosive

g: scale resistant

k: likely to strain hardening

n: non-magnetizable

p: impact resistant

s: cuttable

t: creep resistant

z: scale resistant

w: temperhardened



v: cavitation resistant

() evt. not applicable for all listed alloys

alloys that are not listed in this table should be characterized similarly by putting the prefix "Z" in front of crushed or spheric fused tungsten carbides or sintered tungsten carbides  
the listed single values are maximum values

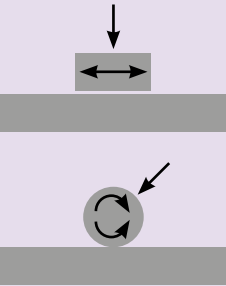
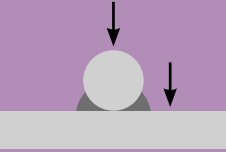
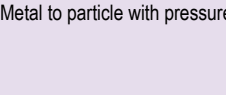
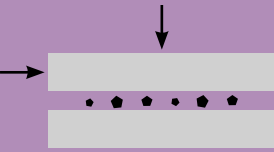
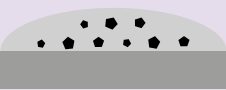

## GUIDE TO EN ISO 14700: GMAW ELECTRODES FOR MANUAL METAL ARC WELDING OF NICKEL AND NICKEL ALLOY.

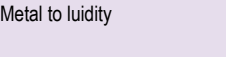
System structure	Type of wear	Application	Symbol EN 14700
Metal to metal wear Particulates and Surface pressure 	Abrasion	Rails, chutes	Fe1, Fe2, Fe3, Cu1
	Impact	Forging hammers	Fe9, F10, Al1, Ni2, Ni4
		Dumper handle, cam shaft	Fe1, Fe2, Fe3
	Rotational Rolling	Rail car wheels, frogs	Fe9, Fe10
		Drive wheels	Fe1, Fe2, Fe3, Fe9
		Train tracks	Fe1, Fe9, Fe10
	Roll-compressional High - temp	Continuous cat roller	Fe7
		Mill roller	Fe3, Fe6, Fe7, Fe8
		Cable rolls	Fe3
	Forging dies	Fe3, Fe4, Fe6, Fe8, Co1, Co2, Co3, Ni2, Ni4	
Impact, friction cold	Knives, shearer edges	Fe4, Fe5, Fe8, Co1, Co2, Co3	
Impact, friction hot	Hot cutting knives	Fe4, Fe3, Co2, Ni2, Ni4	
	Hole punchers	Fe4, Fe3, Co2, Ni2, Ni4	
Metal to metal with particulate 	Impact - abrasion	Stone crusher	Fe6, Fe8, Fe9, Fe14
		Hammer mills	Fe6, Fe8, Fe9
		Hammer rails	Fe6, Fe8, Fe9, Fe13, Fe14, Fe15
		Coal & Ore grinders	Fe6, Fe8
		Grateing & grills	Fe6, Fe8, Fe13, Fe14, Fe15, Fe16
		Coal crushers	Fe13, Fe14, Fe15
		Wear plate	Fe8, Fe13, Fe14, Fe15
		strike plate	Fe13, Fe14, Fe15
Metal to particle with pressure and Impact 	Impact - abrasion	Plough share	Fe15, Fe20, Ni20
		Discharging table, chute	Fe14, Fe15, Fe20, Ni20
		Wearing sheet	Fe14, Fe15, Ni1, Ni2, Ni3, Ni4, Ni20
Metal to metal wear Particulates and Surface pressure 	Abrasion	Extruders	Fe14, Fe15, Fe20, Ni1, Ni3, Ni20, Co2, Co3, Cr1
		Transport screws	Fe14, Fe15, Fe20, Ni1, Ni3, Ni20, Co2, Cr1
		Mixing plates	Fe15, Fe20, Ni20
		Shredder	Fe6, Fe2, Fe8
		Plow blades	Fe2, Fe6, Fe8, Fe20, Ni20
		Mixing paddles, Mixer walls	Fe6, Fe8, Fe14, Fe20, Ni1, Ni3, Ni20
		Grinders & components	Fe6, Fe8, Fe14, Ni1, Ni3
		Mill roller, Compression molds	Fe14
		Metal to particulate with gas 	Particle abrasion T≥500°C
Charging furnace vents	Fe6, Fe3, Fe8, (Fe16)		
Coal & Ore grinders	Fe15, Fe16		
Grateing and grills	Fe7, Co1, Co2		
Coal crushers	Fe10, Fe15, Fe16, Fe20, Ni1, Ni2, Ni3, Ni4, Ni20		
Wear plate	Fe15, Fe16		
Fan, strike plate	Fe14, Fe15, Fe20, Ni1, Ni3, Ni20		
Metal to particulate Pressure and impact 	Fluid wear Fluid erosion	Jet- pipe. wearing sheet	Fe14, Fe15
		Marine dredger sliding, slag	Fe6, Fe8
		Hydraulic pump	Fe6, Fe7, Fe8, Ni1, Ni3
		Mixer	Fe6, Fe7, Fe8
	Corrosion with erosion	Screw propeller	Cu1
		Hydraulic turbine	Fe7, Cu1
Metal to fluidity 	Corrosion, cavitation	Chemical apparatus	Fe7, Fe11, Fe12
		Sealing surface	Fe7, Co1, Co2, Co3

## GUIDE TO EN ISO 14919: THERMAL SPRAYING - WIRES, RODS AND CORDS FOR FLAME AND ARC SPRAYING

5.10

1.6

1

Code No.	Term
1	Tin an tin alloy
2	Zinc and zinc alloys
3	Aluminium and aluminium alloys
4	Copper and copper alloys
5	Iron and iron alloys
6	Nickel and nickel alloys
7	Molybdenum
8	Ceramics

Symbol	Term	Manufacturing process	Structur
1	solid wire / rod	metallurgical manufacturing and forming	homogeneous composition
2	solid wire / rod	powder metallurgical manufacturing and forming	homogeneous composition
3	cored wire (tube shaped wire)	filling up a metal tube and compressed by means of forming	seamless metal shell with powder filling
4	cored wire (tube shaped wire)	forming a metal sheet with powder filling, binder and compressed by means of drawing	metal shell with powder filling
5	CORDS	simultaneous extruding of powder, binder and organic sheath	plastic shell with powder filling
6	oxide ceramic rods	extruding and sintering respectively drying of ceramic material	porous rod consisting of bonded ceramic particles

Wire diameters	
[mm]	Toleranz [mm]
1,6	+ 0; -0,05
1,62	+ 0; -0,05
2,0	+ 0; -0,06
2,3	+ 0; -0,06
2,4	+ 0; -0,06
2,5	+ 0; -0,06
3,0	+ 0; -0,07
3,17	+ 0; -0,07
3,48	+ 0; -0,07
4,76	+ 0; -0,07

Rod diameters	
[mm]	Tolerance [mm]
4,8	+ 0,05; -0,2
6,3	+ 0,05; -0,2

Cord diameters	
[mm]	Tolerance [mm]
3,17	±0,1
4,75	±0,1

Tin and tin alloys				
Code Nr.	Symbol	Alloying elements mass fraction in %	Other elements mass fraction in %	Manufacturing process
1.1	Sn99	Sn ≥ 99,95	total ≤ 0,05 Sb ≤ 0,02 Ag ≤ 0,01 Bi ≤ 0,002 Cu ≤ 0,01 Fe ≤ 0,01 Pb ≤ 0,02 Al+Cd+Zn ≤ 0,002	1
1.2	SnSbCu84	Sb 7 - 8 Cu 3 - 4 Sn Rest	Pb ≤ 0,35 As ≤ 0,1 Bi ≤ 0,08 Fe ≤ 0,1 Al ≤ 0,01 Zn ≤ 0,01 Andere: total ≤ 0,2	1

## GUIDE TO EN ISO 14919: THERMAL SPRAYING - WIRES, RODS AND CORDS FOR FLAME AND ARC SPRAYING

Zinc and zinc alloys				
Code No.	Symbol	Alloying elements mass fraction in %	Other elements mass fraction in %	Manufacturing process
2.1	Zn99,99	Zn ≥ 99,99	total ≤ 0,010 Pb ≤ 0,007 Cd ≤ 0,004 Pb+Cd ≤ 0,011 Sn ≤ 0,001 Fe ≤ 0,005 Cu ≤ 0,002 andere total ≤ 0,12	1
2.2	Zn99	Zn ≥ 99	total ≤ 1,0 Pb ≤ 0,05 Cd ≤ 0,005 Pb+Cd ≤ 0,06 Sn ≤ 0,001 Fe ≤ 0,01 Cu ≤ 0,7 Mo ≤ 0,01 Ti ≤ 0,16 Mg ≤ 0,01 Al ≤ 0,01 andere total ≤ 0,12	1
2.3	ZnAl15	Zn 84 - 86 Al 14 - 16	total ≤ 0,17 Pb ≤ 0,007 Cd ≤ 0,004 Pb+Cd ≤ 0,011 Sn ≤ 0,001 Fe ≤ 0,02 Cu ≤ 0,01 Si ≤ 0,12	1

2.1	1,6	1
-----	-----	---

Code No.	Term
1	Tin an tin alloy
2	Zinc and zinc alloys
3	Aluminium and aluminium alloys
4	Copper and copper alloys
5	Iron and iron alloys
6	Nickel and nickel alloys
7	Molybdenum
8	Ceramics

3.2	1,6	1
-----	-----	---

Aluminium and aluminium alloys				
Code No.	Symbol	Alloying elements mass fraction in %	Other elements mass fraction in %	Manufacturing process
3.2	Al99,5	Al ≥ 99,5	total ≤ 0,3 Si ≤ 0,25 Fe ≤ 0,40 Ti ≤ 0,02 Cu ≤ 0,02 Zn ≤ 0,07 Mn ≤ 0,02 other: particular ≤ 0,03	1
3.3	AlMg5	Mg 4,5 - 5,6 Mn 0,05 - 0,20 Cr 0,05 - 0,20 Ti 0,06 - 0,20 Rest Al	total ≤ 0,9 Si ≤ 0,30 Fe ≤ 0,40 Cu ≤ 0,10 Zn ≤ 0,10 other: particular ≤ 0,15	1
3.4	AlZn5	Zn 4,5 - 5,1 Rest Al	total ≤ 1 Si ≤ 0,30 Fe ≤ 0,40 Cu ≤ 0,05 Sn ≤ 0,20 other: particular ≤ 0,05	1
3.5	AlSi5	Si 4,5 - 6,0 Rest Al	total ≤ 1 Si ≤ 0,30 Fe ≤ 0,80 Cu ≤ 0,30 Mn ≤ 0,05 Mg ≤ 0,05 Zn ≤ 0,10 Sn ≤ 0,20 other: particular ≤ 0,15	1

## GUIDE TO EN ISO 14919:2014: THERMAL SPRAYING - WIRES, RODS AND CORDS FOR FLAME AND ARC SPRAYING

Copper and copper alloys				
Code No.	Symbol	Alloying elements mass fraction in %	Other elements mass fraction in %	Manufacturing process
4.1	Cu99	Cu ≥ 99,9	other ≤ 0,01	1
4.2	CuZn37	Cu 62,0 - 64 rest Zn	Al ≤ 0,03 Fe ≤ 0,1 Mn ≤ 0,1 Ni ≤ 0,3 Pb ≤ 0,1 Sb ≤ 0,01 Sn ≤ 0,1 other: total ≤ 0,5	1
4.3	CuZn39	Cu 56 -62 Sn 0,5-1,5 Si 0,1-0,5	Ni ≤ 1,5 Mn ≤ 1,0 Fe ≤ 0,5 Al ≤ 0,01 Pb ≤ 0,03 other: total ≤ 0,2	1
4.4	CuSn6	Sn 5,0-8,0 rest Cu	Fe ≤ 0,1 Al ≤ 0,01 Zn ≤ 0,1 Pb ≤ 0,02 P 0,01 - 0,4 other: total ≤ 0,4	1
4.6	CuAl8	Al 7,5 - 9,5 rest Cu	Mn ≤ 1,8 Ni ≤ 0,8 Fe ≤ 0,5 Si ≤ 0,2 Zn ≤ 0,2 other: total ≤ 0,5	1
4.7	CuAl10	Al 8,5- 11 Fe 0,5-1,5 rest Cu	Ni+Co ≤ 1,0 Pb ≤ 0,02 Si ≤ 0,1 Mn ≤ 0,03 Zn ≤ 0,02 other: total ≤ 0,3	1

4.1	1,6	1
-----	-----	---

Code No.	Term
1	Tin and tin alloy
2	Zinc and zinc alloys
3	Aluminium and aluminium alloys
4	Copper and copper alloys
5	Iron and iron alloys
6	Nickel and nickel alloys
7	Molybdenum
8	Ceramics

## GUIDE TO EN ISO 14919:2014: THERMAL SPRAYING - WIRES, RODS AND CORDS FOR FLAME AND ARC SPRAYING

5.10

1,6

1

Code No.	Term
1	Tin and tin alloys
2	Zinc and zinc alloys
3	Aluminium and aluminium alloys
4	Copper and copper alloys
5	Iron and iron alloys
6	Nickel and nickel alloys
7	Molybdenum
8	Ceramics

Iron and iron alloys				
Code No.	Symbol	Alloying elements mass fraction in %	Other elements mass fraction in %	Manufacturing process
5.1	10Mn	C 0,04 - 0,12 Mn 0,42 - 0,68 remainder Fe	Si traces Cr ≤ 0,15 Cu ≤ 0,20 Ni ≤ 0,15 P ≤ 0,030 S ≤ 0,030	1
5.3	80MnSi	C 0,8 - 0,85 Si 0,15 - 0,35 Mn 0,50 - 0,70 remainder Fe	P ≤ 0,035 S ≤ 0,035	1
5.6	110MnCrTi5-5	C <0,97 - 1,23 Si 0,12 - 0,38 Mn 1,76 - 2,27 Cr 1,65 - 1,95 remainder Fe	Ti 0,13 - 0,35 P ≤ 0,025 S ≤ 0,025	1
5.7	X45Cr13 a) with Cu plating b) without Cu plating	C 0,3 - 0,50 Si ≤ 1,0 Mn ≤ 1,0 Cr 12 - 14 remainder Fe	P ≤ 0,045 S ≤ 0,030	1
5.8	X20CrMo13-1	C 0,17 - 0,22 Si ≤ 1,0 Mn ≤ 1,0 Cr 12 - 14 Mo 0,9 - 1,3 remainder Fe	Ni ≤ 1,0 P ≤ 0,045 S ≤ 0,030	1
5.9	X6CrAl22-4	C ≤ 0,055 Si ≤ 0,65 Mn ≤ 0,45 Al 3,5 - 5,5 Cr 21 - 23 remainder Fe	P ≤ 0,040 S ≤ 0,025	1
5.10	X6CrNi19-9	C ≤ 0,06 Si ≤ 1,5 Mn ≤ 2,0 Cr 18 - 20 Ni 8,5 - 10,5 remainder Fe	P ≤ 0,030 S ≤ 0,020	1
5.11	(X5CrNi-Mo17-12-2)a	C ≤ 0,08 Si ≤ 1,0 Mn ≤ 2,0 Cr 16,5 - 18,5 Mo 2 - 2,5 Ni 10,5 - 13,5 remainder Fe	P ≤ 0,045 S ≤ 0,030	1,4

## GUIDE TO EN ISO 14919:2014: THERMAL SPRAYING - WIRES, RODS AND CORDS FOR FLAME AND ARC SPRAYING

Iron and iron alloys				
Code No.	Symbol	Alloying elements mass fraction in %	Other elements mass fraction in %	Manufacturing process
5.12	(X12CrNiMn18-8-6)a	C ≤ 0,20 Si ≤ 1,0 Mn 5,5 - 8,0 Cr 17 - 20 Ni 7,5 - 9,5 remainder Fe	P ≤ 0,040 S ≤ 0,025	1,4
5.13	X12CrNi25-20	C ≤ 0,15 Si ≤ 1,5 Mn 1,5 - 3,5 Cr 24 - 27 Ni 19 - 22 remainder Fe	P ≤ 0,025 S ≤ 0,020	1
5.14	X25CrCuB26-3-3	C ≤ 0,3 Cr ≤ 26 Mn ≤ 1 Si ≤ 0,3 Cu ≤ 3 B ≤ 3 remainder Fe	Anderer ≤ 1	3,4
5.15	X25MnAlSi7-5	C ≤ 0,3 Al 4 - 5 Mn 6 - 8 Si ≤ 1,0 remainder Fe	Anderer ≤ 1	3,4
5.16	X39CrMo17-1 a) with Cu plating b) without Cu plating	C 0,33 - 0,45 Si ≤ 1,0 Mn ≤ 1,5 Cr 15,5 - 17,5 Mo 0,80 - 1,3 remainder Fe	P ≤ 0,040 S ≤ 0,015	1

5.10

1,6

1

Code No.	Term
1	Tin and tin alloy
2	Zinc and zinc alloys
3	Aluminium and aluminium alloys
4	Copper and copper alloys
5	Iron and iron alloys
6	Nickel and nickel alloys
7	Molybdenum
8	Ceramics



## GUIDE TO EN ISO 14919:2014: THERMAL SPRAYING - WIRES, RODS AND CORDS FOR FLAME AND ARC SPRAYING

6.1

1,6

1

Code No.	Term
1	Tin and tin alloys
2	Zinc and zinc alloys
3	Aluminium and aluminium alloys
4	Copper and copper alloys
5	Iron and iron alloys
6	Nickel and nickel alloys
7	Molybdenum
8	Ceramics

Nickel and nickel alloys				
Code No.	Symbol	Alloying elements mass fraction in %	Other elements mass fraction in %	Manufacturing process
6.1	NiCu30Mn3Ti (NiCu30)	Ni ≥ 62,0 Cu 27,0 - 35,0 Mn 1,0 - 4,0 Fe 1,0 - 2,5	Al ≤ 0,5 C ≤ 0,15 Si ≤ 1,0 S ≤ 0,02 Ti ≤ 1,0 Nb ≤ 2,5 other: total ≤ 0,5	1
6.2	Ni99	Ni ≥ 99,2	Cu ≤ 0,1 C ≤ 0,25 Fe ≤ 0,4 Mg ≤ 0,15 Mn ≤ 0,3 S ≤ 0,005 Si ≤ 0,2	1
6.3	NiCrFe15-20	Cr 14 - 19 Fe 19 - 25 Ni ≥ 59	Cu ≤ 0,5 C ≤ 0,15 Mn ≤ 2,5 Si ≤ 2,0	1
6.4	NiCr20	Cr 18 - 21 remainder Ni	Cu ≤ 0,5 C ≤ 0,25 Fe ≤ 0,5 Mn ≤ 1,2 Si ≤ 0,5 S ≤ 0,015	1
6.5	NiAl5	Al 4,5 - 5,5 remainder Ni	Mn ≤ 0,3 Ti ≤ 0,4 Si ≤ 0,5 Fe ≤ 0,3 Cu ≤ 0,08 C ≤ 0,005	1, 3, 4, 5
6.6	NiAl20	Al 18 - 22 remainder Ni	Fe ≤ 0,3 Mn ≤ 0,3 Si ≤ 0,5 Cu ≤ 0,1 C ≤ 0,25	3, 4a
6.7	NiAlMo5-5	Al 4,5 - 5,5 Mo ≤ 5 remainder Ni	Andere ≤ 1	3, 4

## GUIDE TO EN ISO 14919:2014: THERMAL SPRAYING - WIRES, RODS AND CORDS FOR FLAME AND ARC SPRAYING

Nickel and nickel alloys				
Code No.	Symbol	Alloying elements mass fraction in %	Other elements mass fraction in %	Manufacturing process
6.8	NiCrAl20-6	Al 6 - 7 Cr 18 - 21 Mo ≤ 5 remainder Ni	other ≤ 1	3, 4
6.9	NiFeAlCr20-14-3	Al 14 - 15 Cr 3 - 5 Fe 17 - 23 remainder Ni	other ≤ 1	3, 4
6.10	NiCrBSi	Cr ≤ 9 Fe ≤ 3 Si ≤ 3,2 B ≤ 1,6 C ≤ 0,3 remainder Ni	other ≤ 1	5
6.11	NiCr22Mo9Nb	Ni ≤ 58,0 Cr 0 18 - 23 Mo 8 - 10 Nb 3,15 - 4,15	C 0,03 - 0,10 Si ≤ 0,5 Mn ≤ 0,5 TiAl ≤ 0,2 Co ≤ 0,1 Cu 1,5 - 3 P ≤ 0,02 S ≤ 0,015 Rest Fe	1,4
6.12	NiCu30Mn	Ni ≤ 63,0 Cu 26,5 - 34,0 Fe 1,00 - 2,5	C ≤ 0,15 Si ≤ 0,50 Mn ≤ 2,00 S ≤ 0,020 Ti ≤ 0,30 Al ≤ 0,5	1

6.10

1,6

1

Code No.	Term
1	Tin and tin alloy
2	Zinc and zinc alloys
3	Aluminium and aluminium alloys
4	Copper and copper alloys
5	Iron and iron alloys
6	Nickel and nickel alloys
7	Molybdenum
8	Ceramics

7.1

1,6

1

Molybdenum				
Code No.	Symbol	Alloying elements mass fraction in %	Other elements mass fraction in %	Manufacturing process
7.1	Mo	ZrO <sub>2</sub> ≥ 92 CaO 5 - 7	Al <sub>2</sub> O <sub>3</sub> ≤ 0,7 SiO <sub>2</sub> ≤ 0,4 Fe <sub>2</sub> O <sub>3</sub> ≤ 0,04 TiO <sub>2</sub> ≤ 0,4 Na <sub>2</sub> O ≤ 0,02 MgO ≤ 0,07	1

## GUIDE TO EN ISO 14919:2014: THERMAL SPRAYING - WIRES, RODS AND CORDS FOR FLAME AND ARC SPRAYING

8.5

1,6

1

Code No.	Term
1	Tin and tin alloys
2	Zinc and zinc alloys
3	Aluminium and aluminium alloys
4	Copper and copper alloys
5	Iron and iron alloys
6	Nickel and nickel alloys
7	Molybdenum
8	Ceramics

Oxide ceramics				
Code Nr.	Symbol	Alloying elements mass fraction in %	Other elements mass fraction in %	Manufacturing process
8.2	70ZrO <sub>2</sub> -30CaO	ZrO <sub>2</sub> ≥ 68 CaO 28 - 31	Al <sub>2</sub> O <sub>3</sub> ≤ 0,7 TiO <sub>2</sub> ≤ 0,4 Na <sub>2</sub> O ≤ 0,02 MgO ≤ 0,07	5
8.3	Cr <sub>2</sub> O <sub>3</sub>	Cr <sub>2</sub> O <sub>3</sub> ≥ 90,0	Al <sub>2</sub> O <sub>3</sub> ≤ 4 CaO ≤ 0,2 SiO <sub>2</sub> ≤ 5 Fe <sub>2</sub> O <sub>3</sub> ≤ 0,3 TiO <sub>2</sub> ≤ 0,3 MgO ≤ 0,1	5, 6
8.4	Al <sub>2</sub> O <sub>3</sub>	Al <sub>2</sub> O <sub>3</sub> ≥ 98	CaO ≤ 0,2 SiO <sub>2</sub> ≤ 0,8 Fe <sub>2</sub> O <sub>3</sub> ≤ 0,09 TiO <sub>2</sub> ≤ 0,03 Na <sub>2</sub> O ≤ 0,06 MgO ≤ 0,3	5, 6
8.5	97Al <sub>2</sub> O <sub>3</sub> -3TiO <sub>2</sub>	Al <sub>2</sub> O <sub>3</sub> ≥ 94 TiO <sub>2</sub> ≥ 3	CaO ≤ 0,2 SiO <sub>2</sub> ≤ 1,0 Fe <sub>2</sub> O <sub>3</sub> ≤ 0,5 Na <sub>2</sub> O ≤ 0,04 MgO ≤ 0,5 Mn <sub>3</sub> O <sub>4</sub> ≤ 0,05	5
8.6	87Al <sub>2</sub> O <sub>3</sub> -13TiO <sub>2</sub>	Al <sub>2</sub> O <sub>3</sub> 85 - 87 TiO <sub>2</sub> 13 - 15	CaO ≤ 0,2 SiO <sub>2</sub> ≤ 0,5 Fe <sub>2</sub> O <sub>3</sub> ≤ 0,3 Na <sub>2</sub> O ≤ 0,2 MgO ≤ 0,3	5, 6
8.7	60Al <sub>2</sub> O <sub>3</sub> -40TiO <sub>2</sub>	Al <sub>2</sub> O <sub>3</sub> 58 - 60 TiO <sub>2</sub> 40 - 42	CaO ≤ 0,2 SiO <sub>2</sub> ≤ 0,5 Fe <sub>2</sub> O <sub>3</sub> ≤ 0,3 Na <sub>2</sub> O ≤ 0,2 MgO ≤ 0,3	5, 6
8.8	70Al <sub>2</sub> O <sub>3</sub> -30SiO <sub>2</sub>	Al <sub>2</sub> O <sub>3</sub> 72 -78 SiO <sub>2</sub> 22 - 28	CaO ≤ 0,2 SiO <sub>2</sub> ≤ 0,5 Fe <sub>2</sub> O <sub>3</sub> ≤ 0,3 Na <sub>2</sub> O ≤ 0,2 MgO ≤ 0,3	5
8.9	70Al <sub>2</sub> O <sub>3</sub> -30MgO	Al <sub>2</sub> O <sub>3</sub> 76 - 82 MgO 18 -24	CaO ≤ 0,2 SiO <sub>2</sub> ≤ 0,5 Fe <sub>2</sub> O <sub>3</sub> ≤ 0,3 Na <sub>2</sub> O ≤ 0,2 MgO ≤ 0,3	5

GUIDE TO EN ISO 16834-A: WIRE ELECTRODES, WIRES, RODS AND DEPOSITS FOR GAS-SHIELDED ARC WELDING OF HIGH STRENGTH STEELS

Symbol	Welding process type
G	gas-shielded metal arc welding
W	gas-tungsten arc welding

Symbol	Min. yield strength a) MPa	Tensile strength MPa	Min. elongation b) %
55	550	640 -820	18
62	620	700 -890	18
69	690	770 -940	17
79	790	880 -1080	16
89	890	940 -1180	15

a) For yield strength the yield, ReL, is used when yielding occurs, otherwise the 0,2 % proof strength, Rp0,2, is used.  
 b) Gauge length is equal to five times the test specimen diameter.

Symbol	Temperature for minimum average impact energy of 47 J		
Z	No requirements	3	-30
A a or Y b	+20	4	-40
0	0	5	-50
2	-20	6	-60

a) Three values must reach average impact energy of 47J, only one of them min 32J.

Gases according to ISO 14175

**G      62      6      M21      Mn4NiMo**

Symbol (ISO 16834-A)	Chemical composition, mass % a) b)										
	C	Si	Mn	P	S	Ni	Cr	Mo	Cu	V	Other elements
Z	Any other defined requirements										
Mn3NiCrMo	0,14	0,60 -0,80	1,30 -1,80	0,015	0,018	0,50 -0,65	0,40 -0,65	0,15 -0,30	0,30	0,03	0,25
Mn3Ni1CrMo	0,12	0,40 -0,70	1,30 -1,80	0,015	0,018	1,20 -1,60	0,20 -0,40	0,20 -0,30	0,35	0,05 -0,13	0,25
Mn3Ni1Mo	0,12	0,40 -0,80	1,30 -1,90	0,015	0,018	0,80 -1,30	0,15	0,25 -0,65	0,30	0,03	0,25
Mn3Ni1,5Mo	0,08	0,20 -0,60	1,30 -1,80	0,015	0,018	1,40 -2,10	0,15	0,25 -0,55	0,30	0,03	0,25
Mn3Ni1Cu	0,12	0,20 -0,60	1,20 -1,80	0,015	0,018	0,80 -1,25	0,15	0,20	0,30 -0,65	0,03	0,25
Mn3Ni1MoCu	0,12	0,20 -0,60	1,20 -1,80	0,015	0,018	0,80 -1,25	0,15	0,20 -0,55	0,30 -0,65	0,03	0,25
Mn3Ni2,5CrMo	0,12	0,40 -0,70	1,30 -1,80	0,015	0,018	2,30 -2,80	0,20 -0,60	0,30 -0,65	0,30	0,03	0,25
Mn4Ni1Mo	0,12	0,50 -0,80	1,60 -2,10	0,015	0,018	0,80 -1,25	0,15	0,20 -0,55	0,30	0,03	0,25
Mn4Ni2Mo	0,12	0,25 -0,60	1,60 -2,10	0,015	0,018	2,00 -2,60	0,15	0,30 -0,65	0,30	0,03	0,25
Mn4Ni1,5CrMo	0,12	0,50 -0,80	1,60 -2,10	0,015	0,018	1,30 -1,90	0,15 -0,40	0,30 -0,65	0,30	0,03	0,25
Mn4Ni2CrMo	0,12	0,60 -0,90	1,60 -2,10	0,015	0,018	1,80 -2,30	0,20 -0,45	0,45 -0,70	0,30	0,03	0,25
Mn4Ni2,5CrMo	0,13	0,50 -0,80	1,60 -2,10	0,015	0,018	2,30 -2,80	0,20 -0,60	0,30 -0,65	0,30	0,03	0,25

a) If not specified: Ti < 0,10%; Zr < 0,10%; Al < 0,12 %. Copper from steel and copper from coating shall not exceed the stated value.

b) Single values shown in the table are maximum values.

## GUIDE TO EN ISO 16834-B: WIRE ELECTRODES, WIRES, RODS AND DEPOSITS FOR GAS-SHIELDED ARC WELDING OF HIGH STRENGTH STEELS

Symbol	Welding process type
G	gas-shielded metal arc welding
W	gas-tungsten arc welding

Symbol	Minimum yield strength MPa	Tensile strength MPa	Minimum elongation b) %
59X	490	590 -790	16
62X	530	620 -820	15
69X	600	690 -890	14
76X	680	760 -960	13
78X	680	780 -980	13
83X	745	830 -1030	12

a) Instead of X: "A" - as-welded condition  
"P" - heat-treatment condition  
"AP" - from both conditions

b) For yield strength the yield, ReL, is used when yielding occurs, otherwise the 0,2 % proof strength, Rp0,2, is used.

c) Gauge length is equal to five times the test specimen diameter.

Symbol	Temperature for minimum average impact energy of or 27 J (°C)	
Z	No requirements	3 -30
A a or Y b	+20	4 -40
0	0	5 -50
2	-20	6 -60

Among five values the highest and the lowest values aren't taken be in account; the average of other three must be 27J, only one them can be min 20J.

Gases according to ISO 14175

**G 69A 6 M21 N2M3T**

Symbol (ISO 16834-B)	Chemical composition in % (m/m) a) b)									
	C	Si	Mn	P	S	Ni	Cr	Mo	Cu	Ti
Z	Any other analyses not defined in this International Norm									
2M3	0,12	0,30 -0,70	0,60 -1,40	0,025	0,025	—	—	0,40 -0,65	0,50	—
3M1	0,05 -0,15	0,40 -1,00	1,40 -2,10	0,025	0,025	—	—	0,10 -0,45	0,50	—
3M1T	0,12	0,40 -1,00	1,40 -2,10	0,025	0,025	—	—	0,10 -0,45	0,50	0,02 -0,30
3M3	0,12	0,60 -0,90	1,10 -1,60	0,025	0,025	—	—	0,40 -0,65	0,50	—
3M31	0,12	0,30 -0,90	1,00 -1,85	0,025	0,025	—	—	0,40 -0,65	0,50	—
3M3T	0,12	0,40 -1,00	1,00 -1,85	0,025	0,025	—	—	0,40 -0,65	0,50	0,02 -0,30

## GUIDE TO EN ISO 16834-B: WIRE ELECTRODES, WIRES, RODS AND DEPOSITS FOR GAS-SHIELDED ARC WELDING OF HIGH STRENGTH STEELS

**G****69A****6****M21****N2M3T**

Table continued

Symbol (ISO 16834-B)	Chemical composition in % (m/m) a) b)									
	C	Si	Mn	P	S	Ni	Cr	Mo	Cu	Ti
4M3	0,12	0,30	1,50 -2,00	0,025	0,025	—	—	0,40 -0,65	0,50	—
4M31	0,05 -0,15	0,50 -0,80	1,60 -2,10	0,025	0,025	—	—	0,40 -0,65	0,40	—
4M3T	0,12	0,50 -0,80	1,60 -2,20	0,025	0,025	—	—	0,40 -0,65	0,50	0,02 -0,30
N1M2T	0,12	0,60 -1,00	1,70 -2,30	0,025	0,025	0,40 -0,80	—	0,20 -0,60	0,50	0,02 -0,30
N1M3	0,12	0,20 -0,80	1,00 -1,80	0,025	0,025	0,30 -0,90	—	0,40 -0,65	0,50	—
N2M1T	0,12	0,30 -0,80	1,10 -1,90	0,025	0,025	0,80 -1,60	—	0,10 -0,45	0,50	0,02 -0,30
N2M2T	0,05 -0,15	0,30 -0,90	1,00 -1,80	0,025	0,025	0,70 -1,20	—	0,20 -0,60	0,50	0,02 -0,30
N2M3	0,12	0,30	1,10 -1,60	0,025	0,025	0,80 -1,20	—	0,40 -0,65	0,50	—
N2M3T	0,05 -0,15	0,30 -0,90	1,40 -2,10	0,025	0,025	0,70 -1,20	—	0,40 -0,65	0,50	0,02 -0,30
N2M4T	0,12	0,50 -1,00	1,70 -2,30	0,025	0,025	0,80 -1,30	—	0,55 -0,85	0,50	0,02 -0,30
N3M2 c	0,08	0,20 -0,55	1,25 -1,80	0,010	0,010	1,40 -2,10	0,30	0,25 -0,55	0,25	0,10
N4M2d	0,09	0,20 -0,55	1,25 -1,80	0,010	0,010	1,40 -2,10	0,30	0,25 -0,55	0,25	0,10
N4M3T	0,12	0,45 -0,90	1,40 -1,90	0,025	0,025	1,50 -2,10	—	0,40 -0,65	0,50	0,01 -0,30
N4M4T	0,12	0,40 -0,90	1,60 -2,10	0,025	0,025	1,90 -2,50	—	0,40 -0,90	0,50	0,02 -0,30
N5M3 e	0,10	0,25 -0,60	1,40 -1,80	0,010	0,010	2,00 -2,80	0,60	0,35 -0,56	0,25	0,10
N5M3T	0,12	0,40 -0,90	1,40 -2,00	0,025	0,025	2,40 -3,10	—	0,40 -0,70	0,50	0,02 -0,30
N7M4T	0,12	0,30 -0,70	1,30 -1,70	0,025	0,025	3,20 -3,80	0,30	0,60 -0,90	0,50	0,02 -0,30
C1M1T	0,02 -0,15	0,50 -0,90	1,10 -1,60	0,025	0,025	—	0,30 -0,60	0,10 -0,45	0,40	0,02 -0,30
N3C1M4T	0,12	0,35 -0,75	1,25 -1,70	0,025	0,025	1,30 -1,80	0,30 -0,60	0,50 -0,75	0,50	0,02 -0,30
N4CM2T	0,12	0,20 -0,60	1,30 -1,80	0,025	0,025	1,50 -2,10	0,20 -0,50	0,30 -0,60	0,50	0,02 -0,30
N4CM21T	0,12	0,20 -0,70	1,10 -1,70	0,025	0,025	1,80 -2,30	0,05 -0,35	0,25 -0,60	0,50	0,02 -0,30
N4CM22T	0,12	0,65 -0,95	1,90 -2,40	0,025	0,025	2,00 -2,30	0,10 -0,30	0,35 -0,55	0,50	0,02 -0,30
N5CM3T	0,12	0,20 -0,70	1,10 -1,70	0,025	0,025	2,40 -2,90	0,05 -0,35	0,35 -0,70	0,50	0,02 -0,30
N5C1M3T	0,12	0,40 -0,90	1,40 -2,00	0,025	0,025	2,40 -3,00	0,40 -0,60	0,40 -0,70	0,50	0,02 -0,30
N6CM2T	0,12	0,30 -0,60	1,50 -1,80	0,025	0,025	2,80 -3,00	0,05 -0,30	0,25 -0,50	0,50	0,02 -0,30
N6C1M4	0,12	0,25	0,90 -1,40	0,025	0,025	2,65 -3,15	0,20 -0,50	0,55 -0,85	0,50	—
N6C2M2T	0,12	0,20 -0,50	1,50 -1,90	0,025	0,025	2,50 -3,10	0,70 -1,00	0,30 -0,60	0,50	0,02 -0,30
N6C2M4	0,12	0,40 -0,60	1,80 -2,00	0,025	0,025	2,80 -3,00	1,00 -1,20	0,50 -0,80	0,50	0,04
N6CM3T	0,12	0,30 -0,70	1,20 -1,50	0,025	0,025	2,70 -3,30	0,10 -0,35	0,40 -0,65	0,50	0,02 -0,30

a) The total of all other non-listed elements (except Fe) shall not exceed 0,50 %.

b) Single values shown in the table are maximum values.

c) V 0,05; Zr 0,10; AL 0,10

d) V 0,04; Zr 0,10; AL 0,10

e) V 0,03; Zr 0,10; AL 0,10



## GUIDE TO EN ISO 17632-A: TUBULAR CORED ELECTRODES FOR GAS SHIELDED AND NON-GAS SHIELDED METAL ARC WELDING OF NON-ALLOY AND FINE GRAIN STEELS

T = Indicates a tubular cored electrode	Symbol	Tensile Strength a) MPa	Yield Strength min. MPa	Elongation b) min. %	Gases according to ISO 14175	Symbol	Hydrogen content, ml/100 g deposited weld metal, max.
	35	440-570	355	22		H5	5
	38	470-600	380	20		H10	10
	42	500-640	420	20		H15	15
	46	530-680	460	20			
	50	560-720	500	18			

**T 46 3 1Ni B M21 1 H5**

Symbol	Impact Energy Charpy-V Temp °C for 47J min.
Z	No requirements
A	20
0	0
2	-20
3	-30
4	-40
5	-50
6	-60
7	-70
8	-80
9	-90
10	-100

PA = Flat position  
 PB = Horizontal-vertical position  
 PC = Transverse position  
 PD = Horizontal overhead position  
 PE = Overhead position  
 PF = Vertical up position  
 PG = Vertical down position

Symbol	Positions a)
1	PA, PB, PC, PD, PE, PF, PG
2	PA, PB, PC, PD, PE, PF
3	PA, PB
4	PA, PB, PG

a) Positions are defined in ISO 6947.

Symbol	Characteristics	Types of weld	Shielding gas
R	Rutile, slow-freezing slag	Single and multiple pass	Required
P	Rutile, fast-freezing slag	Single and multiple pass	Required
B	Basic	Single and multiple pass	Required
M	Metal powder	Single and multiple pass	Required
V	Rutile or basic / fluoride	Single and multiple pass	Not required
W	Basic / fluoride, slow-freezing slag	Single and multiple pass	Not required
Y	Basic/fluoride, fast-freezing slag	Single and multiple pass	Not required
Z	Other types		

Symbol	Chemical composition of all-weld metal, % *		
	Mn	Ni	Mo
No symbol	2.0	–	–
Mo	1.4	–	0.3 - 0.6
MnMo	1.4 - 2.0	–	0.3 - 0.6
1Ni	1.4	0.6 - 1.2	–
1.5Ni	1.6	1.2 - 1.8	–
2Ni	1.4	1.8 - 2.6	–
3Ni	1.4	2.6 - 3.8	–
Mn1Ni	1.4 - 2.0	0.6 - 1.2	–
1NiMo	1.4	0.6 - 1.2	0.3 - 0.6
Z	Any other agreed composition		

\* If not specified Mo<0.2, Ni <0.5, Cr < 0.2, V <0.08, Nb <0.05, Cu < 0.3 and for electrodes without a gas shield Al<2.0, Single values shown in the table are maximum values.

**WELDING KNOW-HOW - STANDARD**

**GUIDE TO EN ISO 17632-B: TUBULAR CORED ELECTRODES FOR GAS SHIELDED AND NON-GAS SHIELDED METAL ARC WELDING OF NON-ALLOY AND FINE GRAIN STEELS**

T = indicates a tubular cored electrode

Symbol	Minimum yield strength a) MPa	Tensile strength MPa	Minimum elongation b) %
43	330	430 -600	20
49	390	490 -670	18
55	460	550 -740	17
57	490	570 -770	17

a) For yield strength the yield, ReL, is used when yielding occurs, otherwise the 0,2 % proof strength, Rp0,2, is used.  
 b) Gauge length is equal to five times the test specimen diameter.

PA = Flat position  
 PB = Horizontal-vertical position  
 PC = Transverse position  
 PD = Horizontal overhead position  
 PE = Overhead position  
 PF = Vertical up position  
 PG = Vertical down position

Symbol	Position a
0	PA, PB
1	PA, PB, PC, PD, PE, PF or PG, or PF + PG

Symbol	Hydrogen content, ml/100 g deposited weld metal, max.
H5	5
H10	10
H15	15

**T 55 4 T5 1 M21 A N2 U H5**

Symbol	Impact Energy Charpy-V Temp °C for 47J min.
Z	No requirements
A	20
0	0
2	-20
3	-30
4	-40
5	-50
6	-60
7	-70
8	-80
9	-90
10	-100

A = Indicates tested as-welded condition

U = Condition will have impact properties of 47 J minimum at the classification test temperature

Table 4B next side

Usability designator	Shielding gas	Operating polarity	Transfer of droplet	Filling type	Welding position	Charekteristics	Type of weld
T1	Required	d.c.(+)	Spray type	Rutile	0 or 1	Low spatter loss, flat to slightly convex bead and high deposition	Single and multiple pass
T2	Required	d.c.(+)	Spray type	Rutile	0	Similar to T1 type, higher manganese and/or silicon for improved performance	Single pass
T3	Not required	d.c.(+)	Globular type	No default	0	Very high welding speeds	Single pass
T4	Not required	d.c.(+)	Globular type	Basic	0	Very high deposition rates, excellent resistance to hot cracking and low penetration	Single and multiple pass
T5	Required	d.c.(+)	Globular type	Lime fluoride	0 or 1	Slightly convex bead, a thin slag without completely converging the weld bead, good impact properties and hot and cold crack resistance compared to T1	Single and multiple pass
T6	Not required	d.c.(+)	Spray type	No default	0	Good impact properties, good penetration into the root of the weld and excellent slag removal even in a deep groove	Single and multiple pass
T7	Not required	d.c.(-)	Small droplet to spray	No default	0 or 1	High deposition rates and excellent resistance to hot cracking	Single and multiple pass
T8	Not required	d.c.(-)	Small droplet to spray	No default	0 or 1	Very good low temperature impact properties	Single and multiple pass
T10	Not required	d.c.(-)	Small droplet	No default	0	High travel speeds on any thickness	Single pass
T11	Not required	d.c.(-)	Spray type	No default	0 or 1	Some electrodes are designed for thin plate only. The manufacturer should be consulted regarding any plate thickness limitations.	Single and multiple pass
T12	Required	d.c.(+)	Spray type	Rutile	0 or 1	Similar to T1 type, improved impact properties and lower manganese requirements	Single and multiple pass
T13	Not required	d.c.(-)	Short arc	No default	0 or 1	Welding for open gap root passes	Single pass
T14	Not required	d.c.(-)	Spray type	No default	0 or 1	High speed welding on coated sheet steels	Single pass
T15	Required	d.c.(+)	Very fine droplet to spray	Metall powder	0 or 1	Core consisting of metal alloys and iron powder, and minimal slag cover	Single and multiple pass
TG	As agreed between purchaser and supplier						

7

## GUIDE TO EN ISO 17632-B: TUBULAR CORED ELECTRODES FOR GAS SHIELDED AND NON-GAS SHIELDED METAL ARC WELDING OF NON-ALLOY AND FINE GRAIN STEELS

<b>T</b>	<b>55</b>	<b>4</b>	<b>T5</b>	<b>1</b>	<b>M21</b>	<b>A</b>	<b>N2</b>	<b>U</b>	<b>H5</b>
----------	-----------	----------	-----------	----------	------------	----------	-----------	----------	-----------

Symbol for chemical composition of all weld metal

Composition designation	Chemical composition a) b) c)										
	C	Mn	Si	P	S	Cr	Ni	Mo	Cu	V	Al
No Symbol	0,18 e	2,00	0,90	0,030	0,030	0,20 f	0,50 f	0,30	-	0,08 f	2,0
K	0,20	1,60	1,00	0,030	0,030	0,20 f	0,50 f	0,30	-	0,08 f	-
2M3	0,12	1,50	0,80	0,030	0,030	-	-	0,40 - 0,65	-	-	1,8
3M2	0,15	1,25 - 2,00	0,80	0,030	0,030	-	-	0,25 - 0,55	-	-	1,8
N1	0,12	1,75	0,80	0,030	0,030	-	0,30 - 1,00	0,35	-	-	1,8
N2	0,12	1,75	0,80	0,030	0,030	-	0,80 - 1,20	0,35	-	-	1,8
N3	0,12	1,75	0,80	0,030	0,030	-	1,00 - 2,00	0,35	-	-	1,8
N5	0,12	1,75	0,80	0,030	0,030	-	1,75 - 2,75	-	-	-	1,8
N7	0,12	1,75	0,80	0,030	0,030	-	2,75 - 3,75	-	-	-	1,8
CC	0,12	0,60 - 1,40	0,20 - 0,08	0,030	0,030	0,30 - 0,45	-	-	0,20 - 0,50	-	1,8
NCC	0,12	0,60 - 1,40	0,20 - 0,08	0,030	0,030	0,45 - 0,75	0,10 - 0,45	-	0,30 - 0,75	-	1,8
NCC1	0,12	0,50 - 1,30	0,20 - 0,08	0,030	0,030	0,45 - 0,75	0,30 - 0,80	-	0,30 - 0,75	-	1,8
N1M2	0,15	2,00	0,80	0,030	0,030	0,20	0,40 - 1,00	0,20 - 0,65	-	0,05	1,8
N2M2	0,15	2,00	0,80	0,030	0,030	0,20	0,80 - 1,20	0,20 - 0,65	-	0,05	1,8
N3M2	0,15	2,00	0,80	0,030	0,030	0,20	1,00 - 2,00	0,20 - 0,65	-	0,05	1,8
G	Any other agreed composition										

a) Single values shown in the table are maximum values.

b) The results shall be rounded to the same number of significant figures as in the specified values using rule A in accordance with Annex B of ISO 31-0 1992.

c) The weld metal shall be analysed for the specific elements for which values as shown in this table.

d) self-shielded electrodes only

e) 0,30% for self-shielded electrodes

f) the analysis of these elements shall be reported only if added intentionally

## WELDING KNOW-HOW - STANDARD

## GUIDE TO EN ISO 17633-A: TUBULAR CORED ELECTRODES AND RODS FOR GAS SHIELDED AND NON-GAS SHIELDED METAL ARC WELDING OF STAINLESS AND HEAT-RESISTING STEELS

T = Indicates a tubular cored electrode

Symbol	Characteristics
B	Basic slag
R	Rutil. slow freezing slag
P	Rutil. fast freezing slag
M	Metal powder
U	Self-shielding
Z	Other types

Gases according to ISO 14175

Symbol	Positions a)
1	PA, PB, PC, PD, PE, PF, PG
2	PA, PB, PC, PD, PE, PF
3	PA, PB
4	PA, PB, PG

a) Positions are defined in ISO 6947.

PA = Flat position  
 PB = Horizontal-vertical position  
 PC = Transverse position  
 PD = Horizontal overhead position  
 PE = Overhead position  
 PF = Vertical up position  
 PG = Vertical down position

<b>T</b>	<b>19123L</b>	<b>R</b>	<b>M21</b>	<b>3</b>
----------	---------------	----------	------------	----------

Alloy designation according to nominal composition	Chemical composition % by mass a) b)											
	C	Mn	Si	Pc	Sc	Cr	Ni	Mo	Nb+Ta	Cu	N	Others
<b>Martensitic / ferritic type</b>												
13	0,12	1,5	1,0	0,03	0,025	11,0 - 14,0	0,3	0,3	-	0,5	-	-
13 Ti	0,10	0,80	1,0	0,03	0,03	10,5 - 13,0	0,3	0,3	-	0,5	-	Ti: 10 x C - 1,1
13 4	0,06	1,5	1,0	0,03	0,025	11,0 - 14,5	3,0 - 5,0	0,4 - 1,0	-	0,5	-	-
17	0,12	1,5	1,0	0,03	0,025	16,0 - 18,0	0,3	0,3	-	0,5	-	-
<b>Austenitic type</b>												
19 9 L	0,04	2,0	1,2	0,03	0,025	18,0 - 21,0	9,0 - 11,0	0,3	-	0,5	-	-
19 9 Nb	0,08	2,0	1,2	0,03	0,025	18,0 - 21,0	9,0 - 11,0	0,3	8 x C - 1,1	0,5	-	-
19 12 3 L	0,04	2,0	1,2	0,03	0,025	17,0 - 20,0	10,0 - 13,0	2,5 - 3,0	-	0,5	-	-
19 12 3 Nb	0,08	2,0	1,2	0,03	0,025	17,0 - 20,0	10,0 - 13,0	2,5 - 3,0	8 x C - 1,1	0,5	-	-
<b>Ferritic - austenitic types ( sometimes referred to as austenitic-ferritic types)</b>												
22 9 3 N L	0,04	2,5	1,2	0,03	0,025	21,0 - 24,0	7,5 - 10,5	2,5 - 4,0	-	0,5	0,08 - 0,20	-
23 7 N L	0,04	0,4 - 1,5	1,0	0,03	0,020	22,5 - 25,5	6,5 - 10,0	0,8	-	0,5	0,10 - 0,20	-
25 9 4 N L	0,04	2,5	1,2	0,03	0,025	24,0 - 27,0	8,0 - 10,5	2,5 - 4,5	-	-	0,20 - 0,30	-
25 9 4 Cu N L	0,04	2,5	1,2	0,03	0,025	24,0 - 27,0	8,0 - 10,5	2,5 - 4,5	-	1,0 - 2,5	0,20 - 0,30	-
<b>Fully austenitic types</b>												
18 16 5 N L	0,03	1,0 - 4,0	1,0	0,03	0,02	17,0 - 20,0	16,0 - 19,0	3,5 - 5,0	-	0,5	0,10 - 0,20	-
19 13 4 N L	0,04	1,0 - 5,0	1,2	0,03	0,025	17,0 - 20,0	12,0 - 15,0	3,0 - 4,5	-	0,5	0,08 - 0,20	-
20 25 5 Cu N L	0,03	1,0 - 4,0	1,0	0,03	0,02	19,0 - 22,0	24,0 - 27,0	4,0 - 6,0	-	1,0 - 2,0	0,10 - 0,20	-

## GUIDE TO EN ISO 17633-A: TUBULAR CORED ELECTRODES AND RODS FOR GAS SHIELDED AND NON-GAS SHIELDED METAL ARC WELDING OF STAINLESS AND HEAT-RESISTING STEELS

<b>T</b>	<b>19123L</b>	<b>R</b>	<b>M21</b>	<b>3</b>
----------	---------------	----------	------------	----------

Alloy designation according to nominal composition	Chemical composition % by mass a) b)											
	C	Mn	Si	Pc	Sc	Cr	Ni	Mo	Nb+Ta <sub>d</sub>	Cu	N	Others
<b>Special types - Often used for dissimilar metal joining</b>												
18 8 Mn	0,20	4,5 - 7,5	1,2	0,035	0,025	17,0 - 20,0	7,0 - 10,0	0,3	-	0,5	-	-
19 9 Mn Mo	0,04 - 0,14	3,0 - 5,0	1,2	0,035	0,025	18,0 - 21,5	9,0 - 11,0	0,5 - 1,5	-	-	-	-
20 10 3	0,08	2,5	1,2	0,035	0,025	19,5 - 22,0	9,0 - 11,0	2,0 - 4,0	-	0,5	-	-
23 12 L	0,04	2,5	1,2	0,030	0,025	22,0 - 25,0	11,0 - 14,0	0,3	-	0,5	-	-
23 12 Nb	0,08	1,0 - 2,5	1,0	0,03	0,02	22,0 - 25,0	11,0 - 14,0	0,3	10 x C - 1,0	0,5	-	-
23 12 2 L	0,04	2,5	1,2	0,030	0,025	22,0 - 25,0	11,0 - 14,0	2,0 - 3,0	-	0,5	-	-
29 9	0,15	2,5	1,2	0,035	0,025	27,0 - 31,0	8,0 - 12,0	0,3	-	0,5	-	-
<b>Heat resisting types</b>												
16 8 2	0,10	1,0	1,0 - 2,5	0,03	0,02	14,5 - 17,5	7,5 - 9,5	1,0 - 2,5	-	0,5	-	Cr + Mo = < 18,5
19 9 H	0,04 - 0,08	1,0	1,0 - 2,5	0,03	0,02	18,0 - 21,0	9,0 - 11,0	0,3	-	0,5	-	-
21 10 N	0,06 - 0,09	0,3 - 1,0	1,0 - 2,0	0,02	0,01	20,5 - 22,5	9,5 - 11,0	0,5	-	0,5	0,10 - 0,20	Ce : < 0,05
22 12 H	0,15	2,5	1,2	0,030	0,025	20,0 - 23,0	10,0 - 13,0	0,3	-	0,5	-	-
25 4	0,15	2,0	1,0 - 2,5	0,03	0,02	24,0 - 27,0	4,0 - 6,0	0,3	-	0,5	-	-
25 20 e	0,06 - 0,20	1,0 - 5,0	1,2	0,030	0,025	23,0 - 27,0	18,0 - 22,0	0,3	-	0,5	-	-
Z f)	Any other agreed composition											
<p>a) Single values shown in the Table are maximum values</p> <p>b) " - " signs in the Table used to indicate that these elements are not required to be analyzed</p> <p>c) The sum of P and S shall not exceed 0,050%, except for 18 16 5 N L, 18 8 Mn and 29 9.</p> <p>d) Up to 20 % of the amount of Nb can be replaced by Ta</p> <p>e) The all-weld metal is in most cases fully austenitic and therefore can be susceptible to microfissuring or hot cracking. The occurrence of fissuring/cracking is reduced by increasing the weld metal manganese level and recognition of this the manganese range is extended for a number of grades</p> <p>f) Consumables for which the chemical composition is not listed in the table be symbolized similarly and prefixed by the letter Z. The chemical composition ranges are not specified and therefore two electrodes with the same Z classification may not be interchangeable</p>												

WELDING KNOW-HOW - STANDARD

GUIDE TO EN ISO 17633-B: TUBULAR CORED ELECTRODES AND RODS FOR GAS SHIELDED AND NON-GAS SHIELDED METAL ARC WELDING OF STAINLESS AND HEAT-RESISTING STEELS

TS = indicates a tubular cored electrode stainless steel

Symbol	Characteristics
F	Flux cored electrodes
M	Metal cored electrodes
R	Cored rods for gas tungsten arc welding

Gases according to ISO 14175

Symbol	Position a
0	PA, PB
1	PA, PB, PC, PD, PE, PF or PG, or PF + PG

PA = Flat position  
 PB = Horizontal-vertical position  
 PC = Transverse position  
 PD = Horizontal overhead position  
 PE = Overhead position  
 PF = Vertical up position  
 PG = Vertical down position

**TS 316L F M21 0**

Symbols and all-weld metal chemical composition requirements of gas shielded flux cored electrodes

Classification ISO	Classification AWS	Chemical composition % by mass a) b)													
		Sh.- gas	C	Mn	Si	Pc	Sc	Cr	Ni	Mo	Nb+Tad	Cu	N	Others	
307	E307TX-X	C1 M12 M21, Z	0,13	3.30-4.75	1,0	0,04	0,03	18.0-20.5	9.0-10.5	0.5-1.5	-	0,75 (0,5 AWS)	-	-	
308	E308TX-X	C1 M12 M21, Z	0,08	0.5-2.5	1,0	0,04	0,03	18.0-21.0	9.0-11.0	0,5	-	0,75 (0,5 AWS)	-	-	
308L	E308LTX-X	C1 M12 M21, Z	0,04	0.5-2.5	1,0	0,04	0,03	18.0-21.0	9.0-11.0	0,5	-	0,75 (0,5 AWS)	-	-	
308H	E308HTX-X	C1 M12 M21, Z	0,04-0,08	0.5-2.5	1,0	0,04	0,03	18.0-21.0	9.0-11.0	0,5	-	0,75 (0,5 AWS)	-	-	
308Mo	E308MoTX-X	C1 M12 M21, Z	0,08	0.5-2.5	1,0	0,04	0,03	18.0-21.0	9.0-11.0	2.0-3.0	-	0,75 (0,5 AWS)	-	-	
308LMo	E308LMoTX-X	C1 M12 M21, Z	0,04	0.5-2.5	1,0	0,04	0,03	18.0-21.0	9.0-12.0	2.0-3.0	-	0,75 (0,5 AWS)	-	-	
309	E309TX-X	C1 M12 M21, Z	0,10	0.5-2.5	1,0	0,04	0,03	0.22.0-25.0	12.0-14.0	0,5	-	0,75 (0,5 AWS)	-	-	
	E309LcbTX-X	C1 M12 M21, Z	0,04	0.5-2.5	1,0	0,04	0,03	0.22.0-25.0	12.0-14.0	0,5	-	0,75 (0,5 AWS)	-	-	
309L	E309LTX-X	C1 M12 M21, Z	0,04	0.5-2.5	1,0	0,04	0,03	0.22.0-25.0	12.0-14.0	0,5	-	0,75 (0,5 AWS)	-	-	
309H		C1 M12 M21, Z	0,04-0,10	0.5-2.5	1,0	0,04	0,03	0.22.0-25.0	12.0-14.0	0,75	-	0,75 (0,5 AWS)	-	-	
309Mo	E309MoTX-X	C1 M12 M21, Z	0,12	0.5-2.5	1,0	0,04	0,03	21.0-25.0	12.0-16.0	2.0-3.0	-	0,75 (0,5 AWS)	-	-	
309LMo	E309LMoTX-X	C1 M12 M21, Z	0,04	0.5-2.5	1,0	0,04	0,03	21.0-25.0	12.0-16.0	2.0-3.0	-	0,75 (0,5 AWS)	-	-	
309LNb		C1 M12 M21, Z	0,04	0.5-2.5	1,0	0,04	0,03	0.22.0-25.0	12.0-14.0	0,75	0,7 - 1,0	0,75 (0,5 AWS)	-	-	
309LNiMo	E309LNiMoTX-X	C1 M12 M21, Z	0,04	0.5-2.5	1,0	0,04	0,03	20.5-23.5	15.0-17.0	2.5-3.5	-	0,75 (0,5 AWS)	-	-	
310	E310TX-X	C1 M12 M21, Z	0,20	1.0-2.5	1,0	0,04	0,03	25.0-28.0	20.0-22.5	0,5	-	0,75 (0,5 AWS)	-	-	
312	E312TX-X	C1 M12 M21, Z	0,15	0.5-2.5	1,0	0,04	0,03	28.0-32.0	8.0-10.5	0,5	-	0,75 (0,5 AWS)	-	-	
316	E316TX-X	C1 M12 M21, Z	0,08	0.5-2.5	1,0	0,04	0,03	17.0-20.0	11.0-14.0	2.0-3.0	-	0,75 (0,5 AWS)	-	-	
316L	E316LTX-X	C1 M12 M21, Z	0,04	0.5-2.5	1,0	0,04	0,03	17.0-20.0	11.0-14.0	2.0-3.0	-	0,75 (0,5 AWS)	-	-	
316H		C1 M12 M21, Z	0,04-0,08	0.5-2.5	1,0	0,04	0,03	17.0-20.0	11.0-14.0	2.0-3.0	-	0,75 (0,5 AWS)	-	-	
316LCu		C1 M12 M21, Z	0,04	0.5-2.5	1,0	0,04	0,03	17.0-20.0	11.0-16.0	1.25-2.75	-	0,75 (0,5 AWS)	-	-	
317		C1 M12 M21, Z	0,08	0.5-2.5	1,0	0,04	0,03	13.0-15.0	12.0-14.0	3.0-4.0	-	0,75 (0,5 AWS)	-	-	
317L	E317LTX-X	C1 M12 M21, Z	0,04	0.5-2.5	1,0	0,04	0,03	18.0-21.0	12.0-14.0	3.0-4.0	-	0,75 (0,5 AWS)	-	-	
318		C1 M12 M21, Z	0,08	0.5-2.5	1,0	0,04	0,03	18.0-20.5	11.0-14.0	2.0-3.0	8 x C min 1,0 max	0,75 (0,5 AWS)	-	-	
347		C1 M12 M21, Z	0,08	0.5-2.5	1,0	0,04	0,03	18.0-21.0	9.0-11.0	0,75	8 x C min 1,0 max	0,75 (0,5 AWS)	-	-	
347L		C1 M12 M21, Z	0,04	0.5-2.5	1,0	0,04	0,03	18.0-21.0	9.0-11.0	0,75	8 x C min 1,0 max	0,75 (0,5 AWS)	-	-	
347H		C1 M12 M21, Z	0,04-0,08	0.5-2.5	1,0	0,04	0,03	18.0-21.0	9.0-11.0	0,75	8 x C min 1,0 max	0,75 (0,5 AWS)	-	-	
409	E409TX-X	C1 M12 M21, Z	0,10	0,80	1,0	0,04	0,03	10.5-13.5	0,6	0,75	-	0,75 (0,5 AWS)	-	Ti: 10xC 1,5 max	
409Nb		C1 M12 M21, Z	0,10	1,2	1,0	0,04	0,03	10.5-13.5	0,6	0,75	8 x C min 1,5 max	0,75 (0,5 AWS)	-	-	
410	E410TX-X	C1 M12 M21, Z	0,12	1,2	1,0	0,04	0,03	11.5-13.5	0,6	0,75	-	0,75 (0,5 AWS)	-	-	
410NiMo	E410NiMoTX-X	C1 M12 M21, Z	0,06	1,0	1,0	0,04	0,03	11.5-12.5	4.0-5.0	0.40-0.7	-	0,75 (0,5 AWS)	-	-	
	E410NiTiTX-X	C1 M12 M21, Z	0,04	0,7	0,5	0,03	0,03	11.0-12.0 3	3.6-4.5	0,5	-	0,75 (0,5 AWS)	-	-	
430	E430TX-X	C1 M12 M21, Z	0,10	1,0	1,0	0,04	0,03	15.0-18.0	0,6	0,75	-	0,75 (0,5 AWS)	-	-	
430Nb		C1 M12 M21, Z	0,10	1,2	1,0	0,04	0,03	15.0-18.0	0,6	0,75	0.5-1.5	0,75 (0,5 AWS)	-	-	
16-8-2		C1 M12 M21, Z	0,10	0.5-2.5	1,0	0,04	0,03	14.5-17.5	7.5-9.5	1.0-2.0	-	0,75 (0,5 AWS)	-	Cr+Mo = 18,5 max	
	E502TX-X	C1 M12 M21, Z	0,10	1,2	1,0	0,04	0,03	4.0-6.0	0,40	0.45-0.65	-	0,75 (0,5 AWS)	-	-	
	E505TX-X	C1 M12 M21, Z	0,10	12	1,0	0,04	0,03	8.0-10.5	0,40	0.85-1.20	-	0,75 (0,5 AWS)	-	-	
2209	E2209TO-X	C1 M12 M21, Z	0,04	0.5-2.0	1,0	0,04	0,03	21.0-24.0	7.5-10.0	2.5-4.0	-	0,75 (0,5 AWS)	0.08-0.20	-	
2553	E2553TO-X	C1 M12 M21, Z	0,04	0.5-1.5	1,0	0,04	0,03	24.0-27.0	8.5-10.5	2.9-3.9	-	0,75 (0,5 AWS)	0.10-0.25	-	
2594		C1 M12 M21, Z	0,04	0.5-2.5	1,0	0,04	0,03	24.0-27.0	8.0-10.5	2.5-4.5	-	0,75 (0,5 AWS)	0.20-0.30	W:1.0	
		C1 M12 M21, Z	Any other agreed composition												

a) "-" signs in the Table are used to indicate that these element are not required to be analyzed

b) Single values shown in Table are maximum values.

c) Consumables for which the chemical composition is not listed in the table shall be symbolized similarly and prefixed by letter Z. The chemical composition ranges are not specified and therefore two electrodes with same Z classification may not be interchangeable



## GUIDE TO EN ISO 17633-B: TUBULAR CORED ELECTRODES AND RODS FOR GAS SHIELDED AND NON-GAS SHIELDED METAL ARC WELDING OF STAINLESS AND HEAT-RESISTING STEELS

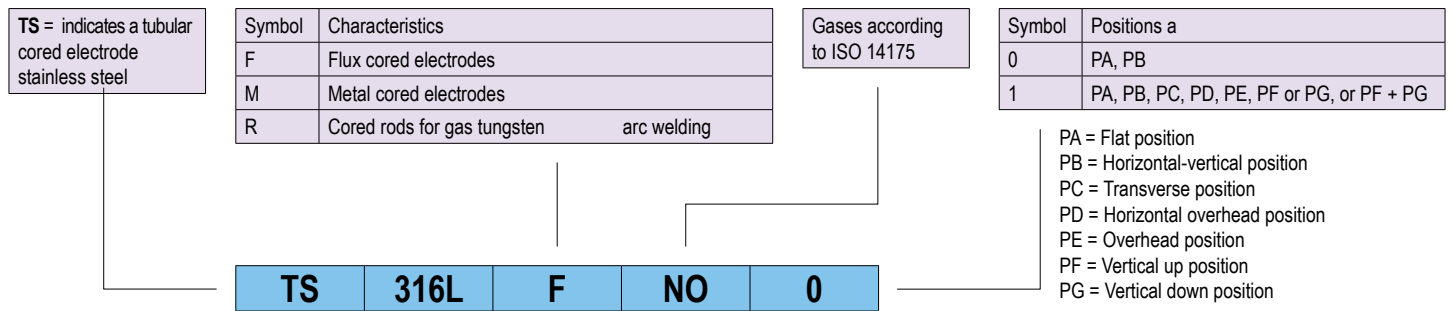

Symbols and all-weld metal chemical composition requirements of non-gas shielded flux cored electrodes

Classification ISO	Classification AWS	Chemical composition % by mass a) b)													
		Sh.- gas	C	Mn	Si	Pc	Sc	Cr	Ni	Mo	Nb+Tad	Cu	N	Others	
307	E307T0-3	NO	0,13	3.30-4.75	1,0	0,04	0,03	19.5-22.0	9.0-10.5	0.5-1.5	-	0,75 (0,5)	-	-	
308	E308T0-3	NO	0,08	0.5-2.5	1,0	0,04	0,03	19.5-22.0	9.0-11.0	0,75(0,5)	-	0,75 (0,5)	-	-	
308L	E308LT0-3	NO	0,04(0,03)	0.5-2.5	1,0	0,04	0,03	19.5-22.0	9.0-12.0 (11,0)	0,75(0,5)	-	0,75 (0,5)	-	-	
308H	E308HT0-3	NO	0,04-0,08	0.5-2.5	1,0	0,04	0,03	19.5-22.0	9.0-11.0	0,75(0,5)	-	0,75 (0,5)	-	-	
308Mo	E308MoT0-3	NO	0,08	0.5-2.5	1,0	0,04	0,03	18.0-21.0	9.0-11.0	2.0-3.0	-	0,75 (0,5)	-	-	
308LMo	E308LMoT0-3	NO	0,04(0,03)	0.5-2.5	1,0	0,04	0,03	18.0-21.0	9.0-12.0	2.0-3.0	-	0,75 (0,5)	-	-	
308HMo	E308HMoT0-3	NO	0.07-0.12	1.25-2.25	0.25-0.80	0,04	0,03	19.0-21.5	9.0-10.7	1.8-2.4	-	0,75 (0,5)	-	-	
309	E309T0-3	NO	0,10	0.5-2.5	1,0	0,04	0,03	22.0-25.0	12.0-14.0	0,75(0,5)	-	0,75 (0,5)	-	-	
309L	E309LT0-3	NO	0,04(0,03)	0.5-2.5	1,0	0,04	0,03	22.0-25.0	12.0-14.0	0,75(0,5)	-	0,75 (0,5)	-	-	
309Mo	E309MoT0-3	NO	0,12	0.5-2.5	1,0	0,04	0,03	21.0-25.0	12.0-16.0	2.0-3.0	-	0,75 (0,5)	-	-	
309LMo	E309LMoT0-3	NO	0,04	0.5-2.5	1,0	0,04	0,03	21.0-25.0	12.0-16.0	2.0-3.0	-	0,75 (0,5)	-	-	
309LNb	E309LCbT0-3	NO	0,04(0,03)	0.5-2.5	1,0	0,04	0,03	23.0-25.5	12.0-14.0	0,75(0,5)	0,7 - 1,0	0,75 (0,5)	-	-	
310	E310T0-3	NO	0,20	1.0-2.5	1,0	0,04	0,03	25.0-28.0	20.0-22.5	0,75(0,5)	-	0,75 (0,5)	-	-	
312	E312T0-3	NO	0,15	0.5-2.5	1,0	0,04	0,03	28.0-32.0	8.0-10.5	0,75(0,5)	-	0,75 (0,5)	-	-	
316	E316T0-3	NO	0,08	0.5-2.5	1,0	0,04	0,03	18.0-20,5	11.0-14.0	2.0-3.0	-	0,75 (0,5)	-	-	
316L	E316LT0-3	NO	0,04(0,03)	0.5-2.5	1,0	0,04	0,03	18.0-20,5	11.0-14.0	2.0-3.0	-	0,75 (0,5)	-	-	
	E316LKT0-3	NO	0,04	0.5-2.5	1,0	0,04	0,03	17.0-20.0	11.0-14.0	2.0-3.0	-	0,75 (0,5)	-	-	
316H		NO	0,04-0,08	0.5-2.5	1,0	0,04	0,03	18.0-20,5	11.0-14.0	2.0-3.0	-	0,75 (0,5)	-	-	
316LCu		NO	0,04	0.5-2.5	1,0	0,04	0,03	17.0-20.0	11.0-16.0	1.25-2.75	-	0,75 (0,5)	-	-	
317		NO	0,08	0.5-2.5	1,0	0,04	0,03	13.0-15.0	13.0-15.0	3.0-4.0	-	0,75 (0,5)	-	-	
317L	E317LT0-3	NO	0,04(0,03)	0.5-2.5	1,0	0,04	0,03	18.0-21.0	13.0-15.0	3.0-4.0	-	0,75 (0,5)	-	-	
318		NO	0,08	0.5-2.5	1,0	0,04	0,03	18.0-20,5	11.0-14.0	2.0-3.0	8 x C min 1,0 max	0,75 (0,5)	-	-	
347	E347T0-3	NO	0,08	0.5-2.5	1,0	0,04	0,03	18.0-21.0	9.0-11.0	0,75(0,5)	8 x C min 1,0 max	0,75 (0,5)	-	-	
347L		NO	0,04	0.5-2.5	1,0	0,04	0,03	18.0-21.0	9.0-11.0	0,75	8 x C min 1,0 max	0,75 (0,5)	-	-	
347H		NO	0,04-0,08	0.5-2.5	1,0	0,04	0,03	18.0-21.0	9.0-11.0	0,75	8 x C min 1,0 max	0,75 (0,5)	-	-	
409	E409T0-3	NO	0,10	0,80	1,0	0,04	0,03	10.5-13.5	0,6	0,75(0,5)	-	0,75 (0,5)	-	Ti: 10xC 1,5 max	
409Nb		NO	0,10	1,2	1,0	0,04	0,03	10.5-13.5	0,6	0,75	8 x C min 1,5 max	0,75 (0,5)	-	-	
410	E410T0-3	NO	0,12	1,0	1,0	0,04	0,03	11.5-13.5	0,6	0,75(0,5)	-	0,75 (0,5)	-	-	
410NiMo	E410NiMoT0-3	NO	0,06	1,0	1,0	0,04	0,03	11.5-12.5	4.0-5.0	0.40-0.7	-	0,75 (0,5)	-	-	
	E410NiTiT0-3	NO	0,04	0,7	0,5	0,03	0,03	11.0-12.0 3	3.6-4.5	0,5	-	0,75 (0,5)	-	-	
430	E430T0-3	NO	0,10	1,0	1,0	0,04	0,03	15.0-18.0	0,6	0,75(0,5)	-	0,75 (0,5)	-	-	
430Nb		NO	0,10	1,2	1,0	0,04	0,03	15.0-18.0	0,6	0,75	0.5-1.5	0,75 (0,5)	-	-	
16-8-2		NO	0,10	0.5-2.5	1,0	0,04	0,03	14.5-17.5	7.5-9.5	1.0-2.0	-	0,75 (0,5)	-	Cr+Mo=18,5 max	
2209		NO	0,04	0.5-2.0	1,0	0,04	0,03	21.0-24.0	7.5-10.0	2.5-4.0	-	0,75 (0,5)	0,08-0,20	-	
2553		NO	0,04	0.5-1.5	1,0	0,04	0,03	24.0-27.0	8.5-10.5	2.9-3.9	-	0,75 (0,5)	0,10-0,25	-	
2594		NO	0,04	0.5-2.5	1,0	0,04	0,03	24.0-27.0	8.0-10.5	2.5-4.5	-	0,75 (0,5)	0,20-0,30	W:1.0	
		NO	Any other agreed composition												

a) "-" signs in the Table are used to indicate that these element are not required to be analyzed

b) Single values shown in Table are maximum values.

c) Consumables for which the chemical composition is not listed in the table shall be symbolized similarly and prefixed by letter Z The chemical composition ranges are not specified and therefore two electrodes with same Z classification may not be interchangeable (XX) = AWS Percent

WELDING KNOW-HOW - STANDARD

GUIDE TO EN ISO 17633-B: TUBULAR CORED ELECTRODES AND RODS FOR GAS SHIELDED AND NON-GAS SHIELDED METAL ARC WELDING OF STAINLESS AND HEAT-RESISTING STEELS

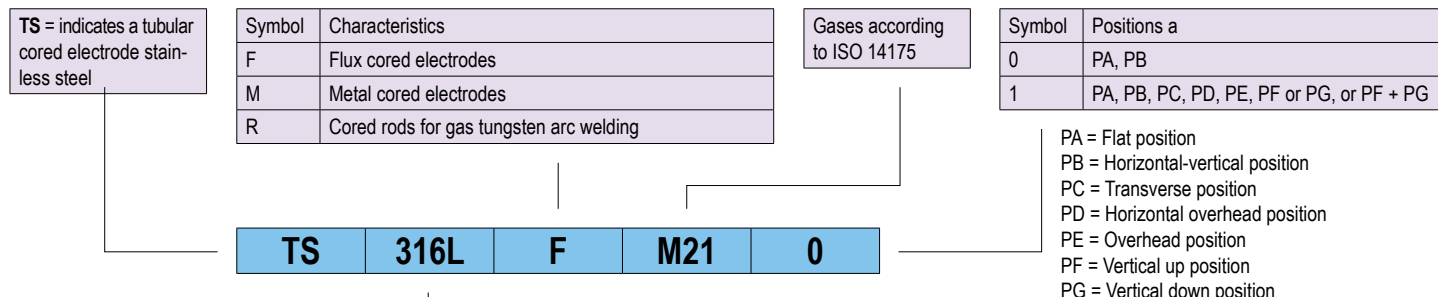

Symbols and all-weld metal chemical composition requirements of gas shielded metal cored electrodes

Classification ISO	Chemical composition % by mass a) b)												
	Sh.- gas	C	Mn	Si	Pc	Sc	Cr	Ni	Mo	Nb+Ta d	Cu	N	Others
308L	M12,M13,M21,I1,Z	0,04	1,0-2,5	1,0	0,03	0,03	19,0-22,0	9,0-11,0	0,75	-	0,75	-	-
308LMo	M12,M13,M21,I1,Z	0,08	1,0-2,5	0,30-0,65	0,03	0,03	18,0-21,0	9,0-12,0	2,0-3,0	-	0,75	-	-
309L	M12,M13,M21,I1,Z	0,04	1,0-2,5	1,0	0,03	0,03	23,0-25,0	12,0-14,0	0,75	-	0,75	-	-
309LMo	M12,M13,M21,I1,Z	0,04	1,0-2,5	1,0	0,03	0,03	23,0-25,0	12,0-14,0	2,0-3,0	-	0,75	-	-
316L	M12,M13,M21,I1,Z	0,03	1,0-2,5	0,30-0,65	0,03	0,03	18,0-20,0	11,0-14,0	2,0-3,0	-	0,75	-	-
347	M12,M13,M21,I1,Z	0,08	1,0-2,5	0,30-0,65	0,04	0,03	19,0-21,5	9,0-11,0	0,75	10xC 1,0max	0,75	-	-
409	M12,M13,M21,I1,Z	0,08	0,8	0,8	0,03	0,03	10,5-13,5	0,6	0,75	-	0,75	-	Ti:10xC 1,5max
409Nb	M12,M13,M21,I1,Z	0,12	1,2	1,0	0,03	0,03	10,5-13,5	0,6	0,75	8xC 1,5max	0,75	-	-
410	M12,M13,M21,I1,Z	0,12	0,6	0,5	0,03	0,03	11,5-13,5	0,6	0,75	-	0,75	-	-
410NiMo	M12,M13,M21,I1,Z	0,06	1,0	1,0	0,04	0,03	11,0-12,5	4,0-5,0	0,4-0,7	-	0,75	-	-
430	M12,M13,M21,I1,Z	0,10	0,6	0,5	0,03	0,03	15,5-18,0	0,6	0,75	-	0,75	-	-
430Nb	M12,M13,M21,I1,Z	0,10	1,2	1,0	0,04	0,03	15,0-18,0	0,6	0,75	0,5-1,5	0,75	-	-
Z	M12,M13,M21,I1,Z	Any other agreed composition											

- a) "-" signs in the Table are used to indicate that these element are not required to be analyzed
- b) Single values shown in Table are maximum values.
- c) Consumables for which the chemical composition is not listed in the table shall be symbolised similary and prefixed by letter Z The chemical composition ranges are not specified and therefore two electrodes with same Z classification may not be interchangeable

Symbols and all-weld metal chemical composition requirements of cored rods for tungsten arc welding

Classification ISO	Classification AWS	Chemical composition % by mass a) b)												
		Sh.- gas	C	Mn	Si	Pc	Sc	Cr	Ni	Mo	Nb+Tad	Cu	N	Others
308L	R308LT1-5	Argon I1,Z	0,03	0,5-2,5	1,2	0,04	0,03	18,0-21,0	9,0-11,0	0,5	-	0,5	-	-
309L	R309LT1-5	Argon I1,Z	0,03	0,5-2,5	1,2	0,04	0,03	22,0-25,0	12,0-14,0	0,5	-	0,5	-	-
316L	R316LT1-5	Argon I1,Z	0,03	0,5-2,5	1,2	0,04	0,03	17,0-20,0	11,0-14,0	2,0-3,0	-	0,5	-	-
347L	R347T1-5	Argon I1,Z	0,08	0,5-2,5	1,2	0,04	0,03	18,0-21,0	9,0-11,0	0,5	8xC 1,0max	0,5	-	-
Z		Argon I1,Z	Any other agreed composition											

- a) "-" signs in the Table are used to indicate that these element are not required to be analyzed
- b) Single values shown in Table are maximum values.
- c) Consumables for which the chemical composition is not listed in the table shall be symbolised similary and prefixed by letter Z The chemical composition ranges are not specified and therefore two electrodes with same Z classification may not be interchangeable

## GUIDE TO EN ISO 17633-A/B: TUBULAR CORED ELECTRODES AND RODS FOR GAS SHIELDED AND NON-GAS SHIELDED METAL ARC WELDING OF STAINLESS AND HEAT-RESISTING STEELS

## Supplementary information

ISO Classification A	ISO Classification B	AWS Classification	Proof strength Rp0,2		Tensile Strength Rm		Elongation Iso A/B (AWS) %	Postweld Heat Treatment	<b>Note:</b> a) Gauge length is equal to five times test specimen diameter b) The weld test assembly (or blank from it, with the tensile test specimen is to be machined) shall be heated to a temperature between 730°C and 760°C, held for 1h, then furnace to 315°C, then cooled in air. c) The weld test assembly (or blank from it, with the tensile test specimen is to be machined) shall be heated to a temperature between 590°C and 620°C, held for 1h, then cooled in air. d) The weld test assembly (or blank from it, with the tensile test specimen is to be machined) shall be heated to a temperature between 760°C and 790°C, held for 2h, then furnace to 600°C, then cooled in air. e) The weld test assembly (or blank from it, from which the tensile test specimen is to be machined) shall be heated to a temperature between 1550 and 1600°F (840 and 870°C) held for 2 hours, then furnace cooled to 1100°F (593°C) at a rate not to exceed 100°F (55°C) per hour, then cooled in air to room temperature <b>Elongation (AWS %)</b>
			ksi	MPa	ksi	MPa			
	307	E307TX-X			75	590	25 (30)	None	
	308	E308TX-X			80	550	25 (35)		
19 9 L	308L	E308LTX-X	46	320	75	(Iso A 510) 520	30 / 25 (35)		
19 9 H	308H	E308HTX-X	51	350	75	550	30 / 25 (35)		
20 10 3	308Mo	E308MoTX-X	58	400	80	(Iso A 620) 550	20 / 25 (35)		
	308LMo	E308LMoTX-X			75	520	25 (35)		
	308HMo				75	550	25		
21 10 N			51	350	75	550	25		
23 7 N L			65	450	83	570	20		
	309	E309TX-X			80	550	25 (30)		
23 12 Nb	309Nb		51	350	75	550	25		
	309LNb	E309LCbTX-X			75	520	25 (30)		
23 12 L	309L	E309LTX-X	46	320	70	(Iso A 510) 520	25 (30)		
22 12 H	309H		51	350	80	550	25		
	309Mo	E309MoTX-X			80	550	15 (25)		
23 12 2 L	309LMo	E309LMoTX-X	51	350	75	(Iso A 550) 520	25 (30)		
	309LNiMo	E309LNiMoTX-X			75	520	25		
25 20	310	E310TX-X	51	350	80	550	25 (30)		
25 4			65	450	94	650	15		
29 9	312	E312TX-X	65	450	95	(Iso A 650) 660	15 (22)		
	316	E316TX-X			75	520	25 (30)		
19 12 3 L	316L	E316LTX-X	46	320	70	(Iso A 510) 485	25 (30)		
	316H				75	520	25		
	316LCu				70	485	25		
19 13 4 N L			51	350	75	550	25		
	317				80	550	20		
	317L	E317LTX-X			75	520	20		
19 12 3 Nb	318		51	350	75	(Iso A 550) 520	25 / 20		
19 9 Nb	347	E347TX-X	51	350	75	(Iso A 550) 520	25 (30)		
	347L				75	520	25		
19 9 Nb	347 H				80	550	25		
13 Ti	409	E409TX-X	36	250	65	450	15		
	409Nb				65	450	15	b	
13	410	E410TX-X	36	250	75	(Iso A 450) 520	20	b	
13 4	410NiMo	E410NiMoTX-X	73	500	110	(Iso A 750) 760	10 (15)	c	
		E410NiTiTX-X			110	760	15	c	
17	430	E430TX-X	44	300	65	450	15 (20)	d	
	430Nb				65	450	13	d	
		E502TX-X			60	415	20	e	
		E505TX-X			60	415	20	e	
		E308HMoT0-3			80	550	30	None	
		E316LKT0-3			70	485	30	None	
16-8-2	16-8-2		46	320	75	(IsoA 510) 520	25	None	
18 16 5 N L			44	300	70	480	25		
18 8 Mn			51	350	73	500	25		
18 9 Mn Mo			51	350	73	500	25		
22 9 3 N L	2209	E2209TX-X	65	45	100	(IsoA 550) 690	20 / 15 (20)		
20 25 5 Cu N L			46	320	74	510	25		
25 9 4 Cu N L	2553	E2553TX-X			110	760	13 (15)		
25 9 4 N L	2594		80	550	110	(Iso A 620) 760	18 / 13		
25 9 4 Cu N L	Z	EXXXTX-G	Not Specified					None	
		R308LT1-5			75	520	35		
		R309LT1-5			75	520	30		
		R316LT1-5			70	485	30		
		R347T1-5			75	520	30		

GUIDE TO EN ISO 17634-A: TUBULAR CORED ELECTRODES FOR GAS SHIELDED METAL ARC WELDING OF CREEP-RESISTING STEELS

T = Indicates a tubular cored electrode

Symbol	Characteristics
B	Basic slag
R	Rutil. slow freezing slag
P	Rutil. fast freezing slag
M	Metal powder
U	Self-shielding
Z	Other types

Gases acc. to ISO 14175

Symbol	Positions a)
1	PA, PB, PC, PD, PE, PF, PG
2	PA, PB, PC, PD, PE, PF
3	PA, PB
4	PA, PB, PG

a) Position sind definiert in ISO 6947.

PA = Flat position  
 PB = Horizontal-vertical position  
 PC = Transverse position  
 PD = Horizontal overhead position  
 PE = Overhead position  
 PF = Vertical up position  
 PG = Vertical down position

Symbol	Hydrogen content, ml/100 g deposited weld metal, max.
H5	5
H10	10
H15	15

**T CrMo1 B M21 4 H5**

Chemical composition symbols for classification according to		Chemical composition, % b) c)								
ISO 3580-A d	Tensile strength and chemical composition ISO 3580-Be	C	Mn	Si	P	S	Ni	Cr	Mo	V
Mo	(2M3)	0,07 -0,12	0,60 -1,30	0,80	0,020	0,020	0,3	0,20	0,40 -0,65	0,03
(Mo)	2M3	0,12	1,50	0,80	0,030	0,030	—	—	0,40 -0,65	—
MoL		0,07	0,60 -1,70	0,80	0,020	0,020	0,3	0,2	0,40 -0,65	0,03
MoV		0,07 -0,12	0,40 -1,00	0,80	0,020	0,020	0,3	0,30 -0,60	0,50 -0,80	0,25 -0,45
	CM	0,05 -0,12	1,50	0,80	0,030	0,030	—	0,40 -0,65	0,40 -0,65	—
	CML	0,05	1,50	0,80	0,030	0,030	—	0,40 -0,65	0,40 -0,65	—
CrMo1	(1CM)	0,05 -0,12	0,40 -1,30	0,80	0,020	0,020	0,3	0,90 -1,40	0,40 -0,65	0,03
(CrMo1)	1CM	0,05 -0,12	1,50	0,80	0,030	0,030	—	1,00 -1,50	0,40 -0,65	—
CrMo1L	(1CML)	0,05	0,40 -1,30	0,80	0,020	0,020	0,3	0,90 -1,40	0,40 -0,65	0,03
(CrMo1L)	1CML	0,05	1,50	0,80	0,030	0,030	—	1,00 -1,50	0,40 -0,65	—
	1CMH	0,10 -0,15	1,50	0,80	0,030	0,030	—	1,00 -1,50	0,40 -0,65	—
CrMo2	(2C1M)	0,05 -0,12	0,40 -1,30	0,80	0,020	0,020	0,3	2,00 -2,50	0,90 -1,30	0,03
(CrMo2)	2C1M	0,05 -0,12	1,50	0,80	0,030	0,030	—	2,00 -2,50	0,90 -1,20	—
CrMo2L	(2C1ML)	0,05	0,40 -1,30	0,80	0,020	0,020	0,3	2,00 -2,50	0,90 -1,30	0,03
(CrMo2L)	2C1ML	0,05	1,50	0,80	0,030	0,030	—	2,00 -2,50	0,90 -1,20	—
	2C1MH	0,10 -0,15	1,50	0,80	0,030	0,030	—	2,00 -2,50	0,90 -1,20	—
CrMo5	(5CM)	0,03 -0,12	0,40 -1,30	0,80	0,020	0,025	0,3	4,0 -6,0	0,40 -0,70	0,03
(CrMo5)	5CM	0,05 -0,10	1,50	1,00	0,030	0,030	0,40	4,0 -6,0	0,45 -0,65	—
	5CML	0,05	1,50	1,00	0,030	0,030	0,40	4,0 -6,0	0,40 -0,65	—
	9C1M	0,05 -0,10	1,50	1,00	0,030	0,030	0,40	8,0 -10,5	0,85 -1,20	—
	9C1ML	0,05	1,50	1,00	0,030	0,030	0,40	8,0 -10,5	0,85 -1,20	—
	9C1MV f	0,08 -0,13	1,20	0,50	0,020	0,015	1,00	8,0 -10,5	0,85 -1,20	0,15 -0,30
	9C1MV1g	0,03 -0,12	1,25 -2,00	0,50	0,020	0,015	1,00	8,0 -10,5	0,85 -1,20	0,15 -0,30
Z	G	Any other agreed composition								

- a) A designation in parentheses [e.g., (CrMo1) or (1CM)] indicates a near match in the other designation system, but not an exact match. The correct designation for a given composition range is the one without parentheses. A given product may, by having a more restricted chemical composition which fulfils both sets of designation requirements, be assigned both designations independently, provided that the mechanical property requirements of Table 2 are also satisfied.
- b) Single values shown in the table are maximum values
- c) If not specified: Cu < 0,3 %, Nb < 0,1 %.
- e) Elements listed without specified values shall be reported, if intentionally added. The total of these unspecified elements and all other elements found in the course of routine chemical analysis shall not exceed 0,50 %

## GUIDE TO EN ISO 17634-B: TUBULAR CORED ELECTRODES FOR GAS SHIELDED METAL ARC WELDING OF CREEP-RESISTING STEELS

T = Indicates a tubular cored electrode	Symbol	Min. yield strength MPa	Tensile strength MPa	Minimum elongation %	Symbol	Position a	PA = Flat position PB = Horizontal-vertical position PC = Transverse position PD = Horizontal overhead position PE = Overhead position PF = Vertical up position PG = Vertical down position	Symbol	Hydrogen content, ml/100 g deposited weld metal, max.
	49	390	490 - 670	18	0	PA, PB		H5	5
	55	460	550 - 740	17	1	PA, PB, PC, PD, PE, PF or PG, oder PF + PG		H10	10
	57	490	570 - 770	17				H15	15
	62	530	620 - 820	17					
69	565	690 - 890	17						

Gases according to ISO 14175

<b>T</b>	<b>55</b>	<b>T5</b>	<b>0</b>	<b>M21</b>	<b>1CM</b>	<b>H5</b>
----------	-----------	-----------	----------	------------	------------	-----------

Usability designator	Shielding gas	Operating polarity	Transfer of droplet	Welding position	Characteristic
T1	Required	d.c.(+)	Spray type	0 or 1	Rutil -Low spatter loss, flat to slightly convex bead and high deposition
T5	Required	d.c.(+)	Globular type	0 or 1	Basic Slightly convex bead, a thin slag without completely converging the weld bead, good impact properties and hot and cold crack resistance compared to T1
T15	Required	d.c.(+)	Very fine droplet to spray	0 or 1	Metal-Core consisting of metal alloys and iron powder, and minimal slag cover
TG	As agreed between purchaser and supplier				

Chemical composition symbols for classification according to		Minimum yield strength a) MPa	Tensile strength MPa	Minimum elongation %	Charpy V at +20°C		Preheating and fill layers Temp °C	PWHT	
ISO 3580-A d	Tensile strength and chemical composition ISO 3580-Be				Min ø	Min. single		Temp °C	Time min
Mo	(2M3)	355	510	22	47	38	< 200	570 -620	60
(Mo)	T49TX-X-2M3	390	490 -670	18	-	-	135 -165	605 -635	60
(Mo)	T55TX-X-2M3	460	550 -740	17	-	-	135 -165	605 -635	60
MoL		355	510	22	47	38	< 200	570 -620	60
MoV		355	510	18	47	38	200 -300	690 -730	60
	T55TX-X-CM	460	550 -740	17	-	-	160 -190	675 -705	60
	T55TX-X-CML	460	550 -740	17	-	-	160 -190	675 -705	60
CrMo1	(1CM)	355	510	20	47	38	150 -250	660 -700	60
(CrMo1)	T55TX-X-1CM	460	550 -740	17	-	-	160 -190	675 -705	60
CrMo1L	(1CML)	355	510	20	47	38	150 -250	675 -705	60
(CrMo1L)	T55TX-X-1CML	460	550 -740	17	-	-	160 -190	690 -750	60
	T55TX-X-1CMH	460	550 -740	17	-	-	160 -190	675 -750	60
CrMo2	(2C1M)	400	500	18	47	38	200 -300	690 -750	60
(CrMo2)	T62TX-X-2C1M	530	620 -820	15	-	-	160 -190	675 -705	60
(CrMo2)	T69TX-X-2C1M	600	690 -890	14	-	-	160 -190	675 -705	60
CrMo2L	(2C1ML)	400	500	18	47	38	200 -300	690 -750	60
(CrMo2L)	T62TX-X-2C1ML	530	620 -820	15	-	-	160 -190	675 -705	60
	T69TX-X-2C1MH	530	620 -820	15	-	-	160 -190	675 -705	60
CrMo5	(5CM)	400	590	17	47	38	200 -300	730 -760	60
(CrMo5)	T55TX-X-5CM	460	550 -740	17	-	-	150 -250	730 -760	60
	T55TX-X-5CML	460	550 -740	17	-	-	150 -250	730 -760	60
	T55TX-X-9C1M	460	550 -740	17	-	-	150 -250	730 -760	60
	T55TX-X-9C1ML	460	550 -740	17	-	-	150 -250	730 -760	60
	T69TX-X-9C1MV f	565	690 -890	14	-	-	150 -250	730 -760	60
	T69TX-X-9C1MV1f	565	690 -890	14	-	-	150 -250	730 -760	60
Z	G	Any other agreed composition							

a) A designation in parentheses [e.g., (CrMo1) or (1CM)] indicates a near match in the other designation system, but not an exact match. The correct designation for a given composition range is the one without parentheses. A given product may, by having a more restricted chemical composition which fulfils both sets of designation requirements, be assigned both designations independently, provided that the mechanical property requirements of Table 2 are also satisfied.

b) Single values shown in the table are maximum values

c) If not specified: Cu < 0,3 %, Nb < 0,1 %.

e) Elements listed without specified values shall be reported, if intentionally added. The total of these unspecified elements and all other elements found in the course of routine chemical analysis shall not exceed 0,50 %

## GUIDE TO EN ISO 17672-A/B: BRAZING - FILLER METALS

ISO 17672	AI 112	ISO 17672	B	AI88Si	575/585
-----------	--------	-----------	---	--------	---------

Class Ag: silver brazing filler metals										
Code	Ag	Cu	Zn	Cd	Sn	Si	Ni	Mn	Melting temperature (approximate)	
	min./max	min./max	min./max	min./max	min./max	min./max	min./max	min./max	Solidus °C	Liquidus °C
<b>Ag-Cu-Zn-Sn alloys</b>										
Ag 125	24,0/26,0	39,0/41,0	31,0/35,0	—/0,010	1,5/2,5	—/0,05	—/—	—/—	680	760
Ag 130	29,0/31,0	35,0/37,0	30,0/34,0	—/0,010	1,5/2,5	—/0,05	—/—	—/—	665	755
Ag 134	33,0/35,0	35,0/37,0	25,5/29,5	—/0,010	2,0/3,0	—/0,05	—/—	—/—	630	730
Ag 138	37,0/39,0	31,0/33,0	26,0/30,0	—/0,010	1,5/2,5	—/0,05	—/—	—/—	650	720
Ag 140	39,0/41,0	29,0/31,0	26,0/30,0	—/0,010	1,5/2,5	—/0,05	—/—	—/—	650	710
Ag 145	44,0/46,0	26,0/28,0	23,5/27,5	—/0,010	2,0/3,0	—/0,05	—/—	—/—	640	680
Ag 155	54,0/56,0	20,0/22,0	20,0/24,0	—/0,010	1,5/2,5	—/0,05	—/—	—/—	630	660
Ag 156	55,0/57,0	21,0/23,0	15,0/19,0	—/0,010	4,5/5,5	—/0,05	—/—	—/—	620	655
Ag 160	59,0/61,0	29,0/31,0	—/—	—/0,010	9,5/10,5	—/0,05	—/—	—/—	600	730
<b>Ag-Cu-Zn alloys</b>										
Ag 205	4,0/6,0	54,0/56,0	38,0/42,0	—/0,010	—/—	0,05/0,25	—/—	—/—	820	870
Ag 212	11,0/13,0	47,0/49,0	38,0/42,0	—/0,010	—/—	0,05/0,25	—/—	—/—	800	830
Ag 225	24,0/26,0	39,0/41,0	33,0/37,0	—/0,010	—/—	—/0,05	—/—	—/—	700	790
Ag 230	29,0/31,0	37,0/39,0	30,0/34,0	—/0,010	—/—	—/0,05	—/—	—/—	680	765
Ag 235	34,0/36,0	31,0/33,0	31,0/35,0	—/0,010	—/—	—/0,05	—/—	—/—	685	755
Ag 244	43,0/45,0	29,0/31,0	24,0/28,0	—/0,010	—/—	—/0,05	—/—	—/—	675	735
Ag 245	44,0/46,0	29,0/31,0	23,0/27,0	—/0,010	—/—	—/0,05	—/—	—/—	665	745
Ag 250	49,0/51,0	33,0/35,0	14,0/18,0	—/0,010	—/—	—/0,05	—/—	—/—	690	775
Ag 265	64,0/66,0	19,0/21,0	13,0/17,0	—/0,010	—/—	—/0,05	—/—	—/—	670	720
Ag 270	69,0/71,0	19,0/21,0	8,0/12,0	—/0,010	—/—	—/0,05	—/—	—/—	690	740
Ag 272a	71,0/73,0	27,0/29,0	—/—	—/0,010	—/—	—/0,05	—/—	—/—	780	780
<b>Ag-Cu-Zn-Cd alloys</b>										
Ag 326	24,0/26,0	29,0/31,0	25,5/29,5	16,5/18,5	—/—	—/0,05	—/—	—/—	605	720
Ag 330	29,0/31,0	27,0/29,0	19,0/23,0	19,0/23,0	—/—	—/0,05	—/—	—/—	600	690
Ag 335	34,0/36,0	25,0/27,0	19,0/23,0	17,0/19,0	—/—	—/0,05	—/—	—/—	605	700
Ag 340	39,0/41,0	18,0/20,0	19,0/23,0	18,0/22,0	—/—	—/0,05	—/—	—/—	595	630
Ag 345	44,0/46,0	14,0/16,0	14,0/18,0	23,0/25,0	—/—	—/0,05	—/—	—/—	605	620
Ag 350	49,0/51,0	14,5/16,5	14,5/18,5	17,0/19,0	—/—	—/0,05	—/—	—/—	625	635
Ag 351	49,0/51,0	14,5/16,5	13,5/17,5	15,0/17,0	—/—	—/0,05	2,5/3,5	—/—	635	655
<b>Ag-Cu-Zn-Ni-Mn alloys</b>										
Ag 425	24,0/26,0	37,0/39,0	31,0/35,0	—/0,010	—/—	—/0,05	1,5/2,5	1,5/2,5	705	800
Ag 427	26,0/28,0	37,0/39,0	18,0/22,0	—/0,010	—/—	—/0,05	5,0/6,0	8,5/10,5	680	830
Ag 440	39,0/41,0	29,0/31,0	26,0/30,0	—/0,010	—/—	—/0,05	1,5/2,5	—/—	670	780
Ag 449	48,0/50,0	15,0/17,0	21,0/25,0	—/0,010	—/—	—/0,05	4,0/5,0	7,0/8,0	680	705
Ag 450	49,0/51,0	19,0/21,0	26,0/30,0	—/0,010	—/—	—/0,05	1,5/2,5	—/—	660	705
Ag 454	53,0/55,0	37,5/42,5	4,0/6,0	—/0,010	—/—	—/0,05	0,5/1,5	—/—	720	855
Ag 456	55,0/57,0	41,0/43,0	—/—	—/0,010	—/—	—/0,05	1,5/2,5	—/—	770	895
Ag 463	62,0/64,0	27,5/29,5	—/—	—/0,010	5,0/7,0	—/0,05	2,0/3,0	—/—	690	800
Ag 485	84,0/86,0	—/—	—/—	—/0,010	—/—	—/0,05	—/—	14,0/16,0	960	970

**NOTE:** Maximum impurity limits applicable to all types are (% by mass) Al 0,001, Bi 0,030, P 0,008, Pb 0,025; total of all impurities = 0,15; total of all impurities for Ag 427, Ag 449 and Ag 485 = 0,30.

## GUIDE TO EN ISO 17672-A/B: BRAZING - FILLER METALS

ISO 17672

Al 112

ISO 17672

B

Al88Si

575/585

Class Al: aluminium and magnesium brazing filler metals														
Code	Si	Fe	Cu	Mn	Mg	Zn	Cd	Pb	Andere	Non-defined elements		Al	Melting temperature (approximate)	
	min./max	max.	min./max	max.	min./max	max.	max.	max.	min./max	max.	Total max.		Solidus °C	Liquidus °C
<b>Al-Si alloys</b>														
Al 105	4,5/6,0	0,6	—/0,30	0,15	—/0,20	0,10	0,010	0,025	Ti: —/0,15	0,05	0,15	Rest	575	630
Al 107	6,8/8,2	0,8	—/0,25	0,10	—/—	0,20	0,010	0,025	—/—	0,05	0,15	Rest	575	615
Al 110	9,0/11,0	0,8	—/0,30	0,05	—/0,05	0,10	0,010	0,025	Ti: —/0,20	0,05	0,15	Rest	575	590
Al 112	11,0/13,0	0,8	—/0,30	0,15	—/0,10	0,20	0,010	0,025	—/—	0,05	0,15	Rest	575	585
<b>Al-Si-Cu alloys</b>														
Al 210	9,3/10,7	0,8	3,3/4,7	0,15	—/0,15	0,20	0,010	0,025	Cr: —/0,15	0,05	0,15	Rest	520	585
<b>Al-Si-Mg alloys</b>														
Al 310	9,0/10,5	0,8	—/0,25	0,10	1,0/2,0	0,20	0,010	0,025	—/—	0,05	0,15	Rest	555	590
Al 311	9,0/10,5	0,8	—/0,25	0,10	1,0/2,0	0,20	0,010	0,025	Bi: 0,02/0,20	0,05	0,15	Rest	555	590
Al 315	9,0/10,5	0,8	—/0,25	0,10	0,20/1,0	0,20	0,010	0,025	—/—	0,05	0,15	Rest	559	591
Al 317	11,0/13,0	0,8	—/0,25	0,10	0,10/0,50	0,20	0,010	0,025	—/—	0,05	0,15	Rest	562	582
Al 319	10,5/13,0	0,8	—/0,25	0,10	1,0/2,0	0,20	0,010	0,025	—/—	0,05	0,15	Rest	559	579
<b>Al-Si-Zn alloys</b>														
Al 410	9,0/11,0	0,8	—/0,30	0,05	—/0,05	0,50/3,0	0,010	0,025	—/—	0,05	0,15	Rest	576	588
Al 415	10,5/13,0	0,8	—/0,25	0,10	—/—	0,50/3,0	0,010	0,025	—/—	0,05	0,15	Rest	576	609
<b>Mg alloys</b>														
Mg 001	0,05	0,005	0,05	0,15/1,5	Rest	1,7/2,3	0,010	0,025	Be: 0,0002/0,0008 Ni: —/0,005	0,05	0,30	8,3/9,7	443	599

Class Cu: copper brazing filler metals — Cu-Zn alloys									
Code	Cu	Zn	Sn	Si	Mn	Ni	Fe	Melting temperature (approximate)	
	min./max	max.	min./max	max.	min./max	max.	max.	Solidus °C	Liquidus °C
Cu 470	57,0/61,0	Rest	0,2/0,5	—/—	—/—	—/—	—/—	875	895
Cu 470a	58,5/61,5	Rest	—/—	0,2/0,4	—/—	—/—	—/—	875	895
Cu 471	56,0/60,0	Rest	0,2/0,5	0,15/0,2	0,05/0,25	—/—	—/—	870	900
Cu 670	58,5/61,5	Rest	—/0,2	0,15/0,4	0,05/0,25	—/—	—/—	870	900
Cu 671	56,0/62,0	Rest	0,5/1,5	0,1/0,5	0,2/1,0	0,2/1,5	—/—	870	900
Cu 680	56,0/60,0	Rest	0,8/1,1	0,1/0,2	0,2/0,5	0,2/0,8	0,2/1,2	870	890
Cu 681	56,0/60,0	Rest	0,8/1,1	0,04/0,2	0,01/0,50	—/—	0,2/1,2	870	890
Cu 773	46,0/50,0	Rest	—/—	0,15/0,2	—/—	9,0/11,0	—/—	890	920

**NOTE:** Maximum impurity limits applicable to all types are (% by mass) Al 0,01, As 0,01, Bi 0,01, Cd 0,010, Fe 0,25, Pb 0,025, Sb 0,01; total impurities (excluding Fe) 0,2.



## GUIDE TO EN ISO 17672-A/B: BRAZING - FILLER METALS

ISO 17672	CuP 178	ISO 17672	B	Cu95P	710/925
-----------	---------	-----------	---	-------	---------

Class CuP: Copper-phosphorus							
Code	Cu	P	Ag	other	Melting temperature (approximate)		Indicative minimum brazing temperature °C
	min./max	min./max	min./max	min./max	Solidus °C	Liquidus °C	
<b>CuP alloys</b>							
CuP 178	Remainder	4,8/5,3	—/—	—/—	710	925	790
CuP 179	Remainder	5,9/6,5	—/—	—/—	710	890	760
CuP 180	Remainder	6,6/7,4	—/—	—/—	710	820	730
CuP 181	Remainder	7,0/7,5	—/—	—/—	710	793	730
CuP 182	Remainder	7,5/8,1	—/—	—/—	710	770	720
<b>Ag-CuP alloys</b>							
CuP 279	Remainder	5,9/6,7	1,5/2,5	—/—	645	825	740
CuP 280	Remainder	6,8/7,2	1,8/2,2	—/—	643	788	740
CuP 281	Remainder	5,8/6,2	4,8/5,2	—/—	645	815	710
CuP 282	Remainder	6,5/7,0	4,8/5,2	—/—	643	771	710
CuP 283	Remainder	7,0/7,5	5,8/6,2	—/—	643	813	720
CuP 283a	Remainder	7,0/7,5	5,8/6,2	Ni 0,05/0,15	643	813	720
CuP 284	Remainder	4,8/5,2	14,5/15,5	—/—	645	800	700
CuP 285	Remainder	6,0/6,7	17,2/18,0	—/—	643	666	670
CuP 286	Remainder	6,6/7,5	17,0/19,0	—/—	645	645	650
<b>CuSn-Si-Sb alloys</b>							
Ag 326	Remainder	6,0/7,0	—/—	Sn 6,0/7,0 Si 0,01/0,4	635	675	645
Ag 330	Remainder	6,4/7,2	—/—	Sn 6,5/7,5	650	700	700
Ag 335	Remainder	5,6/6,4	—/—	Sb 1,8/2,2	690	825	740

**NOTE 1:** Maximum impurity limits applicable to all types are (% by mass) Al 0,01, Bi 0,030, Cd 0,010, Pb 0,025, Zn 0,05, Zn + Cd 0,05; total of all impurities = 0,25.

**NOTE 2:** These filler metals should never be used on ferrous metals, nickel alloys or copper alloys containing nickel

## GUIDE TO EN ISO 17672-A/B: BRAZING - FILLER METALS

ISO 17672

AI 112

ISO 17672

B

AI88Si

575/585

Class Cu: copper brazing filler metals — High Cu alloys											
Code	Cu (including Ag)	Sn	Ag	Ni	P	Bi	Al	Cu <sub>2</sub> O	Total impurity limits (see note)	Melting temperature (approximate)	
	min./max	min./max	min./max	min./max.	min./max	min./max	max.	max.	max	Solidus °C	Liquidus °C
<b>Copper-cuprous oxide</b>											
Cu 087	86,50	—/—	—/—	—/—	—/—	—/—	—	Rest	0,5	1085	1085
Cu 099	99,0	—/—	—/—	—/—	—/—	—/—	—	Rest	0,3 (excluding O)	1085	1085
<b>Copper (99,9 min.)</b>											
Cu 102	99,95	—/—	—/—	—/—	—/—	—/—	—	—	0,3 (excluding Ag)	1085	1085
Cu 110	99,90	—/—	—/—	—/—	—/—	—/—	—	—	0,4 (excluding O and Ag)	1085	1085
Cu 141	99,90	—/—	—/—	—/—	—/0,075	—/—	0,01	—	0,060 (excluding Ag, As and Ni)	1085	1085
<b>Cu-Ag alloy</b>											
Cu 188	Remainder	—/—	0,8/1,2	—/—	—/—	—/0,1	—	—	0,3 (including Bi 0,1 max.)	1070	1080
<b>Cu-Ni alloy</b>											
Cu 168	Remainder	—/—	—/—	2,5/3,5	—/—	0,02/0,05	—	—	0,15 (excluding Ag)	1085	1100
<b>Cu-Sn alloys</b>											
Cu 922	Remainder	5,5/7,0	—/—	—/—	0,01/0,40	—/—	—	—	Al 0,005 Zn 0,05, others 0,1; total 0,4	910	1040
Cu 925	Remainder	11,0/13,0	—/—	—/—	0,01/0,40	—/—	—	—		825	990

**NOTE:** Maximum impurity limit applicable to all types are (% by mass) Cd 0,010 and Pb 0,025.

Class Cu: copper brazing filler metals — Cu special alloys												
Code	Cu	Al	Fe	Mn	Ni	P	Si	Sn	Zn	Total impurity limits (see note)	Melting temperature (approximate)	
		min./max	min./max	min./max.	min./max	max	max.	min./max	max.	max	Solidus °C	Liquidus °C
<b>Cu-Si-Mn alloys</b>												
Cu 511	Remainder	0/0,01	0/0,03	0,1/0,4	0/0,1	0,015	0,1/0,4	0,5/1,0	—	0,1	1020	1050
Cu 521	Remainder	0/0,01	0/0,1	0,5/1,5	—	0,02	1,5/2,0	0,1/0,3	0,2	0,5	1030	1050
Cu 541	Remainder	0/0,05	0/0,2	0,7/1,3	—	0,05	2,7/3,2	—	0,4	0,5	980	1035
<b>Cu-Al alloys</b>												
Cu 551	Remainder	4,5/5,5	0/0,5	0,1/1,0	1,0/2,5	—	0/0,1	—	0,2	0,5	1040	1075
Cu 561	Remainder	7,0/9,0	0/0,5	0/0,5	0/0,5	—	0/0,2	0/0,1	0,2	0,2	1030	1040
Cu 565	Remainder	8,5/11,5	0,5/1,5	—	—	—	0/0,1	—	0,2	0,5	1030	1040
<b>Cu-Mn-Ni alloys</b>												
Cu 571	Remainder	7,0/85	2,0/4,0	11,0/14,0	1,5/3,0	—	0/0,1	—	0,15	0,5	945	985
Cu 595	Remainder	0/0,05	0/0,5	11,0/14,0	1,5/5,0	—	0/0,1	0/0,1	1,0	0,5	965	1000

**NOTE:** Maximum impurity limit applicable to all types are (% by mass) Cd 0,010 and Pb 0,025.

## GUIDE TO EN ISO 17672-A/B: BRAZING - FILLER METALS

ISO 17672

AI 112

ISO 17672

B

AI88Si

575/585

Class Ni: nickel (and cobalt brazing) filler metals															
Code	Ni	Co	Cr	Si	B	Fe	C	P	W	Cu	Mn	Mo	Nb	Melting temperature (approximate)	
	min./max	min./max	min./max	min./max	min./max	min./max	min./max	min./max	min./max	min./max	min./max	min./max	min./max	Solidus °C	Liquidus °C
<b>Ni-Cr-B alloys</b>															
Ni 600	Remainder	0,10	13,0/15,0	4,0/5,0	2,75/3,50	4,0/5,0	0,60/0,90	—/0,02	—/—	—/—	—/—	—/—	—/—	980	1060
Ni 610	Remainder	0,10	13,0/15,0	4,0/5,0	2,75/3,50	4,0/5,0	—/0,06	—/0,02	—/—	—/—	—/—	—/—	—/—	980	1070
Ni 612	Remainder	0,10	13,5/16,5	—/—	3,25/4,0	—/1,5	—/0,06	—/0,02	—/—	—/—	—/—	—/—	—/—	1055	1055
Ni 620	Remainder	0,10	6,0/8,0	4,0/5,0	2,75/3,50	2,5/3,5	—/0,06	—/0,02	—/—	—/—	—/—	—/—	—/—	970	1000
<b>Ni-Si-B alloys</b>															
Ni 630	Remainder	0,10	—/—	4,0/5,0	2,75/3,50	—/0,5	—/0,06	—/0,02	—/—	—/—	—/—	—/—	—/—	980	1040
Ni 631	Remainder	0,10	—/—	3,0/4,0	1,50/2,20	—/1,5	—/0,06	—/0,02	—/—	—/—	—/—	—/—	—/—	980	1070
<b>Ni-Cr-Si alloys</b>															
Ni 650	Remainder	0,10	18,5/19,5	9,75/10,50	—/0,03	—/—	—/0,06	—/0,02	—/—	—/—	—/—	—/—	—/—	1080	1135
Ni 655	Remainder	0,10	21,0/23,0	6,0/7,0	—/0,01	—/—	—/0,16	3,5/4,5	—/—	—/—	—/—	—/—	—/—	960	1079
Ni 660	Remainder	0,10	18,5/19,5	7,0/7,5	1,0/1,5	—/0,5	—/0,10	—/0,02	—/—	—/—	—/—	—/—	—/—	1065	1150
Ni 661	Remainder	0,10	4,5/15,5	7,0/7,5	1,1/1,6	—/1,0	—/0,06	—/0,02	—/—	—/—	—/—	—/—	—/—	1030	1125
<b>Ni-W-Cr alloys</b>															
Ni 670	Remainder	0,10	10,0/13,0	3,0/4,0	2,0/3,0	2,5/4,5	0,40/0,55	—/0,02	15,0/17,0	—/—	—/—	—/—	—/—	970	1105
Ni 671	Remainder	0,10	9,0/11,75	3,35/4,25	2,2/3,1	2,5/4,0	0,30/0,50	—/0,02	11,5/12,75	—/—	—/—	—/—	—/—	970	1095
<b>Ni-P alloys</b>															
Ni 700	Remainder	0,10	—/—	—/—	—/—	—/—	—/0,06	10,0/12,0	—/—	—/—	—/—	—/—	—/—	875	875
Ni 710	Remainder	0,10	13,0/15,0	—/0,10	—/0,2	—/0,2	—/0,06	9,7/10,5	—/—	—/—	—/0,04	—/—	—/—	890	890
Ni 720	Remainder	0,10	24,0/26,0	—/0,10	—/0,2	—/0,2	—/0,06	9,0/11,0	—/—	—/—	—/—	—/—	—/—	880	950
<b>Ni-Mn-Si-Cu alloys</b>															
Ni 800	Remainder	0,10	—/—	6,0/8,0	—/—	—/—	—/0,06	—/0,02	—/—	4,0/5,0	21,5/24,5	—/—	—/—	980	1010
<b>Ni-Cr-B-Si-Cu-Mo-Nb alloys</b>															
Ni 810	Remainder	0,10	7,0/9,0	3,8/4,8	2,75/3,50	—/0,4	—/0,06	—/0,02	—/—	2,0/3,0	—/—	1,5/2,5	1,5/2,5	970	1080
<b>Co-Ni-Si-W alloys</b>															
Co 900	16,0/18,0	Remainder	18,0/20,0	7,5/8,5	0,70/0,90	—/1,0	0,35/0,45	—/0,02	3,5/4,5	—/—	—/—	—/—	—/—	1120	1150

**NOTE:** Maximum impurity limits applicable to all types are (% by mass) Al 0,05, Cd 0,010, Pb 0,025, S 0,02, Se 0,005, Ti 0,05, Zr 0,05; if elements other than those given in this table or this note are found to be present, the amount of these elements shall be determined; the total of such other elements shall not exceed 0,50 %.

## GUIDE TO EN ISO 17672-A/B: BRAZING - FILLER METALS

ISO 17672

Al 112

ISO 17672

B

Al88Si

575/585

Class Pd: palladium bearing brazing filler metals								
Code	Ag	Cu	Pd	Mn	Ni	Co	Melting temperature (approximate)	
	min./max	min./max	min./max	min./max.	min./max	min./max	Solidus °C	Liquidus °C
Pd 287a	67,0/69,0	26,0/27,0	4,5/5,5	—/—	—/—	—/—	805	810
Pd 288a	94,5/95,5	—/—	4,5/5,5	—/—	—/—	—/—	970	1010
Pd 387a	57,0/59,0	31,0/32,0	9,5/10,5	—/—	—/—	—/—	825	850
Pd 388a	67,0/68,0	22,0/23,0	9,5/10,5	—/—	—/—	—/—	830	860
Pd 481a	64,5/65,5	19,5/20,5	14,5/15,5	—/—	—/—	—/—	850	900
Pd 483a	—/—	81,5/82,5	17,5/18,5	—/—	—/—	—/—	1080	1090
Pd 484a	51,5/52,5	27,5/28,5	19,5/20,5	—/—	—/—	—/—	875	900
Pd 485a	74,5/75,5	—/—	19,5/20,5	4,5/5,5	—/—	—/—	1000	1120
Pd 496a	—/—	—/—	20,5/21,5	30,5/31,5	47,0/49,0	—/—	1120	1120
Pd 587a	53,0/55,0	20,5/21,5	24,5/25,5	—/—	—/—	—/—	900	950
Pd 597a	73,0/75,0	—/—	32,0/33,5	2,5/3,5	—/—	—/—	1180	1200
Pd 647a	—/—	—/—	59,5/60,5	—/—	39,5/40,5	—/—	1235	1235
Pd 657a	—/—	—/—	64,0/66,0	—/—	—/0,06	—/—	1235	1252

**NOTE 1:** For Pd 287, Pd 288, Pd 387, Pd 388, Pd 481, Pd 483, Pd 484, Pd 587 and Pd 657, maximum impurity limits applicable are (% by mass) Al 0,0010, P 0,008, Ti 0,002, Zr 0,002; total of all impurities = 0,15.

**NOTE 2:** For Pd 485 and Pd 597, maximum impurity limits are (% by mass) Al 0,010, Ti 0,01, Zr 0,01; total of all impurities = 0,30.

Class Au: gold bearing brazing filler metals								
Code	Au	Cu	Ni	Pd	Ag	Others	Melting temperature (approximate)	
	min./max	min./max	min./max	min./max.	min./max	min./max	Solidus °C	Liquidus °C
Au 295 a	29,5/30,5	69,5/70,5	—/—	—/—	—/—	—/—	995	1020
Au 300	29,5/30,5	—/—	35,5/36,5	33,5/34,5	—/—	—/—	1135	1165
Au 351	34,5/35,5	61,0/63,0	2,5/3,5	—/—	—/—	—/—	975	1030
Au 354	34,5/35,5	64,5/65,5	—/—	—/—	—/—	—/—	990	1010
Au 375 a	37,0/38,0	62,0/63,0	—/—	—/—	—/—	—/—	980	1000
Au 503	49,5/50,5	49,5/50,5	—/—	—/—	—/—	—/—	955	970
Au 507	49,5/50,5	—/—	24,5/25,5	24,0/26,0	—/—	Co —/0,06	1100	1120
Au 625 a	62,0/63,0	37,0/38,0	—/—	—/—	—/—	—/—	930	940
Au 700	69,5/70,5	—/—	21,5/22,5	7,5/8,5	—/—	—/—	1005	1045
Au 752 a	74,5/75,5	—/—	24,5/25,5	—/—	—/—	—/—	950	990
Au 755	74,5/75,5	11,5/13,5	—/—	—/—	12,0/13,0	—/—	880	895
Au 800	79,5/80,5	19,5/20,5	—/—	—/—	—/—	—/—	890	890
Au 801 a	79,5/80,5	18,5/19,5	—/—	—/—	—/—	Fe 0,5/1,5	905	910
Au 827 a	81,5/82,5	—/—	17,5/18,5	—/—	—/—	—/—	950	950
Au 927	91,0/93,0	—/—	—/—	7,0/9,0	—/—	—/—	1200	1240

**NOTE:** Maximum impurity limits applicable to all types are (% by mass) Al 0,0010, Cd 0,010, P 0,008, Pb 0,025, Ti 0,002, Zr 0,002; total of all impurities = 0,15

## GUIDE TO EN ISO 17672-A/B: BRAZING - FILLER METALS

Codification systems					
ISO 17672	UNS number	ISO 3677	AWS	EN 1044	JIS
<b>Aluminium brazing filler metals</b>					
Al 105	A94109	B-Al95Si-575/630		AL 101	
Al 107	A94343	B-Al92Si-575/615	BAISi-2	AL 102	BA4343
Al 110	A94045	B-Al90Si-575/590	BAISi-5	AL 103	BA4045
Al 112	A94047	B-Al88Si-575/585	BAISi-4	AL 104	BA4047
Al 210	A94145	B-Al86SiCu-520/585	BAISi-3	AL 201	BA4145
Al 310	A94004	B-Al89SiMg-555/590	BAISi-7	AL 301	BA4004
Al 311	A94104	B-Al89SiMg(Bi)-555/590	BAISi-11	AL 302	BA4104
Al 315		B-Al90Si-559/591			BA4005
Al 317	A94147	B-Al88SiMg-562/582	BAISi-9		
Al 319		B-Al89SiMg-559/579			BA4N04
Al 410		B-Al87SiZn-576/588			BA4N45
Al 415		B-Al85SiZn-576/609			BA4N43
Mg 001		B-Mg88AlZnMn-443/599	BMg-1		
<b>Silver brazing filler metals</b>					
Ag 125	P07125	B-Cu40ZnAgSn-680/760	BAG-37	AG 108	
Ag 130	P07130	B-Cu36ZnAgSn-665/755		AG 107	
Ag 134	P07130	B-Cu36ZnAgSn-630/730		AG 106	BAG-7B
Ag 138	P07380	B-Ag38CuZnSn-650/720	BAG-34		BAG-34
Ag 140	P07401	B-Ag40CuZnSn-650/710	BAG-28	AG 105	BAG-28
Ag 145	P07145	B-Ag45CuZnSn-640/680	BAG-36	AG 104	BAG-7A
Ag 155	P07155	B-Ag55ZnCuSn-630/660		AG 103	
Ag 156	P07563	B-Ag56CuZnSn-620/655	BAG-7	AG 102	BAG-7
Ag 160	P07600	B-Ag60CuSn-600/730	BAG-18	AG 402	BAG-18
Ag 205	P07205	B-Cu55ZnAg(Si)-820/870		AG 208	
Ag 212	P07212	B-Cu48ZnAg(Si)-800/830		AG 207	
Ag 225	P07254	B-Cu40ZnAg-700/790		AG 205	BAG-20A
Ag 230	P07301	B-Cu38ZnAg-680/765	BAG-20	AG 204	BAG-20
Ag 230 a		B-CuZnAgNi-676/788			
Ag 235	P07351	B-Ag35CuZn-685/775	BAG-35		BAG-35
Ag 244	P07453	B-Ag44CuZn-675/735		AG 203	
Ag 245	P07453	BAG-45CuZn-665/745	BAG-5		BAG-5
Ag 250	P07503	B-Ag50CuZn-690/77	BAG-6		BAG-6
Ag 265	P07650	B-Ag65CuZn-670/720	BAG-9		BAG-9
Ag 270	P07700	B-Ag70CuZn-690/740	BAG-10		BAG-10
Ag 272	P07720	B-Ag72Cu-780	BAG-8	AG 401	BAG-8

## GUIDE TO EN ISO 17672-A/B: BRAZING - FILLER METALS

Codification systems					
ISO 17672	UNS number	ISO 3677	AWS	EN 1044	JIS
<b>Silver Brazing Alloys</b>					
Ag 326	P07252	B-Cu30ZnAgCd-605/765	BAG-33	AG 307	
Ag 330	P07300	B-Ag30CuCdZn-600/690		AG 306	
Ag 335	P07350	B-Ag35CuZnCd-610/700	BAG-2	AG 305	BAG-2
Ag 340	P07340	B-Ag40ZnCdCu-595/630		AG 304	
Ag 345	P07450	B-Ag45CdZnCu-605/620	BAG-1	AG 302	
Ag 350	P07500	B-Ag50CdZnCu-620/640	BAG-1a	AG 301	BAG-1
Ag 351	P07501	B-Ag50CdZnCuNi-635/655	BAG-3	AG 351	BAG-1A
Ag 425	P07250	B-Cu38ZnAgNiMn-705/800	BAG-26		BAG-26
Ag 427	P07427	B-Cu38AgZnMnNi-680/830		AG 503	
Ag 440	P07440	B-Ag40CuZnNi-670/780	BAG-4		BAG-4
Ag 449	P07490	B-Ag49ZnCuMnNi-680/705	BAG-22	AG 502	BAG-22
Ag 450	P07505	B-Ag50CuZnNi-660/705	BAG-24		BAG-24
Ag 454	P07540	B-Ag54CuZnNi-720/855	BAG-13		BAG-13
Ag 456	P07560	B-Ag56CuNi-770/895	BAG-13a		BAG-13A
Ag 456 a		B-Ag56CuInNi-600/710		AG 403	
Ag 463	P07630	B-Ag63CuSn-690/800	BAG-21		BAG-21
Ag 485	P07850	B-Ag85Mn-960/970	BAG-23	AG 501	BAG-23
<b>Copper-phosphorus brazing alloys</b>					
CuP 178	C55178	B-Cu95P-710/925			BCuP-1
CuP 179	C55179	B-Cu94P-710/890		CP 203	
CuP 180	C55182	B-Cu93P-710/820		CP 202	BCuP-2
CuP 181	C55181	B-Cu93P-710/793	BCuP-2		
CuP 182	C55181	B-Cu92P-710/770		CP 201	
CuP 279	C55279	B-Cu92PAg-645/825		CP 105	
CuP 280	C55280	B-Cu91PAg-643/788	BCuP-6		BCuP-6
CuP 281	C55281	B-Cu89PAg-645/815	BCuP-3		
CuP 281 a		B-Cu87PAg(Ni)-643/720		CP 104	
CuP 282	C55282	B-Cu88PAg-643/771	BCuP-7		BCuP-7
CuP 283	C55283	B-Cu87PAg-643/813	BCuP-4		BCuP-4
CuP 283 a				CP 103	
CuP 284	C55284	B-Cu80AgP-645/800	BCuP-5	CP 102	BCuP-5
CuP 285	C55385	B-Cu76AgP-643/666	BCuP-8		
CuP 286	C55385	B-Cu75AgP-645		CP 101	BCuP-8
CuP 385	C55385	B-Cu87PSnSi-635/675	BCuP-9		BCuP-9
CuP 386	C55385	B-Cu86SnP-650/700		CP 302	
CuP 389	C55389	B-Cu92PSb-690/825		CP 301	

## GUIDE TO EN ISO 17672-A/B: BRAZING - FILLER METALS

Codification systems					
ISO 17672	UNS number	ISO 3677	AWS	EN 1044	JIS
<b>Copper brazing filler metals</b>					
Cu 087		B-Cu87-1085	BCu-2		BCu-2
Cu 099		B-Cu99-1085	BCu-1a	CU 103	BCu-1A
Cu 102	C10200	B-Cu100-1085	BCu-3	CU 102	
Cu 110	C11000	B-Cu100-1085	BCu-1b	CU 101	BCu-1
Cu 141	C14180	B-Cu100(P)-1085	BCu-1	CU 104	
Cu 186	C18601	B-Cu97Ni(B)-1085/1100		CU 105	
Cu 188	C18803	B-Cu99(Ag)-1070/1080		CU 106	
Cu 922	C92201	B-Cu94Sn(P)-910/1040		CU 201	
Cu 925	C92501	B-Cu88Sn(P)-825/990		CU 202	
Cu 470	C47000	B-Cu60Zn(Sn)-875/895	RBCuZn-A	CU 302	BCu-6
Cu 470a		B-Cu60Zn(Si)-875/895		CU 301	BCu-5
Cu 471	C47100	B-Cu60Zn(Sn)(Si)(Mn)-870/900		CU 304	
Cu 670	C68000	B-Cu60Zn(Si)(Mn)-870/900		CU 303	
Cu 671		B-Cu60ZnSn(Ni)(Mn)(Si)-870/890		CU 306	
Cu 680		B-Cu58ZnSn(Fe)(Ni)(Mn)- 866/882	RBCuZn-B		
Cu 681	C68100	B-Cu58ZnSn(Fe)(Mn)(Si)- 866/888	RBCuZn-C		
Cu 773	C77300	B-Cu48ZnNi(Si)-890/920	RBCuZn-D	CU 305	BCu-8
Cu 511		B-Cu98SnMnSi-1020/105			
Cu 521		B-Cu97SiMn-1030/1050			
Cu 541		B-Cu96SiMn-980/1035			
Cu 551		B-Cu92AlNiMn-1040/1075			
Cu 561		B-Cu92Al-1030/1040			
Cu 565		B-Cu89AlFe-1030/1040			
Cu 571		B-Cu74MnAlFeNi-945/985			
Cu 595		B-Cu84MnNi-965/1000			
<b>Nickel and cobalt brazing filler materials</b>					
Ni 600		B-Ni73CrFeSiB(C)-980/1060	BNi-1	NI101	BNi-1
Ni 610	N99610	B-Ni74CrFeSiB-980/1070	BNi-1a	NI 1A1	BNi-1A
Ni 612	N99612	B-Ni81CrB-1055	BNi-9	NI 109	BNi-9
Ni 620	N99620	B-Ni82CrSiBFe-970/1000	BNi-2	NI 102	BNi-2
Ni 630	N99630	B-Ni92SiB-980/1040	BNi-3	NI 103	BNi-3
Ni 631	N99640	B-Ni95SiB-980/1070	BNi-4	NI 104	BNi-4
Ni 650	N99650	B-Ni71CrSi-1080/1135	BNi-5	NI 105	BNi-5
Ni 655		B-Ni68CrSiP-960/1079			
Ni 660	N99651	B-Ni73CrSiB-1065/1150	BNi-5a		BNi-5A
Ni 661	N99652	B-Ni77CrSiBFe-1030/1125	BNi-5b		BNi-5B
Ni 670	N99622	B-Ni63WCrFeSiB-970/1105	BNi-10	NI 110	BNi-10
Ni 671	N99624	B-Ni67WCrSiFeB-970/1095	BNi-11	NI 111	BNi-11
Ni 700	N99700	B-Ni89P-875	BNi-6	NI 106	BNi-6
Ni 710	N99710	B-Ni76CrP-890	BNi-7	NI 107	BNi-7
Ni 720	N99720	B-Ni65CrP-880/950	BNi-12	NI 112	BNi-12
Ni 800	N99800	B-Ni66MnSiCu-980/1010	BNi-8	NI 108	BNi-8
Ni 810	N99810	B-Ni78CrSiBCuMoNb-970/1080	BNi-13		BNi-13
Co 900	R39001	B-Co51CrNiSiW(B)-1120/1150	BCo-1	CO 101	BCo-1



## GUIDE TO EN ISO 17672-A/B: BRAZING - FILLER METALS

Codification systems					
ISO 17672	UNS number	ISO 3677	AWS	EN 1044	JIS
<b>Palladium bearing brazing filler metals</b>					
Pd 287	P07287	B-Ag68CuPd-805/810	BVAg-30	PD 106	BPd-1
Pd 288	P07288	B-Ag95Pd-970/1010		PD 204	BPd-7
Pd 387	P07387	B-Ag58CuPd-825/850	BVAg-31	PD 105	BPd-2
Pd 388	P07388	B-Ag68CuPd-830/860		PD 104	BPd-3
Pd 481	P07481	B-Ag65CuPd-850/900		PD 103	BPd-4
Pd 483	P07483	B-Cu82Pd-1080/1090		PD 203	BPd-8
Pd 484	P07484	B-Ag52CuPd-875/900		PD 102	BPd-5
Pd 485	P07485	B-Ag75PdMn-1000/1120		PD 202	BPd-9
Pd 496	P07496	B-Ni48MnPd-1120			BPd-11
Pd 587	P07587	B-Ag54PdCu-900/950	BVAg-32	PD 101	BPd-6
Pd 597	P07597	B-Ag74PdMn-1180/1200			BPd-10
Pd 647	P07647	B-Pd60Ni-1235		PD 201	BPd-14
Pd 657	P07657	BPd65Co-1235/1252	BPVPd-1	PD 301	
<b>Gold bearing brazing filler metals</b>					
Au 295	P00295	B-Cu70Au-995/1020		AU 104	BAu-1A
Au 300	P00300	B-Ni36PdAu-1135/1166	BAu-5		BAu-5
Au 351	P00350	B-Cu62AuNi-975-1030	BAu-3		BAu-3
Au 354	P00354	B-Cu65Au-990/1020	BVAu-9		
Au 375	P00375	B-Cu62Au-980/1000	BAu-1	AU 103	BAu-1
Au 503	P00503	B-Au50Cu-955/970	BVAu-10		BAu-11
Au 507	P00507	B-Au50NiPd-1102/1121	BVAu-7		
Au 625	P00625	B-Au62Cu-930/940		AU 102	
Au 700	P00700	B-Au70NiPd-1007/1046	BAu-6		BAu-6
Au 752	P00752	B-Au75Ni-950/990		AU 106	
Au 755	P00753	B-Au75AgCu-880/895			BAu-12
Au 800	P00800	B-Au80Cu-890	BAu-2		BAu-2
Au 801	P00807	B-Au80Cu(Fe)-905/910		AU 101	
Au 827	P00827	B-Au82Ni-950	BAu-4	AU 105	
Au 927	P00927	B-Au92Pd-1200/1240	BVAu-8		

## GUIDE TO EN ISO 17777-A/B: COVERED ELECTRODES FOR MANUAL METAL ARC WELDING OF COPPER AND COPPER ALLOYS

E = Covered electrode

E (Z)Cu

Z = Agreed between manufacturer and customer

Chemical composition symbols for classification according to		Chemical composition, % b) c)																	
numerical	chemical	AWS 5.6	UNS	Cu	Al	Fe	Mn	Ni+Co	P	Pb	Si	Sn	Zn	As	C	Ti	S	Other elements	
<b>COPPER LOW ALLOYED</b>																			
Cu 1892	Cu	ECu	C18920	rest	0,01	0,2	0,10	-	-	0,01	0,10	-	-	-	-	-	-	0,50	
Cu 1893	CuMn2	-	C18930	≥ 95	-	1,0	1,0-3,0	0,3	0,10	0,01	0,8	1,0	-	0,05	-	-	-	0,5	
Cu 1893A	CuMn2(A)	-	C18930	≥ 95	-	-	3,0	-	0,30	0,02	0,5	-	-	-	-	-	-	0,50	
<b>COPPER-SILICON (SILICON BRONZE)</b>																			
Cu 6511	CuSi2Mn	-	C65110	≥ 93	-	-	3,0	--	0,30	0,02	1,0-2,0	-	-	--	--	--	--	0,5	
Cu 6560	CuSi3Mn	-	C65600	≥ 92	-	-	3,0	--	0,30	0,02	2,5-4,0	-	-	--	--	--	--	0,5	
Cu 6561	CuSi3	-	C65610	rest	0,01	0,5	1,5	--	--	0,02	2,4-4,0	1,5	-	--	--	--	--	0,5	
<b>COPPER TIN (including PHOSPHORICAL BRONZE)</b>																			
Cu 5180	CuSn5P	ERCuSn-A	C51800	rest	0,01	0,25	--	--	0,05-0,35	0,02	--	4,0-6,0	--	--	--	--	--	0,5	
Cu 5180A	CuSn6P	-	C51800	rest	-	-	--	-	0,30	0,02	-	5,0-7,0	-	-	-	-	-	0,50	
Cu 5180B	CuSn7	-	C51800	rest	0,1	0,20	1,0	-	1,0	0,02	0,5	5,0-8,0	0,1	-	-	-	-	0,5	
Cu 5210	CuSn8P	ERCuSn-C	C52100	rest	0,01	0,25	-	-	0,05-0,35	0,02	-	7,0-9,0	-	-	-	-	-	0,50	
Cu 5210(A)	CuSn8P(A)	-	C52100	rest	-	-	-	-	0,30	0,02	-	7,0-9,0	-	-	-	-	-	0,50	
Cu 5410	CuSn13	-	C54100	rest	0,01	0,2	1,0	-	0,10	0,02	0,5	11,0-13,0	0,1	-	-	-	-	0,2	
<b>COPPER-ALUMINIUM (ALUMINIUM BRONZE)</b>																			
Cu 6100	CuAl8Fe3	-	C61000	rest	6,0-8,5	c	0,5	c	--	0,02	0,2	c	0,2	--	--	--	--	0,4 c	
Cu 6100 (A)	CuAl9	-																	
Cu 6240	CuAl11Fe3	ERCuAl-A3	C62400	rest	10,0-11,5	2,0-4,5	--	--	--	0,02	0,1	--	0,1	--	--	--	--	0,5	
Cu 6325	CuAl8Fe4Mn2Ni2	-	C63250	rest	7,0-9,0	1,8-5,0	0,5-3,0	0,5-3,0	--	0,02	0,1	--	0,1	--	--	--	--	0,4	
Cu 6327	CuAl8Ni2Fe2Mn2	-	C63270	rest	7,0-9,5	0,5-2,5	0,5-2,5	0,5-3,0	--	0,02	0,2	--	0,2	--	--	--	--	0,4	
Cu 6328	CuAl9Ni5Fe3Mn2	ERCuNiAl	C63280	rest	8,5-9,5	3,0-5,0	0,6-3,5	4,0-5,5	--	0,02	0,1	--	0,1	--	--	--	--	0,5	
<b>COPPER MANGANESE</b>																			
Cu 6338	CuMn13Al8Fe3Ni2	ERCuMnNiAl	C63380	rest	6,0-8,5	2,0-4,0	11,0-14,0	1,5-3,0	-	0,02	1,5	-	-	-	-	-	-	0,50	
<b>COPPER NICKEL</b>																			
Cu 7061	CuNi10	-	C70610	rest	--	2,5	2,5	9,0-11,0	0,020	0,02	0,5	-	-	-	-	0,5	0,015	0,50	
Cu 7158	CuNi30Mn2FeTi	ERCuNi	C71581	rest	--	0,40-0,75	1,00-2,5	29,0-33,0	0,020	0,02	0,50	-	-	-	-	0,50	0,015	0,50	
Cu 7158(A)	CuNi30Mn1Fe2Ti	-	C71581	rest	-	2,5	2,5	29,0-33,0	0,020	0,02	0,5	-	-	-	-	0,5	0,015	0,50	

a) The elements for which specific values are given in this table shall be analyzed. However, if the analysis carried out in accordance with the rules provides evidence of the presence of other elements, the table shall be replaced by an additional analysis to show that the sum of these other elements does not exceed the declared maximum level.

b) Single values are maxima, unless otherwise noted.

c) The sum of all other elements, including those for which a maximum value or an asterisk is indicated, shall not exceed the value indicated in ,Other sum

d) Z = Agreed between manufacturer and customer

## GUIDE TO EN ISO 17777-A/B: COVERED ELECTRODES FOR MANUAL METAL ARC WELDING OF COPPER AND COPPER ALLOYS

## Additional Info

## Iso 17777 in comparison AWS ASME 5.6

Alloy type	UNS Number	ISO 17777	Common Name	Composition, Weight Percent a) b)												
				Cu (+Ag)	Zn	Sn	Mn	Fe	Si	Ni(+Co)	P	Al	Pb	Ti	andere	
ERCu	C18980	Cu EC18980	Copper	98.0 min	-	1.0	0.50	-	0.50	-	-	0.15	0.01	0.02	-	0.50
ERCuSi-A	C65600	CuSi3Mn EC65600	Silicon bronze (copper-si- licon)	Rest	1.0	1.0	1.5	0.50	2.8- 4.0	-	-	-	0.01	0.02	-	0.50
ERCuSn-A	C51800	CuSn5P EC51800	Phosphor bronze (cop- per-tin)	Rest	-	4.0-6.0	-	-	-	-	-	0.10-0.35	0.01	0.02	-	0.50
ERCuSn-C	C52100	CuSn8P EC52100	Phosphor bronze (cop- per-tin)	Rest	0.20	7.0-9.0	-	0.10	-	-	-	0.10-0.35	0.01	0.02	-	0.50
ERCuNi	C71581	Cu- Ni30Mn2F- eTi EC71581	Copper-nickel	Rest	-	-	1.0	0.40- 0.75	0.25	29.0-32.0	0.02	-	0.02	0.20-0.50	0.50	
ERCuAl-A1	C61000	CuAl8Fe3 EC61000	Aluminum bronze	Rest	0.20	-	0.50	-	0.10	-	-	-	6.0- 8.5	0.02	-	0.50
ERCuAl-A2	C61800	EC61800	Aluminum bronze	Rest	0.20	-	-	1.5	0.10	-	-	-	8.5- 11.0	0.02	-	0.50
ERCuAl-A3	C62400	CuAl11Fe3 EC62400	Aluminum bronze	Rest	0.10	-	-	2.0- 4.5	0.10	-	-	-	10.0- 11.5	0.02	-	0.50
ERCuNiAl	C63280	CuAl9Ni- 5Fe3Mn2 EC63280	Nickel-alumi- num bronze	Rest	0.10	-	0.60- 3.50	3.0- 5.0	0.10	4.0- 5.5	-	-	8.50- 9.50	0.02	-	0.50
ERCuMnNiAl	C63380	CuMn 13Al8Fe3Ni2 EC63380	Manganese-ni- ckel aluminum bronze	Rest	0.15	-	11.0- 14.0	2.0- 4.0	0.10	1.5- 3.0	-	-	7.0- 8.5	0.02	-	0.50

**NOTES:**

- a) Analysis shall be made for the elements for which specific values are shown in this table. If, however, the presence of other elements is indicated in the course of routine analysis, further analysis shall be made to determine that the total of these other elements is not present in excess of the limits specified for 'Total other elements' in the last column in this table.
- b) Single values shown are maximum, unless otherwise noted.
- c) ASTM DS-56/SAE HS-1086, Metals & Alloys in the Unified Numbering System.
- d) Sulfur shall be 0.01% maximum for the ERCuNi classification.
- e) Ag may or may not be present.
- f) Ag may or may not be present.

## GUIDE TO EN ISO 18273: WIRE ELECTRODES, WIRES AND RODS FOR WELDING OF ALUMINIUM AND ALUMINIUM ALLOYS

S = Solid wire and rod

ISO 18273	S	Al 4043	ISO 18273	S	Al 4043	(AISI5)
-----------	---	---------	-----------	---	---------	---------

Alloy Symbol	Si	Fe	Cu	Mn	Mg	Cr	Zn	Ga,V	Ti	Zr	Al	Be	Other each	Other each	
Numerical	Chemical	min./max	min./max	min./max	min./max	min./max	min./max	min./max	min./max	min./max	min./max	min./max			
<b>ALUMINIUM-LOW ALLOYED</b>															
Al 1070	Al99,7	0,20	0,25	0,04	0,03	0,03	-	0,04	V 0,05	0,03	-	99,7	0,0003	0,03	-
Al 1080A	Al99,8(A)	0,15	0,15	0,03	0,02	0,02	-	0,06	Ga 0,03	0,02	-	99,8	0,0003	0,02	-
Al 1188	Al 99,88	0,06	0,06	0,005	0,01	0,01	-	0,03	Ga 0,03 V 0,05	0,01	-	99,88	0,0003	0,01	-
Al 1100	Al99,0Cu	Si+Fe 0,95	Si+Fe 0,95	0,05-0,20	0,05	-	-	0,10	-	-	-	99,00	0,0003	0,05	0,15
Al 1200	Al99,0	Si+Fe 1,00	Si+Fe 1,00	0,05	0,05	-	-	0,10	-	0,05	-	99,00	0,0003	0,05	0,15
Al 1450	Al99,5Ti	0,25	0,40	0,05	0,05	0,05	-	0,07	-	0,10-0,20	-	99,50	0,0003	0,03	-
<b>ALUMINIUM-COPPER</b>															
Al 2319	AlCu6MnZrTi	0,20	0,30	5,8-6,8	0,20-0,40	0,02	-	0,10	V0,05-0,15		0,10-0,25	Rem	0,0003	0,05	0,15
<b>ALUMINIUM-MANGANESE</b>															
Al 3103	AlMn 1	0,50	0,7	0,10	0,9-1,5	0,30	0,10	0,20	-	Ti + Zr 0,10	Ti + Zr 0,10	Rem	0,0003	0,05	0,15
<b>ALUMINIUM-SILICIUM</b>															
Al 4009	AlSi5Cu1Mg	4,5-5,5	0,20	1,0-1,5	0,10	0,45-0,60	-	0,10	-	0,20	-	Rem	0,0003	0,05	0,15
Al 4010	AlSi7Mg	6,5-7,5	0,20	0,20	0,10	0,30-0,45	-	0,10	-	0,20	-	Rem	0,0003	0,05	0,15
Al 4011	AlSi7Mg0,5Ti	6,5-7,5	0,20	0,20	0,10	0,45-0,7	-	0,10	-	0,04-0,20	-	Rem	0,04-0,07	0,05	0,15
Al 4018	AlSi7Mg	6,5-7,5	0,20	0,05	0,10	0,50-0,8	-	0,10	-	0,20	-	Rem	0,0003	0,05	0,15
Al 4043	AlSi5	4,5-6,0	0,8	0,30	0,05	0,05	-	0,10	-	0,20	-	Rem	0,0003	0,05	0,15
Al 4043A	AlSi5(A)	4,5-6,0	0,6	0,30	0,15	0,20	-	0,10	-	0,15	-	Rem	0,0003	0,05	0,15
Al 4046	AlSi10Mg	9,0-11,0	0,50	0,03	0,40	0,20-0,50	-	0,10	-	0,15	-	Rem	0,0003	0,05	0,15
Al 4047	AlSi12	11,0-13,0	0,8	0,30	0,15	0,10	-	0,20	-	-	-	Rem	0,0003	0,05	0,15
Al 4047A	AlSi12(A)	11,0-13,0	0,6	0,30	0,15	0,10	-	0,20	-	0,15	-	Rem	0,0003	0,05	0,15
Al 4145	AlSi10Cu4	9,3-10,7	0,8	3,3-4,7	0,15	0,15	0,15	0,20	-	-	-	Rem	0,0003	0,05	0,15
Al 4643	AlSi4Mg	3,6-4,6	0,8	0,10	0,05	0,10-0,30	-	0,10	-	0,15	-	Rem	0,0003	0,05	0,15
<b>ALUMINIUM-MAGNESIUM</b>															
Al 5249	AlMg2Mn0,8Zr	0,25	0,40	0,05	0,50-1,1	1,6-2,5	0,30	0,20	-	0,15	0,10-0,20	Rem	0,0003	0,05	0,15
Al 5554	AlMg2,7Mn	0,25	0,40	0,10	0,50-1,0	2,4-3,0	0,05 - 0,20	0,25	-	0,05-0,20	-	Rem	0,0003	0,05	0,15
Al 5654	AlMg3,5Ti	Si + Fe 0,45		Si+Fe 0,45	0,01	3,1-3,9	0,15-0,35	0,20	-	0,04-0,15	-	Rem	0,0003	0,05	0,15
Al 5654A	AlMg3,5Ti	Si + Fe 0,45		Si+Fe 0,45	0,01	3,1-3,9	0,15-0,35	0,20	-	0,04-0,15	-	Rem	0,0005	0,05	0,15
Al 5754c	AlMg3	0,40	0,40	0,10	0,50	2,6-3,6	0,30	0,20	-	0,15	-	Rem	0,0003	0,05	0,15
Al 5356	AlMg5Cr(A)	0,25	0,40	0,10	0,05-0,20	4,7 - 5,5	0,05 - 0,20	0,10	-	0,06 - 0,20	-	Rem	0,0003	0,05	0,15
Al 5356A	AlMg5Cr(A)	0,25	0,40	0,10	0,05-0,20	4,5 - 5,5	0,05 - 0,20	0,10	-	0,06 - 0,20	-	Rem	0,0005	0,05	0,15
Al 5556	AlMg5Mn1Ti	0,25	0,40	0,10	0,50-1,0	4,7 - 5,5	0,05 - 0,20	0,25	-	0,05 - 0,20	-	Rem	0,0003	0,05	0,15
Al 5556C	AlMg5Mn1Ti	0,25	0,40	0,10	0,50-1,0	4,7 - 5,5	0,05 - 0,20	0,25	-	0,05 - 0,20	-	Rem	0,0005	0,05	0,15
Al 5556A	AlMg5Mn	0,25	0,40	0,10	0,6-1,0	5,0 - 5,5	0,05 - 0,20	0,20	-	0,05 - 0,20	-	Rem	0,0003	0,05	0,15
Al 5556B	AlMg5Mn	0,25	0,40	0,10	0,6-1,0	5,0 - 5,5	0,05 - 0,20	0,20	-	0,05 - 0,20	-	Rem	0,0005	0,05	0,15
Al 5183	AlMg4,5Mn0,7(A)	0,40	0,40	0,10	0,50-1,0	4,3 - 5,2	0,05 - 0,25	0,25	-	0,15	-	Rem	0,0003	0,05	0,15
Al 5183A	AlMg4,5Mn0,7(A)	0,40	0,40	0,10	0,50-1,0	4,3 - 5,2	0,05 - 0,25	0,25	-	0,15	-	Rem	0,0005	0,05	0,15
Al 5087	AlMg4,5MnZr	0,25	0,40	0,05	0,7-1,1	4,5 - 5,2	0,05 - 0,25	0,25	-	0,15	0,10-0,20	Rem	0,0003	0,05	0,15
Al 5187	AlMg4,5MnZr	0,25	0,40	0,05	0,7-1,1	4,5 - 5,2	0,05 - 0,25	0,25	-	0,15	0,10-0,20	Rem	0,0005	0,05	0,15

a) Single values shown in the table are maximum values, except for Al.

b) The results shall be rounded to the same number of significant figures as in the specified value using the rules in accordance with annex B, Rule A of ISO 31-0:1992.

c) Alloy Al 5754 also limits the sum (Mn + Cr): 0,10 to 0,6.

**NOTE:** Consumables not listed in the Table can be symbolized by Al Z. Chemical symbol established by the manufacturer may be added in brackets

## GUIDE TO EN ISO 18274: WIRE AND STRIP ELECTRODES, WIRES AND RODS FOR FUSION WELDING OF NICKEL AND NICKEL ALLOYS

S = solid wire and rod / B = solid strip

ISO 18274			S/B	S Ni 6625			ISO 18274			S/B	S Ni6625			(NiCr22Mo9Nb)		
Alloy Symbol	C	Mn	Fe	Si	Cu	Ni	Co	Al	Ti	Cr	Nb	Mo	W	Other total		
Numerical ISO	Chemical ISO	Numerical AWS	min./max	min./max	min./max	min./max	min./max	min./max	min./max	min./max	min./max	min./max	min./max			
<b>NICKEL</b>																
Ni 2061	NiTi3	ERNi-1	0,15	1,0	1,0	0,7	0,2	≥92,0	-	1,5	2,0-3,5	-	-	-		
<b>NICKEL – COPPER</b>																
Ni 4060	NiCu30Mn3Ti	ERNiCu-7	0,15	2,0-4,0	2,5	1,2	28,0-32,0	≥62,0	-	1,2	1,5-3,0	-	-	-		
Ni 4061	NiCu30Mn3Nb		0,15	4,0	2,5	1,25	28,0-32,0	≥60,0	-	1,0	1,0	-	3,0	-		
Ni 5504	NiCu25Al3Ti	ERNiCu-8	0,25	1,5	2,0	1,0	20,0-	63,0-70,0	-	2,0-4,0	0,3-1,0	-	-	-		
<b>NICKEL – CHROMIUM</b>																
Ni 6072	NiCr44Ti	ERNiCr-4	0,01-0,10	0,20	0,50	0,20	0,50	≥52,0	-	-	0,3-1,0	42,0-46,0	-	-		
Ni 6073	NiCr38AlNbTi	ERNiCr-7	0,03	0,50	1,0	0,30	0,30	≥63,0	1,0	0,75-1,20	0,25-0,75	36,0-39,0	0,25-1,00	0,50	P 0,02 S 0,015 B 0,003 Zr 0,02	
Ni 6076	NiCr20	ERNiCr-6	0,08-0,25	1,0	2,00	0,30	0,50	≥75,0	-	0,4	0,5	19,0-21,0	-	-		
Ni 6082	NiCr20Mn3Nb	ERNiCr-3	0,10	2,5-3,5	3,0	0,5	0,50	≥67,0	-	-	0,7	18,0-22,0	2,0-3,0	-		
<b>NICKEL – CHROMIUM – IRON</b>																
Ni 6002	NiCr21F-e18Mo9	ERNiCrMo-2	0,05-0,15	2,0	17,0-20,0	1,0	0,5	≥44,0	0,5-2,5	-	-	20,5-23,0	-	8,0-10,0	0,2-1,0	-
Ni 6025	NiCr25Fe10AlY	ERNiCrFe-12	0,05-0,25	0,5	8,0-11,0	0,5	0,1	≥59,0	-	1,8-2,4	0,1-0,2	24,0-26,0	-	-	Y 0,05 - 0,12 Zr 0,01-0,1	
Ni 6030	NiCr30F-e15Mo5W	ERNiCrMo-11	0,03	1,5	13,0-17,0	0,8	1,0-2,4	≥36,0	5,0	-	-	28,0-31,5	0,3-1,5	4,0-6,0	1,5-4,0	P 0,04 S 0,02
Ni 6045	NiCr28Fe23Si3	ERNiCrF-eSi-1	0,05-0,12	1,0	21,0-25,0	2,5-3,0	0,3	≥40,0	1,0	0,30	-	26,0-29,0	-	-	P 0,02 S 0,01	
Ni 6052	NiCr30Fe9	ERNiCrFe-7	0,04	1,0	7,0-11,0	0,5	0,30	≥54,0	-	1,1	1,0	28,0-31,5	0,10	0,5	-	Al + Ti < 1,5
Ni 6054	NiCr29Fe9	ERNiCrFe-7A	0,04	1,0	7,0-11,0	0,50	0,30	≥52,0	0,12	1,10	1,0	28,0-31,5	0,5	0,50	-	P 0,02 S 0,015
Ni6055	NiCr29F-e5Mo4Nb3	ERNiCrFe-13	0,03	1,0	Bal	0,50	0,30	52,0-62,0	0,10	0,50	0,50	28,0-31,0	2,1-4,0	3,0-5,0	-	P 0,02 S 0,015 B 0,003 Zr 0,02
UNS requested	NiCr30Fe9Nb2		0,04	2,0	7,0-12,0	0,50	0,30	≥54,0	-	0,50	0,50	28,0-31,5	1,0-2,5	0,50	-	-
Ni 6062	NiCr15Fe8Nb	ERNiCrFe-5	0,08	1,0	6,0-10,0	0,3	0,5	≥70,0	-	-	-	14,0-17,0	1,5-3,0	-	-	-
Ni 6176	NiCr16Fe6		0,05	0,5	5,5-7,5	0,5	0,1	≥76,0	0,05	-	-	15,0-17,0	-	-	-	-
Ni 6601	NiCr23Fe15Al	ERNiCrFe-11	0,10	1,0	20,0	0,5	1,0	58,0-63,0	-	1,0-1,7	-	21,0-25,0	-	-	-	-
Ni 6693	NiCr29Fe4Al3	ERNiCrFeAl-1	0,15	1,0	2,5-6,0	0,50	0,50	≥50,0	-	2,5-4,0	1,0	27,0-31,0	0,5-2,5	-	-	P 0,03 S 0,01
Ni 6701	NiCr36Fe7Nb		0,35-0,50	0,5-2,0	7,0	0,5-2,0	-	42,0-48,0	-	-	-	33,0-39,0	0,8-1,8	-	-	-
Ni 6975	NiCr25F-e13Mo6	ERNiCrMo-8	0,03	1,0	10,0-17,0	1,0	0,7-1,2	≥47,0	-	-	0,70-1,5	23,0-2,6	-	5,0-7,0	-	-
Ni 6985	NiCr22Fe20Mo-7Cu2	ERNiCrMo-9	0,01	1,0	18,0-21,0	1,0	1,5-2,5	≥40,0	5,0	-	-	21,0-23,5	0,50	6,0-8,0	1,5	-
Ni 7069	NiCr15Fe7Nb	ERNiCrFe-8	0,08	1,0	5,0-9,0	0,50	0,50	≥70,0	-	0,40-1,0	2,0-2,7	14,0-17,0	0,70-1,20	-	-	-
Ni 7092	NiCr15Ti3Mn	ERNiCrFe-6	0,08	2,0-2,7	8,0	0,3	0,5	≥67,0	-	-	2,5-3,5	14,0-17,0	-	-	-	-
Ni 7718	NiCr19F-e19Nb5M o3	ERNiFeCr-2	0,08	0,3	24,0	0,3	0,3	50,0-55,0	-	0,2-0,8	0,7-1,1	17,0-21,0	4,8-5,5	-	-	B 0,006 P 0,015
Ni 8025	NiFe30Cr29Mo		0,02	1,0-3,0	30,0	0,5	1,5-3,0	35,0-46,0	-	0,2	1,0	27,0-31,0	-	-	-	-
Ni 8065	Ni-Fe30Cr21Mo3	ERNiFeCr-1	0,05	1,0	≥22,0	0,5	1,5-3,0	38,0-46,0	-	0,2	0,60-1,2	19,5-23,5	-	-	-	-
Ni 8125	NiFe26Cr25Mo		0,02	1,0-3,0	30,0	0,5	1,5-3,0	37,0-42,0	-	0,2	1,0	23,0-27,0	-	-	-	-
<b>NICKEL – MOLYBDENUM</b>																
Ni 1001	NiMo28Fe	ERNiMo-1	0,08	1,0	4,0-7,0	1,0	0,50	Min.55,0	2,5	-	-	1,0	-	26,0-30,0	1,0	V 0,20-0,40 S 0,03
Ni 1003	NiMo17Cr7	ERNiMo-2	0,04-0,08	1,0	5,0	1,0	0,50	Min.65,0	0,20	-	-	6,0-8,0	-	15,0-18,0	0,5	V 0,50 S 0,02
Ni 1004	NiMo25Cr5Fe5	ERNiMo-3	0,12	1,0	4,0-7,0	1,0	0,50	Min.62,0	2,5	-	-	4,0-6,0	-	23,0-26,0	1,0	V 0,60 P 0,04 S 0,03
Ni 1008	NiMo19WCr	ERNiMo-8	0,1	1,0	10,0	0,50	0,50	Min.60,0	-	-	-	0,5-3,5	-	18,0-21,0	2,0-4,0	-
Ni 1009	NiMo20WCr	ERNiMo-9	0,10	1,0	5,0	0,50	0,3-1,3	Min.65,0	-	1,0	-	-	-	19,0-22,0	2,0-4,0	-
Ni 1024	NiMo25	ERNiMo-12	0,03	0,80	2,0	0,80	0,50	Min.59,0	1,0	0,50	-	7,0-9,0	-	24,0-26,0	-	P 0,03 S 0,015

## GUIDE TO EN ISO 18274: WIRE AND STRIP ELECTRODES, WIRES AND RODS FOR FUSION WELDING OF NICKEL AND NICKEL ALLOYS

S = solid wire and rod / B = solid strip

ISO 18274	S/B	S Ni 6625	ISO 18274	S/B	S Ni6625 (NiCr22Mo9Nb)
-----------	-----	-----------	-----------	-----	------------------------

Alloy Symbol			C	Mn	Fe	Si	Cu	Ni b	Co b	Al	Ti	Cr	Nb c	Mo	W	Others d) e)
Numerical ISO	Chemical ISO	Numerical AWS	min./max	min./max	min./max	min./max	min./max	min./max	min./max	min./max	min./max	min./max	min./max	min./max	min./max	
<b>NICKEL – MOLYBDENUM</b>																
Ni 1062	NiMo24Cr8Fe6		0,01	1,0	5,0-8,0	0,10	0,50	Min.62,0	-	0,50	-	6,0-10,0	-	21,0-26,0	-	-
Ni 1066	NiMo28	ERNiMo-7	0,02	1,0	2,0	0,10	0,50	Min.64,0	1,0	-	0,50	1,0	-	26,0-30,0	1,0	P 0,04 S 0,03
Ni 1067	NiMo30Cr	ERNiMo-10	0,01	3,0	1,0-3,0	0,10	0,20	Min.65,0	3,0	0,50	0,20	1,0-3,0	0,20	27,0-32,0	3,0	V 0,20 P 0,03
Ni 1069	NiMo28Fe4Cr	ERNiMo-11	0,01	1,0	2,0-5,0	0,10	0,50	Min.65,0	1,0	0,1-0,5	0,30	0,5-1,5	0,50	26,0-30,0	-	-
<b>NICKEL – CHROMIUM – MOLYBDENUM</b>																
(Ni 6007)		ERNiCrMo-1	0,08	1,0	4,0-7,0	1,0	0,5	Rem	2,5	-	-	1,0	-	26,0-30,0	1,0	P 0,025 S 0,03 V 0,20-0,40
(Ni 6002)		ERNiCrMo-2	0,04-0,08	1,0	5,0	1,0	0,5	Rem	0,20	-	-	6,0	-	15,0-18,0	0,5	P 0,015 S 0,02 V 0,50
Ni 6012	NiCr22Mo9		0,05	1,0	3,0	0,5	0,5	Min. 58,0	-	0,4	0,4	20,0 -23,0	1,5	8,0 -10,0	-	-
Ni 6022	NiCr21Mo13Fe4W3	ERNiCrMo-10	0,01	0,5	2,0-6,0	0,08	0,5	Min. 49,0	2,5	-	-	20,0 -22,05	-	12,5-14,5	2,5-3,5	V 0,3
Ni 6035	NiCr33Mo8	ERNiCrMo-22	0,05	0,5	2,0	0,6	0,30	Min. 60,0	1,00	-	-	-	-	-	-	-
Ni 6057	NiCr30Mo11	ERNiCrMo-16	0,02	1,0	2,0	1,0	-	Min. 53,0	-	-	-	29,0-31,0	-	10,0-14,5	-	V 0,4 P 0,04 S 0,03
Ni 6058	NiCr21Mo20	ERNiCrMo-19	0,01	0,5	1,5	0,10	0,50	Min. 52,0	0,3	0,4	-	20,0-23,0	-	19,0-21,0	0,3	N 0,02- 0,15 P 0,015 S 0,01
Ni 6059	NiCr23Mo16	ERNiCrMo-13	0,01	0,5	1,5	0,10	0,5	Min. 56,0	0,3	0,1-0,4	0,5	22,0-24,0	-	15,0-16,5	-	V 0,3
Ni 6200	NiCr23Mo16Cu2	ERNiCrMo-17	0,01	0,5	3,0	0,08	1,3-1,9	Min. 52,0	2,0	0,5	-	22,0-24,0	-	15,0-17,0	-	P 0,25
Ni 6205	NiCr25Mo16	ERNiCrMo-21	0,03	0,5	1,0	0,50,08	0,2	Min. 55,0	0,2	0,4	0,4	24,0-26,0	-	14,0-16,0	0,3	-
Ni 6276	NiCr15Mo16Fe6W4	ERNiCrMo-4	0,02	1,0	0,08	0,08	0,5	Min. 50,0	2,5	-	-	14,5 -16,5	-	15,0-17,0	3,0-4,5	V 0,35 P 0,04 S 0,03
Ni 6452	NiCr20Mo15		0,01	1,0	0,10	0,10	0,5	Min. 56,0	-	-	-	19,0-21,0	0,4	14,0-16,0	-	V 0,4
Ni 6455	NiCr16Mo16Ti	ERNiCrMo-7	0,01	1,0	0,08	0,08	0,5	Min. 56,0	2,0	-	0,7	14,0 -18,0	-	14,0-18,0	0,5	P 0,04 S 0,03
Ni 6625	NiCr22Mo9Nb	ERNiCrMo-3	0,1	0,5	0,5	0,5	0,5	Min. 58,0	-	0,4	0,4	20,0 -23,0	3,2-4,1	8,0-10,0	-	-
Ni 6650	NiCr20Fe14Mo11WN	ERNiCrMo-18	0,03	0,5	0,5	0,5	0,3	Min. 45,0	1,0	0,05-0,50	-	19,0 -21,0	0,05-0,5	9,5-12,5	0,5-2,5	N 0,05- 0,20 S 0,010 V 0,30
Ni 6660	NiCr22Mo10W3	ERNiCrMo-20	0,03	0,5	0,5	0,5	0,3	Min. 58,0	0,2	0,4	0,4	21,0-23,0	0,20	9,5-11,0	2,0-4,0	-
Ni 6686	NiCr21Mo16W4	ERNiCrMo-14	0,01	1,0	0,08	0,08	0,5	Min. 49,0	-	0,5	0,25	19,0 -23,0	-	15,0-17,0	3,0-4,4	S 0,02
Ni 7725	NiCr21Mo8Nb3Ti	ERNiCrMo-15	0,03	0,3	0,20	0,20	-	55,0-59,0	-	0,35	1,0-1,7	19,0 -22,5	2,75-4,0	7,5-9,5	-	-
<b>NICKEL – CHROMIUM – COBALT</b>																
Ni 6160	NiCr28Co30Si3	ERNiCo-CrSi-1	0,02-0,10	1,0	3,5	2,4-3,0	0,5	Min. 30,0	27,0-32,0	0,40	0,20-0,6	26,0-29,0	0,3	0,7	0,5	P0,03
Ni 6617	NiCr22Co12Mo9	ERNiCrCo-Mo-1	0,05-0,15	1,0	3,0	1,0	0,5	Min. 44,0	10,0-15,0	0,8-1,5	0,6	20,0-24,0	-	8,0-10,0	0,5	0,03
Ni 7090	NiCr20Co18Ti3		0,13	1,0	1,5	1,0	0,2	Min. 50,0	15,0-18,0	1,0-2,0	2,0-3,0	18,0-21,0	-	-	-	g
Ni 7263	NiCr20Co20Mo-6Ti2		0,04-0,80	1,0	0,7	0,4	0,2	Min. 47,0	19,0-21,0	0,3-0,6	1,9-2,4	19,0-21,0	-	5,6-6,1	-	Al+Ti 2,4-2,8 f
<b>NICKEL – CHROMIUM – TUNGSTEN</b>																
Ni 6231	NiCr22W14Mo2	ERNiCrW-Mo-1	0,050-0,15	0,3-1,0	3,0	0,25-0,75	0,50	Min.48	5,0	0,2-0,5	--	20,0-24,0	--	1,0-3,0	13,0-15,0	P:0,03
<b>ANY OTHER AGREED COMPOSITION</b>																
	NiZ h															

a) Single values for all elements are maximum except where marked as Min. (minimum).

b) Up to 1 % of the Ni content can be Co unless otherwise specified. For certain applications lower Co levels may be required and should be agreed between contracting parties.

c) Up to 20 % of the Nb content can be Ta.

d) The total of unspecified elements shall not exceed 0,5 %.

e) P 0,020 % maximum and S 0,015 % maximum unless otherwise stated.

f) S ≤ 0,007, Ag ≤ 0,0005, B ≤ 0,005, Bi ≤ 0,0001. g Ag ≤ 0,0005, B ≤ 0,020, Bi ≤ 0,0001, Pb ≤ 0,0020, Zr ≤ 0,15.

g) Ag ≤ 0,0005, B ≤ 0,020, Bi ≤ 0,0001, Pb ≤ 0,0020, Zr ≤ 0,15.

h) Consumables for which the chemical composition is not listed in the table shall

## GUIDE TO EN ISO 18275-A: COVERED ELECTRODES FOR MANUAL METAL ARC WELDING OF HIGH-STRENGTH STEELS

Symbol	Yield Strength min. MPa	Tensile Strength Mpa	Elongation min. %
55	550	610-780	18
62	620	690-890	18
69	690	760-960	17
79	790	880-1080	16
89	890	980-1180	15

PA = Flat position  
 PB = Horizontal-vertical position  
 PC = Transverse position  
 PD = Horizontal overhead position  
 PE = Overhead position  
 PF = Vertical up position  
 PG = Vertical down position

Symbol	Position
1	PA, PB, PC, PD, PE, PF, PG
2	PA, PB, PC, PD, PE, PF
3	PA, PB
4	PA, PB, PG
5	PG, PA, PB

T = Indicates mechanical properties after stress relief treatment.

<b>E</b>	<b>69</b>	<b>6</b>	<b>Mn1Ni</b>	<b>B</b>	<b>3</b>	<b>4</b>	<b>H5</b>	<b>T</b>
----------	-----------	----------	--------------	----------	----------	----------	-----------	----------

E = Covered electrode for manual metal arc

Symbol	Impact Energy Charpy-V Temp °C for 47J min.
Z	No requirements
A	20
0	0
2	-20
3	-30
4	-40
5	-50
6	-60
7	-70
8	-80

Symbol	Coating type
A	Acid
B	Basic
C	Cellulosic
R	Rutile
RR	Rutile (thick coated)
RC	Rutile-Cellulosic
RA	Rutile-Acid
RB	Rutile-Basic

Symbol	Hydrogen content, ml/100 g deposited weld metal, max.
H5	5
H10	10
H15	15

Symbol	Chemical composition of all-weld metal, % *			
	Mn	Ni	Cr	Mo
MnMo		-	-	0.3 - 0.6
Mn1Ni		0.6 - 1.2	-	-
1NiMo	1.4	0.6 - 1.2	-	0.3 - 0.6
1.5NiMo	1.4	1.2 - 1.8	-	0.3 - 0.6
2NiMo	1.4	1.8 - 2.6	-	0.3 - 0.6
Mn1NiMo	1.4 - 2.0	0.6 - 1.2	-	0.3 - 0.6
Mn2NiMo	1.4 - 2.0	1.8 - 2.6	-	0.3 - 0.6
Mn2NiCrMo	1.4 - 2.0	1.8 - 2.6	0.3 - 0.6	0.3 - 0.6
Mn2Ni1CrMo	1.4 - 2.0	1.8 - 2.6	0.6 - 1.0	0.3 - 0.6
Z	Any other agreed composition			

\* If not specified C 0.03-0.10, Ni <0.3, Cr <0.2, Mo <0.2, V <0.05, Nb <0.05, Cu <0.3, P <0.025, S <0.020, Si <0.80.

Single values shown in the table are maximum values.

Symbol	%	Metal recovery %	Type of current
1		<105	AC +DC
2		<105	DC
3		105 <125	AC +DC
4		105 <125	DC
5		125 <160	AC +DC
6		125 <160	DC
7		>160	AC +DC
8		>160	DC



GUIDE TO EN ISO 18275-B: COVERED ELECTRODES FOR MANUAL METAL ARC WELDING OF HIGH-STRENGTH STEELS

E = Covered electrode for manual metal arc

Symbol	Yield Strength min. MPa	Tensile Strength MPa	Elongation min. %
55	550	610-780	18
62	620	690-890	18
69	690	760-960	17
79	790	880-1080	16
89	890	980-1180	15

A = As welded

PA = Flat position  
 PB = Horizontal-vertical position  
 PC = Transverse position  
 PD = Horizontal overhead position  
 PE = Overhead position  
 PF = Vertical up position  
 PG = Vertical down position

Symbol	Position
1	PA, PB, PC, PD, PE, PF, PG
2	PA, PB, PC, PD, PE, PF
3	PA, PB
4	PA, PB, PG
5	PG, PA, PB

**E**      **69**      **18**      **N3M2**      **A**      **H5**

8	Type of covering	Welding positions a	Type of current
10	cellulosic	all	DC(+)
11	cellulosic	all	AC or DC(+)
13	rutile	all b	AC or DC(±)
15	basic	all b	DC (+)
16	basic	all b	AC or DC(+)
18	basic + iron powder	all b	AC or DC(+)
45	basic	all	AC or DC(+)

**NOTE:** A description of the characteristic of each of the types of covering is given in annex C

- a) Positions are defined in ISO 6947. PA = flat, PB =horizontal vertical fillet, PC = horizontal, PG = vertical down
- b) All positions may or may not include vertical down welding. This shall be specified in the manufacturer's trade literature.

AC = ALTERNATING CURRENT  
 DC = DIRECT CURRENT

Alloy symbol	Principal alloy element(s)	Nominal level %
3 M2	Mn	1,5
	Mo	0,4
4 M2	Mn	2,0
	Mo	0,4
3 M3	Mn	1,5
	Mo	0,5
N1M1	Ni	0,5
	Mo	0,2
N2M1	Ni	1,0
	Mo	0,2
N3M1	Ni	1,5
	Mo	0,2
N3M2	Ni	1,5
	Mo	0,4
N4M1	Ni	2,0
	Mo	0,2
N4M2	Ni	2,0
	Mo	0,4
N4M3	Ni	2,0
	Mo	0,5
N5M1	Ni	2,5
	Mo	0,2
N5M4	Ni	2,5
	Mo	0,6
N9M3	Ni	4,5
	Mo	0,5
N13L	Ni	6,5
N3CM1	Ni	1,5
	Cr	0,2
	Mo	0,2
N4C2M1	Ni	1,8
	Cr	0,3
	Mo	0,4
N4C2M2	Ni	2,0
	Cr	1,0
	Mo	0,4
N5CM3	Ni	2,5
	Cr	0,3
	Mo	0,5
N7CM3	Ni	3,5
	Cr	0,3
	Mo	0,5
P1	Mn	1,2
	Ni	1,0
	Mo	0,5
P2	Mn	1,3
	Ni	1,0
	Mo	0,5
G	Any other agreed composition	

## GUIDE TO EN ISO 18276-A: TUBULAR CORED ELECTRODES FOR GAS-SHIELDED AND NON-GAS-SHIELDED METAL ARC WELDING OF HIGH STRENGTH STEELS

T= Tubular cored electrodes	Symbol	Yield Strength min. MPa	Tensile Strength MPa	Elongation min. %	Gases according to ISO 14175	Symbol	Hydrogen content, ml/100 g deposited weld metal, max.
	55	550	610-780	18		H5	5
	62	620	690-890	18		H10	10
	69	690	760-960	17		H15	15
	79	790	880-1080	16			
	89	890	980-1180	15			

<b>T</b>	<b>62</b>	<b>5</b>	<b>Mn1,5Ni</b>	<b>B</b>	<b>M21</b>	<b>1</b>	<b>H5</b>
----------	-----------	----------	----------------	----------	------------	----------	-----------

Symbol	Impact Energy Charpy-V Temp °C for 47J min.
Z	No requirements
A	20
0	0
2	-20
3	-30
4	-40
5	-50
6	-60
7	-70
8	-80

PA = Flat position  
 PB = Horizontal-vertical position  
 PC = Transverse position  
 PD = Horizontal overhead position  
 PE = Overhead position  
 PF = Vertical up position  
 PG = Vertical down position

Symbol	Positions a)
1	PA, PB, PC, PD, PE, PF, PG
2	PA, PB, PC, PD, PE, PF
3	PA, PB
4	PA, PB, PG

a) Positions are defined in ISO 6947.

Symbol	Characteristics	Types of weld	Shielding gas
R	Rutile, slow-freezing slag	Single and multiple pass	Required
P	Rutile, fast-freezing slag	Single and multiple pass	Required
B	Basic	Single and multiple pass	Required
M	Metal powder	Single and multiple pass	Required
Z	Other types		

**NOTE:** A description of the characteristics of each of the types of core is given in Annex C

Symbol	Chemical composition of all-weld metal, % *								
	C	Mn	Si	P	S	Ni	Cr	Mo	V
MnMo	0,03 - 0,10	1.4 - 2.0	0,90	0,020	0,020	0,3	0,2	0.3 - 0.6	0,05
Mn1Ni	0,03 - 0,10	1.4 - 2.0	0,90	0,020	0,020	0.6 - 1.2	0,2	0,2	0,05
Mn1,5Ni	0,03 - 0,10	1,1 - 1,8	0,90	0,020	0,020	1,3 - 1,8	0,2	0,2	0,05
Mn2,5Ni	0,03 - 0,10	1,1 - 2,0	0,90	0,020	0,020	2,1 - 3,0	0,2	0,2	0,05
1NiMo	0,03 - 0,10	1.4	0,90	0,020	0,020	0.6 - 1.2	0,2	0.3 - 0.6	0,05
1.5NiMo	0,03 - 0,10	1.4	0,90	0,020	0,020	1,2 - 1,8	0,2	0.3 - 0.7	0,05
2NiMo	0,03 - 0,10	1.4	0,90	0,020	0,020	1,8 - 2,6	0,2	0.3 - 0.7	0,05
Mn1NiMo	0,03 - 0,10	1.4 - 2.0	0,90	0,020	0,020	0.6 - 1.2	0,2	0.3 - 0.7	0,05
Mn2NiMo	0,03 - 0,10	1.4 - 2.0	0,90	0,020	0,020	1,8 - 2,6	0,2	0.3 - 0.7	0,05
Mn2NiCrMo	0,03 - 0,10	1.4 - 2.0	0,90	0,020	0,020	1,8 - 2,6	0.3 - 0.6	0.3 - 0.6	0,05
Mn2Ni1CrMo	0,03 - 0,10	1.4 - 2.0	0,90	0,020	0,020	1,8 - 2,6	0.6 - 1.0	0.3 - 0.6	0,05

Z Any other agreed composition

a) Single values shown in the table are maximum values.

b) Cu < 0,3, Nb < 0,05

WELDING KNOW-HOW - STANDARD

GUIDE TO EN ISO 18276-B: TUBULAR CORED ELECTRODES FOR GAS-SHIELDED AND NON-GAS-SHIELDED METAL ARC WELDING OF HIGH STRENGTH STEELS

T = Tubular cored electrodes
------------------------------

Symbol	Yield Strength min. MPa	Tensile Strength MPa	Elongation min. %
55	550	610-780	18
62	620	690-890	18
69	690	760-960	17
79	790	880-1080	16
89	890	980-1180	15

Gases acc. to ISO 14175
-------------------------

PA = Flat position  
 PB = Horizontal-vertical position  
 PC = Transverse position  
 PD = Horizontal overhead position  
 PE = Overhead position  
 PF = Vertical up position  
 PG = Vertical down position

Symbol	Hydrogen content, ml/100 g deposited weld metal, max.
H5	5
H10	10
H15	15

Symbol	Positions a
0	PA, PB
1	PA, PB, PC, PD, PE, PF or PG, oder PF + PG

A = As welded

U = indicates that 47J is reached in the welding state at the test temperature

**T 69 5 T5 1 M21 A N3M1 (U)H5**

Composition designation	Chemical composition a) b) c)									
	C	Mn	Si	P	S	Ni	Cr	Mo	V	
3M2	0,12	1,25 - 2,00	0,80	0,030	0,030	-	-	0,25 - 0,55	-	
3M3	0,12	1,00 - 1,75	0,80	0,030	0,030	-	-	0,40 - 0,65	-	
4M2	0,15	1,65 - 2,25	0,80	0,030	0,030	-	-	0,25 - 0,55	-	
Ni1M2	0,15	1,00 - 2,00	0,80	0,030	0,030	0,40 - 1,00	0,20	0,50	0,05	
N2	0,15	1,00 - 2,00	0,80	0,030	0,030	0,50 - 1,50	0,20	0,20	0,05	
N2M1	0,15	2,25	0,80	0,030	0,030	0,40 - 1,50	0,20	0,35	0,05	
N2M2	0,15	2,25	0,80	0,030	0,030	0,40 - 1,50	0,20	0,20 - 0,65	0,05	
N3C1M2	0,10 - 0,25	0,6 - 1,6	0,80	0,030	0,030	0,75 - 2,00	0,20 - 0,70	0,15 - 0,55	0,05	
N3M1	0,15	0,5 - 1,75	0,80	0,030	0,030	1,00 - 2,00	0,15	0,35	0,05	
N3M2	0,15	0,75 - 2,25	0,80	0,030	0,030	1,25 - 2,60	0,15	0,25 - 0,65	0,05	
N4M1	0,12	2,25	0,80	0,030	0,030	1,75 - 2,75	0,20	0,35	0,05	
N4M2	0,15	2,25	0,80	0,030	0,030	1,75 - 2,75	0,20	0,20 - 0,65	0,05	
N4M21	0,12	1,25 - 2,25	0,80	0,030	0,030	1,75 - 2,75	0,20	0,50	-	
N4C1M2	0,15	1,20 - 2,25	0,80	0,030	0,030	1,75 - 2,60	0,20 - 0,65	0,20 - 0,65	0,03	
N4C2M2	0,15	2,25	0,80	0,030	0,030	1,75 - 2,75	0,20 - 0,65	0,20 - 0,65	0,05	
N5M2	0,07	0,5 - 1,5	0,60	0,15	0,15	1,30 - 3,75	0,20	0,50	0,05	
N6C1M4	0,12	2,25	0,80	0,030	0,030	2,50 - 3,50	1,00	0,40 - 1,00	0,05	
Z		< 1,75	<0,80	0,030	0,030	< 0,50	< 0,30	<0,20	< 0,10	

a) Single values shown in the table are maximum values. b) Al<1,8  
 b) Al<1,8

	Shielding gas	Operating polarity	Transfer of droplet	Welding position	Charekteristics	Type of weld
T1	Required	d.c.(+)	Spray type	0 or 1	Low spatter loss, flat to slightly convex bead and high deposition	Single and multiple pass
T5	Required	d.c.(+)	Globular type	0 or 1	Slightly convex bead, a thin slag without completely converging the weld bead, good impact properties and hot and cold crack resistance compared to T1	Single and multiple pass
T7	Not required	d.c.(-)	Small droplet to spray	0 or 1	High deposition rates and excellent resistance to hot cracking	Single and multiple pass
T8	Not required	d.c.(-)	Small droplet to spray	0 or 1	Very good low temperature impact properties	Single and multiple pass
T11	Not required	d.c.(-)	Spray type	0 or 1	Some electrodes are designed for thin plate only. The manufacturer should be consulted regarding any plate thickness limitations.	Single and multiple pass
T15	Required	d.c.(+)	Very fine droplet to spray	0 or 1	Core consisting of metal alloys and iron powder, and minimal slag cover	Single and multiple pass
TG	As agreed between purchaser and supplier					

## GUIDE TO EN ISO 20378-A: RODS FOR GAS WELDING OF NON-ALLOY AND CREEP-RESISTING STEELS

O = Gas welding rods

O

III

Symbol	Chemical composition of all-weld metal , % *									
	C	Si	Mn	P	S	Mo	Ni	Cr	Cu <sub>b</sub>	andere
I	0,03 - 0,12	0,01 - 0,20	0,35 - 0,65	0,030	0,025	0,3	0,3	0,15	0,35	V 0,03
II	0,03 - 0,20	0,05 - 0,25	0,50 - 1,20	0,025	0,025	0,3	0,3	0,15	0,35	V 0,03
III	0,05 - 0,15	0,05 - 0,25	0,95 - 1,25	0,020	0,020	0,3	0,35-0,80	0,15	0,35	V 0,03
IV	0,08 - 0,15	0,10 - 0,25	0,90 - 1,20	0,020	0,020	0,45 - 0,65	0,3	0,15	0,35	V 0,03
V	0,10 - 0,15	0,10 - 0,25	0,80 - 1,20	0,020	0,020	0,45 - 0,65	0,3	0,80 - 1,20	0,35	V 0,03
VI	0,03 - 0,10	0,10 - 0,25	0,40 - 0,70	0,020	0,020	0,90 - 1,20	0,3	2,00 - 2,20	0,35	V 0,03
45	0,08	0,10	0,50	0,035	0,04	0,20	0,30	0,20	0,30	Al 0,02
60	0,15	0,10 - 0,35	0,90 - 1,40	0,035	0,035	0,20	0,30	0,20	0,30	Al 0,02
65	0,15	0,10 - 0,70	0,90 - 1,60	0,035	0,035	0,20	0,30	0,40	0,30	Al 0,02
100	0,18 - 0,23	0,20 - 0,35	0,70 - 0,90	0,025	0,025	0,15 - 0,25	0,40 - 0,70	0,40 - 0,60	0,30	Al 0,02
Z	Any other agreed composition									

a) Single values shown in the table are maximum values.  
b) Cu < 0,3, Nb < 0,05

Welding behaviour of different rods						
Characteristics	Designation of the rod					
	I	II	III	IV	V	VI
Flow characteristics	Low viscosity	Less low viscosity	Tough viscosity			
Spatter	A lot	Few	None			
Porosity	Yes	Yes	None			

## GUIDE TO EN ISO 21952-A/B: WIRES ELECTRODES, WIRES, RODS AND DEPOSITS FOR GAS-SHIELDED ARC WELDING OF CREEP-RESISTING STEELS

W = TIG Tungsten inert gas welding  
G = Gas shielded arc welding

W/G CrMo1Si

W/G 1CM

Chemical composition symbols for classification according to		Chemical composition, % b) c)											
Chemical composition ISO 21952 A	Tensile strength and chemical composition ISO 21952-B	C	Si	Mn	P	S	Ni	Cr	Mo	Cu	Ti	V	Other elements
MoSi	(1M3)	0,08 - 0,15	0,50 - 0,80	0,70 - 1,30	0,020	0,020	--	--	0,40 - 0,60	--	--	--	--
(MoSi)	1M3	0,12	0,30 - 0,70	1,30	0,025	0,025	0,20	--	0,40 - 0,65	0,35	--	--	--
MnMo	--	0,08 - 0,15	0,05 - 0,25	1,30 - 1,70	0,025	0,025	--	--	0,45 - 0,65	--	--	--	--
	3M3	0,12	0,60 - 0,90	1,10 - 1,60	0,025	0,025	--	--	0,40 - 0,65	0,50	--	--	--
	3M3T	0,12	0,40 - 1,00	1,00 - 1,80	0,025	0,025	--	--	0,40 - 0,65	0,50	0,02 - 0,30	--	--
MoVSi		0,06 - 0,15	0,40 - 0,70	0,70 - 1,10	0,020	0,020	--	0,30 - 0,60	0,50 - 1,00	--	--	0,20 - 0,40	--
	(CM)	0,12	0,10 - 0,40	0,20 - 1,00	0,025	0,025	--	0,40 - 0,90	0,40 - 0,65	0,40	--	--	--
	CMT	0,12	0,30 - 0,90	1,00 - 1,80	0,025	0,025	--	0,30 - 0,70	0,40 - 0,65	0,40	0,02 - 0,30	--	--
CrMo1Si	(1CM3)	0,08 - 0,14	0,50 - 0,80	0,80 - 1,20	0,020	0,020	--	0,90 - 1,30	0,40 - 0,65	--	--	--	--
CrMoV1Si	--	0,06 - 0,15	0,50 - 0,80	0,80 - 1,20	0,020	0,020	--	0,90 - 1,30	0,90 - 1,30	--	--	0,10 - 0,35	--
	1CM	0,07 - 0,12	0,40 - 0,70	0,40 - 0,70	0,025	0,025	0,20	1,20 - 1,50	0,40 - 0,65	0,35	--	--	--
	1CM1	0,12	0,20 - 0,50	0,60 - 0,90	0,025	0,025	--	1,00 - 1,60	0,30 - 0,65	0,40	--	--	--
	1CM2	0,05 - 0,15	0,15 - 0,40	1,60 - 2,00	0,025	0,025	--	1,00 - 1,60	0,40 - 0,65	0,40	--	--	--
(CrMoV1Si)	1CM3	0,12	0,30 - 0,90	0,80 - 1,50	0,025	0,025	--	1,00 - 1,60	0,40 - 0,65	0,40	--	--	--
	1CML	0,05	0,40 - 0,70	0,40 - 0,70	0,025	0,025	0,20	1,20 - 1,50	0,40 - 0,65	0,35	--	--	--
	1CML1	0,05	0,20 - 0,80	0,80 - 1,40	0,025	0,025	--	1,00 - 1,60	0,40 - 0,65	0,40	--	--	--
	1CMT	0,05 - 0,15	0,30 - 0,90	0,80 - 1,50	0,025	0,025	--	1,00 - 1,60	0,40 - 0,65	0,40	0,02 - 0,30	--	--
	1CMT1	0,12	0,30 - 0,90	1,20 - 1,90	0,025	0,025	--	1,00 - 1,60	0,40 - 0,65	0,40	0,02 - 0,30	--	--
	2CMWV	0,12	0,10 - 0,70	0,20 - 1,00	0,020	0,010	--	2,00 - 2,60	0,40 - 0,65	0,40	--	0,10 - 0,50	Nb: 0,01 - 0,08 W: 1,00 - 2,00
	2CMWV-Ni	0,12	0,10 - 0,70	0,80 - 1,60	0,020	0,010	0,30 - 1,00	2,00 - 2,60	0,05 - 0,30	0,40	--	0,10 - 0,50	Nb: 0,01 - 0,08 W: 1,00 - 2,00
CrMo2Si	(2C1M3)	0,04 - 0,12	0,50 - 0,80	0,80 - 1,20	0,020	0,020	--	2,3 - 3,0	0,90 - 1,20	--	--	--	--
CrMo2LSi	(2C1ML1)	0,05	0,50 - 0,80	0,80 - 1,20	0,020	0,020	--	2,3 - 3,0	0,90 - 1,20	--	--	--	--
	2C1M	0,07 - 0,12	0,40 - 0,70	0,40 - 0,70	0,025	0,025	0,20	2,30 - 2,70	0,90 - 1,20	0,35	--	--	--
	2C1M1	0,05 - 0,15	0,10 - 0,50	0,30 - 0,60	0,025	0,025	--	2,10 - 2,70	0,85 - 1,20	0,40	--	--	--
	2C1M2	0,05 - 0,15	0,10 - 0,60	0,50 - 1,20	0,025	0,025	--	2,10 - 2,70	0,85 - 1,20	0,40	--	--	--
(CrMo2LSi)	2C1M3	0,12	0,30 - 0,90	0,75 - 1,50	0,025	0,025	--	2,10 - 2,70	0,90 - 1,20	0,40	--	--	--
(CrMo2LSi)	2C1ML	0,05	0,40 - 0,70	0,40 - 0,70	0,025	0,025	0,20	2,30 - 2,70	0,90 - 1,20	0,35	--	--	--
(CrMo2LSi)	2C1ML1	0,05	0,30 - 0,90	0,80 - 1,40	0,025	0,025	--	2,10 - 2,70	0,90 - 1,20	0,40	--	--	--
	2C1MV	0,05 - 0,15	0,10 - 0,50	0,20 - 1,00	0,025	0,025	--	2,10 - 2,70	0,85 - 1,20	0,40	--	0,15 - 0,50	--
	2C1MV1	0,12	0,10 - 0,70	0,80 - 1,60	0,025	0,025	--	2,10 - 2,70	0,90 - 1,20	0,40	--	0,15 - 0,50	--
	2C1MT	0,05 - 0,15	0,35 - 0,80	0,75 - 1,50	0,025	0,025	--	2,10 - 2,70	0,90 - 1,20	0,40	0,02 - 0,30	--	--
	2C1MT1	0,04 - 0,12	0,20 - 0,80	1,60 - 2,30	0,025	0,025	--	2,10 - 2,70	0,90 - 1,20	0,40	0,02 - 0,30	--	--
	3C1M	0,12	0,10 - 0,70	0,50 - 1,20	0,025	0,025	--	2,75 - 3,75	0,90 - 1,20	0,40	--	--	--
	3C1MV	0,05 - 0,15	0,50	0,20 - 1,00	0,025	0,025	--	2,75 - 3,75	0,90 - 1,20	0,40	--	0,15 - 0,50	--
	3C1MV1	0,12	0,10 - 0,70	0,80 - 1,60	0,025	0,025	--	2,75 - 3,75	0,90 - 1,20	0,40	--	0,15 - 0,50	--

## GUIDE TO EN ISO 21952-A/B: WIRES ELECTRODES, WIRES, RODS AND DEPOSITS FOR GAS-SHIELDED ARC WELDING OF CREEP-RESISTING STEELS

W = TIG Tungsten inert gas welding  
G = Gas shielded arc welding

W/G CrMo1Si

W/G 1CM

Chemical composition symbols for classification according to		Chemical composition, % b) c)											
Chemical composition ISO 21952 A	Tensile strength and chemical composition ISO 21952-B	C	Si	Mn	P	S	Ni	Cr	Mo	Cu	Ti	V	Other elements
CrMo5Si	(5CM)	0,03 - 0,10	0,03 - 0,60	0,03 - 0,70	0,025	0,025	--	5,5 - 6,5	0,50 - 0,80	--	--	--	--
(CrMo5Si)	5CM	0,10	0,50	0,40 - 0,70	0,025	0,025	0,60	4,50 - 6,00	0,45 - 0,65	0,35	--	--	--
CrMo9		0,06 - 0,10	0,30 - 0,60	0,30 - 0,70	0,020	0,020	1,0	8,5 - 10,0	0,80 - 1,20	--	--	0,15	--
CrMo9Si	(9C1M)	0,03 - 0,10	0,40 - 0,80	0,40 - 0,80	0,020	0,020	--	8,5 - 10,0	0,80 - 1,20	--	--	--	--
CrMo91		0,07 - 0,15	0,60	0,40 - 1,5	0,020	0,020	0,4 - 1,0	8,0 - 10,5	0,80 - 1,20	0,25	--	0,15 - 0,30	Nb: 0,03 - 0,10 N: 0,02 - 0,07
(CrMo9Si)	9C1M	0,10	0,50	0,40 - 0,70	0,025	0,025	0,50	8,0 - 10,5	0,80 - 1,20	0,35	--	--	--
	9C1MV	0,07 - 0,13	0,15 - 0,50	1,20	0,010	0,010	0,80	8,0 - 10,5	0,85 - 1,20	0,20	--	0,15 - 0,30	Nb: 0,02 - 0,10 Al: 0,04 N: 0,03 - 0,07 Mn + Ni: 1,50
	9C1MV1	0,12	0,50	0,50 - 1,25	0,025	0,025	0,10 - 0,80	8,00 - 10,50	0,80 - 1,20	0,40	--	0,10 - 0,35	Nb: 0,01 - 0,12 N: 0,01 - 0,05
	9C1MV2	0,12	0,10 - 0,60	1,20 - 1,90	0,025	0,025	0,20 - 1,00	8,00 - 10,50	0,80 - 1,20	0,40	--	0,15 - 0,50	Nb: 0,01 - 0,12 N: 0,01 - 0,05
	10CMV	0,05 - 0,15	0,10 - 0,70	0,20 - 1,00	0,025	0,025	0,30 - 1,00	9,00 - 11,50	0,40 - 0,65	0,40	--	0,10 - 0,50	Nb: 0,04 - 0,16 N: 0,02 - 0,07
	10CMWV-Co	0,12	0,10 - 0,70	0,20 - 1,00	0,020	0,020	0,30 - 1,00	9,00 - 11,50	0,20 - 0,55	0,40	--	0,10 - 0,50	Co 0,80 - 1,20 Nb 0,01 - 0,08 W 1,00 - 2,00 N 0,02 - 0,07
	10CMWV-Co1	0,12	0,10 - 0,70	0,80 - 1,50	0,020	0,020	0,30 - 1,00	9,00 - 11,50	0,25 - 0,55	0,40	--	0,10 - 0,50	Co 0,80 - 1,20 Nb 0,01 - 0,08 W 1,00 - 2,00 N 0,02 - 0,07
	10CMWV-Cu	0,05 - 0,15	0,10 - 0,70	0,20 - 1,00	0,020	0,020	0,70 - 1,40	9,00 - 11,50	0,20 - 0,50	1,00 - 2,00	--	0,10 - 0,50	Nb 0,01 - 0,08 W 1,00 - 2,00 N 0,02 - 0,07
CrMoWV12Si		0,17 - 0,24	0,20 - 0,60	0,40 - 1,00	0,025	0,020	0,8	10,5 - 12,0	0,80 - 1,20	--	--	0,20 - 0,40	W 0,35 - 0,80
Z	G	Any other agreed composition											

a) A designation in parentheses [e.g., (CrMo1) or (1CM)] indicates a near match in the other designation system, but not an exact match. The correct designation for a given composition range is the one without parentheses. A given product may, by having a more restricted chemical composition which fulfils both sets of designation requirements, be assigned both designations independently, provided that the mechanical property requirements of Table 2 are also satisfied.

b) Single values shown in the table are maximum values

c) If not specified: Ni < 0,3 %, Cu < 0,3 %, Nb < 0,01 %.

d) Elements listed without specified values shall be reported, if intentionally added. The total of these unspecified elements and all other elements found in the course of routine chemical analysis shall not exceed 0,50 %

e) Compositions with approximately 0.5 % Mo, without Cr and significantly more than 1 % Mn cannot be used for the creep resistant range.

f) Welding consumables for which the chemical composition is not given in the table must be marked in the same way and preceded by the letter Z (ISO 21952-A) or G (ISO 21952-B). Since the ranges of chemical composition are not specified, two additives with the same Z or G classification cannot be interchanged.

## GUIDE TO EN ISO 21952-A/B: WIRES ELECTRODES, WIRES, RODS AND DEPOSITS FOR GAS-SHIELDED ARC WELDING OF CREEP-RESISTING STEELS

W = TIG Tungsten inert gas welding  
G = Gas shielded arc welding

W/G		CrMo1Si		W/G		1CM				
Chemical composition symbols for classification according to		Min. yield	Min. tensile strength	Min elongation	Impact energy J at + 20 °C		Heat treatment of all-weld metal			
Chemical composition ISO 21952-A	Tensile strength and chemical composition ISO 21952-B	MPa	MPa	%	Minimum average from three test specimens	Minimum single value	Preheat and interpass temperature °C	Postweld heat treatment of test assembly		
Chemical composition ISO 21952-A	Tensile strength and chemical composition ISO 21952-B							Temperature °C	Time min	
MoSi	(1M3)	355	510	22	47	38	< 200	--	--	
MnMo	(3M3)	355	510	22	47	38	< 200	--	--	
(MoSi)	X 49X 3M3 X 49X 3M3T	390	490	22	--	--	135 - 165	605 - 635	60	
MoVSi		355	510	18	47	38	200 - 300	690 - 730	60	
(CrMo1Si)	X 55X CM X 55X CMT	470	550	17	--	--	135 - 165	605 - 635	60	
CrMo1Si	(1CM)	355	510	20	47	38	150 - 200	660 - 700	60	
(CrMo1Si)	X 55X 1CM	470	550	17	--	--	135 - 165	605 - 635	60	
(CrMo1Si)	X 55X 1CM1 X 55X 1CM2 X 55X 1CM3 X 55X 1CMT X 55X 1CMT1	470	55	17	--	--	135 - 165	675 - 705	60	
	X 52X 1CML	400	520	17	--	--	135 - 165	605 - 635	60	
	X 52X 1CML1	400	520	17	--	--	135 - 165	675 - 705	60	
	X 52X 2CMWV	400	520	17	--	--	160 - 190	700 - 730	120	
	X 57X 2CMWV-Ni	490	570	15	--	--	160 - 190	700 - 730	120	
CrMoV1Si		435	500	15	24	21	200 - 300	680 - 730	60	
CrMo2Si	(2C1M)	400	500	18	47	38	200 - 300	690 - 750	60	
(CrMo2Si)	X 62X 2C1M X 62X 2C1M1 X 62X 2C1M2 X 62X 2C1M3 X 62X 2C1MT X 62X 2C1MT1	540	620	15	--	--	185 - 215	675 - 705	60	
CrMo2LSi	(2C1ML)	400	500	18	47	38	200 - 300	690 - 750	60	
(CrMo2LSi)	X 55X 2C1ML X 55X 2C1ML1	470	55	15	--	--	185 - 215	675 - 705	60	
	X 55X 2C1MV X 55X 2C1MV1	470	55	15	--	--	185 - 215	675 - 705	60	
	X 62X 3C1M	530	620	15	--	--	185 - 215	675 - 705	60	
	X 62X 3C1MV X 62X 3C1MV1	530	620	15	--	--	185 - 215	675 - 705	60	
(CrMo5Si)	X 55X 5CM	470	550	15	--	--	175 - 235	730 - 760	60	
CrMo5Si	(5CM)	400	590	17	47	38	200 - 300	730 - 760	60	
CrMo9	(9C1M)	435	590	18	34	27	200 - 300	740 - 780	120	
CrMo9Si										
	X 55X 9C1M	470	550	15	--	--	205 - 260	730 - 760	60	
CrMo91	(9C1M)	415	585	17	47	38	250 - 350	750 - 760	120	
	X 62X 9C1MV X 62X 9C1MV1 X 62X 9C1MV2	410	620	15	--	--	205 - 320	745 - 775	120	
	X 62X 10CMWV-Co X 62X 10CMWV-Co1	530	620	15	--	--	205 - 260	725 - 755	480	
	X 69X 10CMWV-Cu	600	690	15	--	--	100 - 200	725 - 755	60	
	X 78X 10CMV	680	780	13	--	--	205 - 260	675 - 705	480	
CrMoWV12Si		550	690	15	34	27	250 - 350 or 400 - 500	740 - 780	≥ 120	
Z	X XXX G	As agreed between purchaser and supplier								

**NOTE:** The temperature in the furnace must not exceed 315 °C when the test piece is inserted. From this holding temperature, the heating rate must not exceed 220 °C/h. At the end of the holding time, the test specimen shall be cooled to a temperature below 315 °C in the furnace at a rate below 195 °C/hr. The specimen may be removed from the furnace at any temperature below 315 °C and cooled to room temperature in still air. High deposition rates and excellent resistance -hot cracking



## GUIDE TO EN ISO 24034: SOLID WIRES AND RODS FOR FUSION WELDING OF TITANIUM AND TITANIUM ALLOYS

S	Ti 6402	(TiAl6V4B)
---	---------	------------

Chemical composition symbols for classification according to				Chemical composition, % b) c)								
Numerical AWS	UNS Number	Numerical ISO	chemical	C	O	N	H	Fe	Al	V	Sn	Other elements
Alloy group 01 (alloys 0100, 0120, 0125 and 0130) consists of commercially pure titanium. The alloys differ only in respect to their oxygen content. In general, higher oxygen results in higher strength, 550 instead of 425 MPa, but lower ductility. These are alpha alloys.												
ERTI-1	R50100	Ti 0100	Ti99,8	0,03	0,03 -0,10	0,012	0,005	0,08	--	--	--	--
ERTI-2	R50120	Ti 0120	Ti99,6	0,03	0,08 -0,16	0,015	0,008	0,12	--	--	--	--
ERTI-3	R50125	Ti 0125	Ti99,5	0,03	0,13 -0,20	0,02	0,008	0,16	--	--	--	--
ERTI-4	R50130	Ti 0130	Ti99,3	0,03	0,18 -0,32	0,025	0,008	0,25	--	--	--	--
Alloy group 22 (alloys 2251, 2253 and 2255) consists of low-oxygen titanium with deliberately small additions of palladium or ruthenium. These elements enhance the corrosion resistance of titanium in reducing acid media, crevice-corrosion situations, and hot oxidizing chloride brines. These are alpha alloys.												
ERTI-11	R52251	Ti 2251	TiPd0,2	0,03	0,03 -0,10	0,012	0,005	0,08	--	--	--	Pd: 0,12 -0,25
ERTI-17	R52253	Ti 2253	TiPd0,06	0,03	0,03 -0,10	0,012	0,005	0,08	--	--	--	Pd: 0,04 -0,08
ERTI-27	R52255	Ti 2255	TiRu0,1	0,03	0,03 -0,10	0,012	0,005	0,08	--	--	--	Ru: 0,08 -0,14
Alloy group 24 (alloys 2401, 2403 and 2405), like Group 22, has deliberately small additions of palladium and ruthenium but consists of a higher oxygen content giving higher strength (500 instead of 425 MPa). These are alpha alloys												
ERTI-7	R52401	Ti 2401	TiPd0,2A	0,03	0,08 -0,16	0,015	0,008	0,12	--	--	--	Pd: 0,12 -0,25
ERTI-16	R52403	Ti 2403	TiPd0,06A	0,03	0,08 -0,16	0,015	0,008	0,12	--	--	--	Pd: 0,04 -0,08
ERTI-27	R52405	Ti 2405	TiRu0,1A	0,03	0,08 -0,16	0,015	0,008	0,12	--	--	--	Ru: 0,08 -0,14
Alloy group 34 (alloys 3401, 3416, 3423, 3443 and 3444) contains about 0,5 % Ni as a deliberate alloying element. Nickel enhances the corrosion resistance of titanium in reducing acid media, crevice-corrosion situations, and hot oxidizing chloride brines. These are alpha alloys.												
ERTI-12	R53401	Ti 3401	TiNi0,7Mo0,3	0,03	0,08 -0,16	0,015	0,008	0,15	--	--	--	Mo: 0,2 -0,4 Ni: 0,6 -0,9
ERTI-15A	R53416	Ti 3416	TiRu0,05Ni0,5	0,03	0,13 -0,20	0,02	0,008	0,16	--	--	--	Ru: 0,04 -0,06 Ni: 0,4 -0,6
ERTI-13	R53423	Ti 3423	TiNi0,5	0,03	0,03 -0,10	0,012	0,005	0,08	--	--	--	Ru: 0,04 -0,06 Ni: 0,4 -0,6
ERTI-14	R53424	Ti 3424	TiNi0,5A	0,03	0,08 -0,16	0,015	0,008	0,12	--	--	--	Ru: 0,04 -0,06 Ni: 0,4 -0,6
ERTI-33	R53443	Ti 3443	TiNi0,45Cr0,15	0,03	0,08 -0,16	0,015	0,008	0,12	--	--	--	Pd: 0,01 -0,02 Ru: 0,02 -0,04 Cr: 0,1 -0,2 Ni: 0,35 -0,55
ERTI-34	R53444	Ti 3444	TiNi0,45Cr0,15A	0,03	0,13 -0,20	0,02	0,008	0,16	--	--	--	Pd: 0,01 -0,02 Ru: 0,02 -0,04 Cr: 0,1 -0,2 Ni: 0,35 -0,55
Alloy group 35 (alloys 3531 and 3533) contains about 0,5 % Co as a deliberate alloying addition. Cobalt enhances the corrosion resistance of titanium in reducing acid media, crevice-corrosion situations, and hot oxidizing chloride brines. These are alpha alloys.												
ERTI-30	R53531	Ti 3531	TiCo0,5	0,03	0,08 -0,16	0,015	0,008	0,12	--	--	--	Pd: 0,04 -0,08 Co: 0,20 -0,80
ERTI-31	R53533	Ti 3533	TiCo0,5A	0,03	0,13 -0,20	0,02	0,008	0,16	--	--	--	Pd: 0,04 -0,08 Co: 0,20 -0,80
Alloy group 46 (alloy 4621) contains about 6 % aluminium, and 2 % tin, and the additions of 4 % zirconium, and 2 % molybdenum allow it to reach ultimate tensile strength of about 1 000 MPa. It is a near alpha alloy.												
AMS 4952	R54621	Ti 4621	TiAl6Zr4Mo2Sn2	0,04	0,30	0,015	0,15	0,05	5,50 -6,50	--	1,80 -2,20	Zr: 3,60 -4,40 Mo: 1,80 -2,20 Cr: 0,25 max
Alloy group 48 (alloy 4810) contains about 8 % aluminium, 1 % vanadium and 1 % molybdenum. This is a near-alpha alloy, having an ultimate tensile strength of around 950 MPa.												
AMS 4955	R54810	Ti 4810	TiAl8V1Mo1	0,08	0,12	0,05	0,01	0,30	7,35 -8,35	0,75 -1,25	--	Mo: 0,75 -1,25
Alloy group 51 (alloy 5112) contains about 5 % aluminium, 1 % vanadium, 1 % tin, 1 % molybdenum and 1 % zirconium. This is an alpha + beta alloy, having an ultimate tensile strength of around 850 MPa.												
ERTI-32	R5112	Ti 5112	TiAl5V1Sn1Mo1Zr1	0,03	0,05 -0,10	0,012	0,008	0,20	4,5 -5,5	0,6 -1,4	0,6 -1,4	Mo: 0,6 -1,2 Zr: 0,6 -1,4 Si: 0,06 -0,14
Alloy group 63 (alloys 6320, 6321, 6324 and 6326) contains about 3 % aluminium and 2,5 % vanadium. These are alpha + beta alloys, having an ultimate tensile strength of around 700 MPa.												
-	-	Ti 6320	TiAl3V2,5	0,03	0,08 -0,16	0,020	0,008	0,25	2,5 -3,5	2,0 -3,0	--	--
ERTI-9	R56321	Ti 6321	TiAl3V2,5A	0,03	0,06 -0,12	0,012	0,005	0,20	2,5 -3,5	2,0 -3,0	--	--
ERTI-28	R56324	Ti 6324	TiAl3V2,5Ru	0,03	0,06 -0,12	0,012	0,005	0,20	2,5 -3,5	2,0 -3,0	--	Ru: 0,08 -0,14
ERTI-18	R56326	Ti 6326	TiAl3V2,5Pd	0,03	0,06 -0,12	0,012	0,005	0,20	2,5 -3,5	2,0 -3,0	--	Pd: 0,04 -0,08
Alloy group 64 (alloys 6400, 6402, 6408, 6414 and 6415) contains about 6 % aluminium and 4 % vanadium. These are alpha + beta alloys, having an ultimate tensile strength of around 1 000 MPa.												
ERTI-5	R56400	Ti 6402	TiAl6V4B	0,05	0,12 -0,20	0,030	0,15	0,22	5,50 -6,75	3,50 -4,50	--	--
ERTI-23	R56408	Ti 6408	TiAl6V4A	0,03	0,03 -0,11	0,012	0,005	0,20	5,5 -6,5	3,5 -4,5	--	--
ERTI-25	R56413	Ti 6413	TiAl6V4Ni0,5Pd	0,05	0,12 -0,20	0,030	0,015	0,22	5,5 -6,7	3,5 -4,5	--	Ni: 0,3 -0,8 Pd: 0,04 -0,08
ERTI-29	R56414	Ti 6414	TiAl6V4Ru	0,03	0,03 -0,11	0,012	0,005	0,20	5,5 -6,5	3,5 -4,5	--	--
ERTI-24	R56415	Ti 6415	TiAl6V4Pd	0,05	0,12 -0,20	0,030	0,015	0,22	5,5 -6,7	3,5 -4,5	--	--
Alloy group 86 (alloys 8441,8641,8646,8211 and 4251) These designation numbers have been proposed for addition to ISO 24034:2005												
ERTI-19	R58641	Ti 8641		0,03	0,06 -0,10	0,015	0,015	0,20	3,0 -4,0	7,5 -8,5	-	Mo:3,5 -4,5 Cr:5,5 -6,5 Zr:3,5 -4,5
ERTI-20	R58646	Ti 8646		0,03	0,06 -0,10	0,015	0,015	0,20	3,0 -4,0	7,5 -8,5	0,04 -0,08	Mo:3,5 -4,5 Cr:5,5 -6,5 Zr:3,5 -4,5
ERTI-21	R58211	Ti 8211		0,03	0,10 -0,15	0,012	0,005	0,20 -0,40	-	-	-	Mo:14,0 -16,0 Nb:2,2 -3,2 Si:0,15 -0,25
ERTI-36	R58451	Ti 8451		0,03	0,06 -0,12	0,02	0,0035	-	-	-	-	Nb: 42,0 -47,0
ERTI-38	R54251	Ti 4251		0,03	0,20 -0,27	0,02	0,010	3,5 -4,5	2,0 -3,0	-	-	--

a) Single values are maxima, unless otherwise noted.

b) The remainder of the alloy is titanium.

c) Analysis of Fe and the interstitial elements C, O, H and N shall be conducted on samples of rod/wire taken after the rod/wire has been reduced to its final diameter and all processing operations have been completed. Analysis of the other elements may be conducted on the same samples, or it may have been conducted on samples taken from the ingot or the rod stock from which the rod/wire is made. In case of dispute, samples from the finished rod/wire shall be the referee method.

d) Residual elements, total, shall not exceed 0,20 %, with no single such element exceeding 0,05 %, except for yttrium, which shall not exceed 0,005 %. Residual elements need not be reported unless a report is specifically required by the purchaser. Residual elements are those elements other than titanium that are not listed in this Table 1 for the particular classification, but which are inherent in the raw material or the manufacturing practice. Residual elements may be present only in trace amounts and they may not be elements that have been intentionally added to the product.

## GUIDE TO EN ISO 24373: SOLID WIRES AND RODS FOR FUSION WELDING OF COPPER AND COPPER ALLOYS

S = Solid wire

<b>S</b>	<b>Cu 6560</b>	<b>( CuSi3Mn1)</b>
----------	----------------	--------------------

Chemical composition symbols for classification according to		Chemical composition, % b) c)																	
numerical	chemical	AWS	UNS	Cu	Al	Fe	Mn	Ni+Co	P	Pb	Si	Sn	Zn	As	C	Ti	S	Others	
<b>COPPER LOW ALLOYED</b>																			
Cu 1897	CuAg1	-	C18970	≥ 99,5+Ag	0,01	0,05	0,2	0,3	0,01-0,05	0,01	0,1	--	--	0,05	--	--	--	0,2 Ag 0,8-1,2	
Cu 1898	CuSn1	ERCu	C18980	≥ 98,0	0,01	--	0,50	--	0,15	0,02	0,5	1,0	--	--	--	--	--	0,50	
Cu 1898A	CuSn1MnSi	-	C18980	rest	0,01	0,03	0,1-0,4	0,1	0,015	0,01	0,1-0,4	0,5-1,0	--	--	--	--	--	0,2	
<b>COPPER-SILICON (SILICON BRONZE)</b>																			
Cu 6511	CuSi2Mn1	-	C65110	rest	0,01	0,1	0,5-1,5	--	0,02	0,02	1,5-2,0	0,1-0,3	0,2	--	--	--	--	0,5	
Cu 6560	CuSi3Mn1	ERCuSi-A	C65600	rest	0,02	0,5	0,5-1,5	--	0,05	0,02	2,8-4,0	0,2	0,4	--	--	--	--	0,5	
Cu 6561	CuSi2Mn1Sn1Zn	-	C65610	rest	--	0,5	1,5	--	--	0,02	2,0-2,8	1,5	1,5	--	--	--	--	0,5	
<b>COPPER TIN (including PHOSPHORAL BRONZE)</b>																			
Cu 5180	CuSn5P	ERCuSn-A	C51800	rest	0,01	--	--	--	0,1-0,4	0,02	--	4,0-6,0	--	--	--	--	--	0,5	
Cu 5180A	CuSn6P	ERCuSn-A	C51800	rest	0,01	0,1	--	--	0,01-0,4	0,02	--	4,0-7,0	--	--	--	--	--	0,2	
Cu 5210	CuSn8P	ERCuSn-C	C52100	rest	--	0,1	--	0,2	0,01-0,4	0,02	--	7,5-8,5	--	--	--	--	--	0,2	
Cu 5211	CuSn10MnSi	-	C52110	rest	0,01	0,1	0,1-0,5	--	0,1	0,02	0,1-0,5	9,0-10,0	--	--	--	--	--	0,5	
Cu 5410	CuSn12P	-	C54100	rest	0,005	--	--	--	0,01-0,4	0,02	--	11,0-13,0	--	--	--	--	--	0,4	
<b>COPPER-ZINC (BRASS)</b>																			
Cu 4641	CuZn40SnSi	-	C45410	58,0-62,0	0,01	0,2	0,3	--	--	0,03	0,1-0,5	1,0	rest	--	--	--	--	0,2	
Cu 4700	CuZn40Sn	RBCuZn-A	C47000	57,0-61,0	0,01 c	c	c	--	--	0,05 c	c	0,25-1,00	rest	--	--	--	--	0,5 c	
Cu 4701	CuZn40SnSiMn	-	C47010	58,5-61,5	0,01	0,25	0,05-0,25	--	--	0,02	0,15-0,40	0,2-0,5	rest	--	--	--	--	0,2	
Cu 6800	CuZn40Ni	RBCuZn-B	C68000	56,0-60,0	0,01 c	0,25-1,20	0,01-0,50	0,2-0,8	--	0,05 c	0,04-0,20	0,8-1,1	rest	--	--	--	--	0,5 c	
Cu 6810	CuZn40Fe1Sn1	RBCuZn-C	C68100	59,0-60,0	0,01 c	0,25-1,20	0,01-0,50	--	--	0,05 c	0,04-0,15	0,8-1,1	rest	--	--	--	--	0,5 c	
Cu 7730	CuZn40Ni10	RBCuZn-D	C77300	46,0-50,0	0,01	--	--	9,0-11,0	0,25	0,05 c	0,04-0,25	--	rest	--	--	--	--	0,5 c	
<b>COPPER-ALUMINIUM (ALUMINIUM BRONZE)</b>																			
Cu 6061	CuAl5Ni2Mn	-	C60510	rest	4,5-5,5	0,5	0,1-1,0	1,0-2,5	--	0,02	0,1	--	0,2	--	--	--	--	0,5	
Cu 6100	CuAl7	ERCuAl-A1	C61000	rest	6,0-8,5	c	0,5	c	--	0,02	0,2	c	0,2	--	--	--	--	0,4 c	
Cu 6180	CuAl10Fe	ERCuAl-A2	C61800	rest	8,5-11,0	1,5	--	--	--	0,02	0,1	--	0,02	--	--	--	--	0,5	
Cu 6240	CuAl11Fe3	ERCuAl-A3	C62400	rest	10,0-11,5	2,0-4,5	--	--	--	0,02	0,1	--	0,1	--	--	--	--	0,5	
Cu 6325	CuAl8Fe4Mn2Ni2	-	C63250	rest	7,0-9,0	1,8-5,0	0,5-3,0	0,5-3,0	--	0,02	0,1	--	0,1	--	--	--	--	0,4	
Cu 6327	CuAl8Ni2Fe2Mn2	-	C63270	rest	7,0-9,5	0,5-2,5	0,5-2,5	0,5-3,0	--	0,02	0,2	--	0,2	--	--	--	--	0,4	
Cu 6328	CuAl9Ni5Fe3Mn2	ERCuNiAl	C63280	rest	8,5-9,5	3,0-5,0	0,6-3,5	4,0-5,5	--	0,02	0,1	--	0,1	--	--	--	--	0,5	
<b>COPPER MANGANESE</b>																			
Cu 6338	CuMn13Al8Fe3Ni2	ERCuMnNiAl	C63380	rest	7,0-8,5	2,0-4,0	11,0-14,0	1,5-3,0	--	0,02	0,1	--	0,15	--	--	--	--	0,5	
<b>COPPER NICKEL</b>																			
Cu 7061	CuNi10	-	C70610	rest	--	0,5-2,0	0,5-1,5	9,0-11,0	0,02	0,02	0,2	--	--	--	0,05	0,1-0,5	0,02	0,4	
Cu 7158	CuNi30Mn1FeTi	ERCuNi	C71581	rest	--	0,4-0,7	0,5-1,5	29,0-32,0	0,02	0,02	0,25	--	--	--	0,04	0,2-0,5	0,01	0,5	

a) The elements for which specific values are given in this table shall be analyzed. However, if the analysis carried out in accordance with the rules provides evidence of the presence of other elements, the table shall be replaced by an additional analysis to show that the sum of these other elements does not exceed the declared maximum level.

b) Single values are maxima, unless otherwise noted.

c) The sum of all other elements, including those for which a maximum value or an asterisk is indicated, shall not exceed the value indicated in „Other sum“

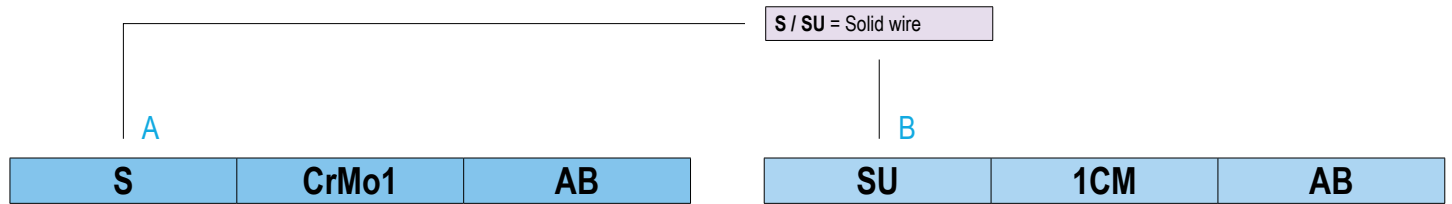
GUIDE TO EN ISO 24598-**A/B**: SOLID WIRE ELECTRODES, TUBULAR CORED ELECTRODES AND ELECTRODE-FLUX COMBINATIONS FOR SUBMERGED ARC WELDING OF CREEP-RESISTING STEELS

Requirements for the chemical composition of solid wire electrodes												
Chemical composition symbols for classification according to		Chemical composition, % b) c)										
Chemical composition ISO 21952 A	Tensile strength and chemical composition ISO 21952-B	C	Si	Mn	P	S	Cr	Ni	Mo	Cu	V	Other elements
Mo	(1M3)	0,08 - 0,15	0,05 - 0,25	0,80 - 1,20	0,025	0,025	0,2	0,3	0,45 - 0,65	0,30	0,03	Nb:001
(Mo)	1M3	0,05 - 0,15	0,20	0,65 - 1,00	0,025	0,025	-	-	0,45 - 0,65	0,35	-	-
	3M3	0,05 - 0,17	0,20	0,95 - 1,35	0,025	0,025	-	-	0,45 - 0,65	0,35	-	-
MnMo	(3M31)	0,08 - 0,15	0,05 - 0,25	1,30 - 1,70	0,025	0,025	0,2	0,3	0,45 - 0,65	0,30	0,03	Nb:001
(MnMo)	3M31	0,18	0,60	1,10 - 1,90	0,025	0,025	-	-	0,30 - 0,70	0,35	-	-
	4M3	0,05 - 0,17	0,20	1,65 - 2,20	0,025	0,025	-	-	0,45 - 0,65	0,35	-	-
	4M31	0,18	0,60	1,70 - 2,60	0,025	0,025	-	-	0,30 - 0,70	0,35	-	-
MoV		0,08 - 0,15	0,10 - 0,30	0,60 - 1,00	0,025	0,025	0,30 - 0,60	0,30	0,50 - 1,00	0,30	0,25 - 0,45	Nb:001
	CM	0,10	0,05 - 0,30	0,40 - 0,80	0,025	0,025	0,40 - 0,75	-	0,45 - 0,65	0,35	-	-
	CM1	0,15	0,40	0,30 - 1,20	0,025	0,025	0,30 - 0,70	-	0,30 - 0,70	0,35	-	-
	C1MH	0,15 - 0,23	0,40 - 0,60	0,40 - 0,70	0,025	0,025	0,45 - 0,65	-	0,90 - 1,20	0,30	-	-
CrMo1	(1CM)/(1CM1)	0,08 - 0,15	0,05 - 0,25	0,60 - 1,00	0,020	0,020	0,90 - 1,30	0,30	0,40 - 0,65	0,3	0,03	Nb:001
(CrMo1)	1CM	0,07 - 0,15	0,05 - 0,30	0,45 - 1,00	0,025	0,025	1,00 - 1,75	-	0,45 - 0,65	0,35	-	-
(CrMo1)	1CM1	0,15	0,60	0,30 - 1,20	0,025	0,025	0,80 - 1,80	-	0,40 - 0,65	0,35	-	-
	1CMVH	0,28 - 0,33	0,55 - 0,75	0,45 - 0,65	0,015	0,015	1,00 - 1,50	-	0,40 - 0,65	0,30	0,20 - 0,30	-
CrMoV1		0,08 - 0,15	0,05 - 0,25	0,80 - 1,20	0,020	0,020	0,90 - 1,30	0,30	0,90 - 1,30	0,3	0,10 - 0,35	Nb:001
CrMo2	(2C1M)	0,08 - 0,15	0,05 - 0,25	0,30 - 0,70	0,020	0,020	2,2 - 2,8	0,30	0,90 - 1,15	0,3	0,03	Nb:001
(CrMo2)	2C1M	0,05 - 0,15	0,05 - 0,30	0,40 - 0,80	0,025	0,025	2,25 - 3,00	-	0,90 - 1,10	0,35	-	-
(CrMo2)	2C1M1	0,15	0,35	0,30 - 1,20	0,025	0,025	2,20 - 2,80	-	0,90 - 1,20	0,35	-	-
(CrMo2)	2C1M2	0,08 - 0,18	0,35	0,30 - 1,20	0,025	0,025	2,20 - 2,80	-	0,90 - 1,20	0,35	-	-
CrMo2Mn	(2C1M) (2C1M1)	0,10	0,50	0,50 - 1,20	0,020	0,015	2,0 - 2,5	0,3	0,90 - 1,20	0,3	0,03	Nb:001
CrMo2L		0,05	0,05 - 0,25	0,30 - 0,70	0,020	0,020	2,2 - 2,8	0,3	0,90 - 1,15	0,3	0,03	Nb:001
	2C1MV	0,05 - 0,15	0,40	0,05 - 1,50	0,025	0,025	2,20 - 2,80	-	0,90 - 1,20	0,35	0,15 - 0,45	Nb:001-0,10
	2CM	0,12	0,80	1,20	0,030	0,030	1,75 - 2,25	-	0,40 - 0,65	0,35	-	-
	3C2WV	0,05 - 0,12	0,50	1,10	0,015	0,015	1,9 - 3,0	0,50	0,50	0,10	0,15 - 0,30	W: 1,50-2,00 Nb: 0,02-0,10 B: 0,006 Al: 0,04 N: 0,05

GUIDE TO EN ISO 24598-**A/B**: SOLID WIRE ELECTRODES, TUBULAR CORED ELECTRODES AND ELECTRODE-FLUX COMBINATIONS FOR SUBMERGED ARC WELDING OF CREEP-RESISTING STEELS

A			B		
<b>S</b>	<b>CrMo1</b>	<b>AB</b>	<b>SU</b>	<b>1CM</b>	<b>AB</b>

S / SU = Solid wire  
T / TU = Cored wire

Requirements for the chemical composition of solid wire electrodes												
Chemical composition symbols for classification according to		Chemical composition, % b) c)										
Chemical composition ISO 21952 A	Tensile strength and chemical composition ISO 21952-B	C	Si	Mn	P	S	Cr	Ni	Mo	Cu	V	Other elements
	3C1MV	0,04 - 0,12	0,05	1,00	0,020	0,15	1,90 - 3,0	0,30	0,80 - 1,20	0,10	0,15 - 0,30	Nb:0,02-0,10 Ti :0,10 B: 0,006 Al: 0,04 N :0,07
(CrMo5)	5CM	0,10	0,05 - 0,50	0,35 - 0,70	0,025	0,025	4,50 - 6,50	-	0,45 - 0,70	0,35	-	-
(CrMo5)	5CM1	0,15	0,60	0,30 - 1,20	0,025	0,025	4,50 - 6,00	-	0,40 - 0,65	0,35	-	-
CrMo5	(5CM) ( 5CM1)	0,03 - 0,10	0,20 - 0,50	0,40 - 0,75	0,020	0,020	5,5 - 6,5	0,30	0,50 - 0,80	0,3	0,03	Nb:0,01
	5CMH	0,25 - 0,40	0,25 - 0,50	0,75 - 1,00	0,025	0,025	4,80 - 6,00	-	0,45 - 0,65	0,35	-	-
CrMo9	(9C1M)	0,06 - 0,10	0,30 - 0,60	0,75 - 1,00	0,025	0,025	8,5 - 10,0	1,0	0,80 - 1,20	0,3	1,5	Nb:0,01
(CrMo9)	9C1M	0,10	0,05 - 0,50	0,30 - 0,65	0,025	0,025	8,0 - 10,5	-	0,80 - 1,20	0,35	-	-
CrMo91	(9C1MV)	0,07 - 0,15	0,60	0,40 - 1,50	0,020	0,020	8,0 - 10,5	0,4-1,0		0,25	0,15 - 0,30	Nb:0,03 -0,10 N:0,02 - 0,07
	9C1MV	0,07 - 0,13	0,50	1,25	0,010	0,010	8,5 - 10,5	1,00	0,85 - 1,15	0,10	0,15 - 0,25	Nb:0,02 -0,10 N:0,03 - 0,07 Al:0,04
	9C1MV1	0,12	0,50	0,50 - 1,25	0,025	0,025	8,00 - 10,5	0,10-0,80	0,80 - 1,20	0,35	0,10 - 0,35	Nb:0,01 -0,12 N:0,01 - 0,05
	9C1MV2	0,12	0,50	1,20 - 1,90	0,025	0,025	8,00 - 10,50	0,20-1,00	0,80 - 1,20	0,35	0,15 -0,50	Nb:0,01 -0,12 N:0,01 - 0,05
CrMoWV12												W:0,035 Nb:0,01
Z	G	Any other analysis that can be verified										

a) A bracketed designation, e.g. (CrMo1) or (1CM), indicates an approximate but not complete match in the other designation system. The correct designation for the range of a given composition is written without parentheses. Due to a restricted chemical composition that meets the requirements according to the designation for both types of classification, a given product may bear both designations if the requirements for mechanical properties according to Tables 1A, 1B and 2B are also met

b) Individual values in the table are maximum values.

c) The wire electrode must be analyzed for those elements for which values are given in the table. If, in the course of the analysis, it is found that other elements are present, their content must be determined to ensure that their total sum (excluding iron) does not exceed 0.50 %.

d) The additional letter „R“ indicates, as a free-standing designation, that the following limit values apply instead of the specifications in the table: S: 0.010%; P: 0.010%; Cu: 0.15%; As: 0.005%; Sn: 0.005%; Sb: 0.005%

e) A ratio of Mn/Si greater than 2.0 shall be aimed for

f) Mn + Ni = not more than 1.50%.

g) Compositions containing approximately 0.5% Mo, no Cr and significantly more than 1% Mn may not be suitable for the creep resistant range.

### Supplementary Info: COMPARISON OF SOLID ELECTRODE DESIGNATIONS

AWS, A5.23/A5.23M Classification	ISO 14171		ISO 24598		ISO 26304	
	ISO 14171-A	ISO 14171-B	ISO 24598-A	ISO 24598-B	ISO 26304-A	ISO 26304-B
EA1	-	SU1M3	(SMo)	SU1M3	-	-
EA1TiB	-	-	-	-	-	-
EA2	S2Mo	SU2M3	SMo	SU2M3	-	-
EA3	S4Mo	SU4M3	-	SU4M3	-	-
EA3K	-	SU4M31	-	SU4M32	-	-
EA4	S3Mo	SU3M3	SMnMo	SU3M3	-	-
EB1	-	-	-	SUCM	-	-
EB2g	-	-	SCrMo1	SU1CM	-	-
EB2H	-	-	-	Su1CMVH	-	-
EB3g	-	-	SCrMo2	SU2C1M	-	-
EB5	-	-	-	SUC1MH	-	-
EB6	-	-	SCrMo5	SU5CM	-	-
EB6H	-	-	-	SU5CMH	-	-
EB8	-	-	SCrMo9	SU9C1M	-	-
EB9	-	-	-	SU9C1MV	-	-

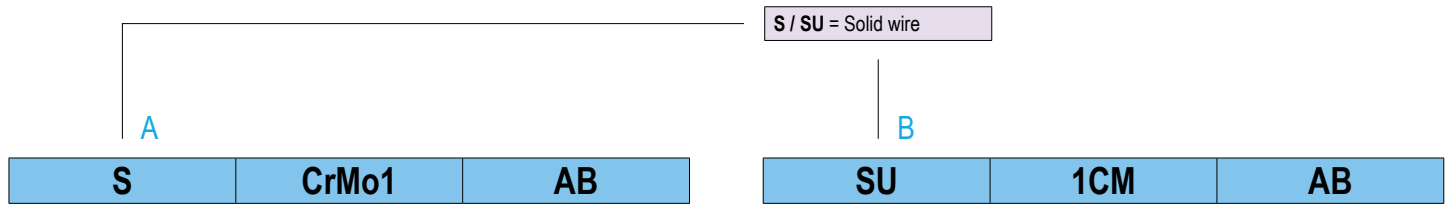
GUIDE TO EN ISO 24598-**A/B**: SOLID WIRE ELECTRODES, TUBULAR CORED ELECTRODES AND ELECTRODE-FLUX COMBINATIONS FOR SUBMERGED ARC WELDING OF CREEP-RESISTING STEELS

Requirements on the chemical composition of the pure weld metal												
Chemical composition symbola for classification according to		Chemical composition, % b)										
Chemical composition ISO 21952 A	Tensile strength and chemical composition ISO 21952-B	C	Si	Mn	P	S	Cr	Ni	Mo	Cu	V	Other elements
Mo	(1M3)	0,15	0,8	1,40	0,030	0,030	0,2	0,3	0,40 - 0,65	0,35	0,03	Nb: 0,01
(Mo)	1M3	0,12	0,8	1,00	0,030	0,030	--	--	0,40 - 0,65	0,35	--	--
	3M3											
MnMo	(3M31)	0,15	0,8	2,0	0,030	0,030	0,2	0,3	0,40 - 0,65	0,35	0,03	Nb: 0,01
(MnMo)	3M31	0,15	0,8	1,6	0,030	0,030	--	--	0,40 - 0,65	0,35	--	--
	4M3 / 4M31	0,15	0,8	2,10	0,030	0,030	--	--	0,40 - 0,65	0,35	--	--
MoV		0,15	0,8	1,4	0,030	0,030	0,20 - 0,60	0,3	0,45 - 1,00	0,35	0,20 - 0,45	Nb: 0,01
	CM / CM1	0,12	0,8	1,60	0,030	0,030	0,40 - 0,65	--	0,40 - 0,65	0,35	--	--
	C1MH	0,18	0,8	1,20	0,030	0,030	0,40 - 0,65	--	0,90 - 1,20	0,35	--	--
CrMo1	(1CM) (1CM1) (1CM2)	0,15	0,8	1,20	0,030	0,030	0,60 - 1,30	0,25	0,35 - 0,65	0,40	0,03	Nb: 0,01
(CrMo1)	1CM / 1CM1	0,05 - 0,15	0,8	1,20	0,030	0,030	1,00 - 1,50	--	0,40 - 0,65	0,35	--	--
	1CMVH	0,10 - 0,25	0,8	1,20	0,020	0,020	1,00 - 1,50	--	0,40 - 0,65	0,35	0,30	--
CrMoV1	--	0,15	0,8	1,40	0,030	0,030	0,80 - 1,30	0,30	0,80 - 1,30	0,35	0,10 - 0,35	Nb: 0,01
CrMo2	(2C1M)	0,15	0,8	1,20	0,030	0,030	2,0 - 2,8	0,30	0,80 - 1,50	0,35	0,03	Nb: 0,01
(CrMo2)	2C1M	0,05 - 0,15	0,8	1,20	0,030	0,030	2,00 - 2,50	--	0,90 - 1,20	0,35	--	--
(CrMo2Mn)	2C1M1 2C1M2											
CrMo2Mn	(2C1M) (2C1M1)	0,10	0,8	1,40	0,030	0,030	1,80 - 2,50	0,30	0,80 - 1,20	0,35	0,03	Nb: 0,01
CrMo2L		0,05	0,8	1,20	0,030	0,030	2,00 - 2,80	0,30	0,80 - 1,15	0,35	0,03	Nb: 0,01
	2C1MV	0,05 - 0,15	0,8	1,30	0,030	0,030	2,00 - 2,60	--	0,90 - 1,20	0,35	0,40	Nb: 0,01 - 0,10
	2CM											
	3C2WV											
	3C1MV											
(CrMo5)	5CM / 5CM1	0,12	0,8	1,20	0,030	0,030	4,50 - 6,00	--	0,40 - 0,65	0,35	--	--
CrMo5	(5CM) (5CM1)	0,10	0,8	1,20	0,030	0,030	4,50 - 6,50	0,30	0,45 - 0,80	0,35	0,03	Nb: 0,01
	5CMH	0,10 - 0,25	0,8	1,20	0,030	0,030	4,50 - 6,00	---	0,40 - 0,65	0,35	--	--
CrMo9	(9C1M)	0,10	0,8	1,20	0,030	0,030	8,00 - 10,0	1,0	0,70 - 1,20	0,35	0,15	Nb: 0,01
(CrMo9)	9C1M	0,12	0,80	1,20	0,030	0,030	8,00 - 10,00	--	0,80 - 1,20	0,35	--	--
CrMo91	(9C1MV)	0,15	0,80	1,30	0,030	0,030	8,00 - 10,50	1,0	0,70 - 1,20	0,35	0,10 - 0,30	Nb: 0,03-0,10 N: 0,02 - 0,07
	9C1MV	0,07 - 0,13	0,15 - 0,30	1,20	0,010	0,010	8,00 - 9,50	0,80	0,80 - 1,10	0,10	0,15 - 0,25	Nb: 0,02-0,10 N: 0,02 - 0,07 Al: 0,04
	9C1MV1	0,12	0,60	1,25	0,030	0,030	8,00 - 10,50	1,00	0,80 - 1,20	0,35	0,10 - 0,50	Nb: 0,01 - 0,12 N: 0,01 - 0,05
	9C1MV2	0,1,2	0,60	1,25 - 2,00	0,030	0,030	8,00 - 10,50	1,00	0,80 - 1,20	0,35	0,10 - 0,50	Nb: 0,01 - 0,12 N: 0,01 - 0,05
CrMoWV12Si		0,24	0,80	1,4	0,030	0,030	9,50 - 12,0	0,80	0,70 - 1,20	0,35	0,15 - 0,40	W: 0,35 - 0,80 Nb: 0,01
Z	G	Any other analysis that can be verified										

a) A designation in parentheses [e.g. (CrMo1) or (1CM)] indicates an approximate match in the other designation system, but not an exact match. The correct designation for a given composition range is the one without brackets. A particular product may be assigned both designations independently by a more restricted chemical composition that meets both designation sets, provided that the mechanical property requirements of Table 2 are also met.

b) The individual values given in the table are maximum values.

GUIDE TO EN ISO 24598-**AB**: SOLID WIRE ELECTRODES, TUBULAR CORED ELECTRODES AND ELECTRODE-FLUX COMBINATIONS FOR SUBMERGED ARC WELDING OF CREEP-RESISTING STEELS

S / SU = Solid wire  
T / TU = Tubular cored wire

A

B

<b>S</b>	<b>CrMo1</b>	<b>AB</b>
----------	--------------	-----------

<b>S</b>	<b>55</b>	<b>4</b>	<b>AB</b>	<b>SU / TU</b>	<b>1CM</b>
----------	-----------	----------	-----------	----------------	------------

Mechanical properties of the pure weld metal (Classification according to chemical composition)								
Chemical composition	Min. yield strength	Min. tensile strength	Minimum elongation	Impact energy J at + 20 °C		Heat treatment of all-weld metal		
				Minimum average from three test specimens	Minimum single value	Preheat and interpass temperature °C	Postweld heat treatment of test assembly	
	MPa	MPa	%				Temperature °C	Time min
MoSi / MnMo	355	510	22	47	38	< 200	--	--
MoV	355	510	18	47	38	200 - 300	690 - 730	60
CrMo1	355	510	20	47	38	150 - 200	660 - 700	60
CrMoV1	435	500	15	24	21	200 - 300	680 - 730	60
CrMo2 / CrMoMn	400	500	18	47	38	200 - 300	690 - 750	60
CrMo2L	400	500	18	47	38	200 - 300	690 - 750	60
CrMo5	400	590	17	47	38	200 - 300	730 - 760	60
CrMo9	435	590	18	34	27	200 - 300	740 - 780	120
CrMo91	415	585	17	47	38	250 - 350	750 - 760	120
CrMoWV12	550	690	15	34	27	250 - 350 or 400 - 500	740 - 780	≥ 120
Z	As agreed between purchaser and supplier							

Type of flux	Symbol
Manganese-silicate	MS
Calcium-silicate	CS
Calcium-magnesium oxides	CG
Calcium-magnesium basic oxides	CB
Calcium-magnesium oxides with iron	CI
Calcium-magnesium basic oxides with iron	IB
Zirconium-silicate	ZS
Rutile-silicate	RS
Alumina-rutile	AR
Alumina-basic	AB
Alumina-silicate	AS
Alumina-fluoride-basic	AF
Fluoride-basic	FB
Any other composition	Z

Symbol	Impact Energy Charpy-V Temp °C for 27J min.
Z	No requirements
Y	20
0	0
2	-20
3	-30
4	-40

Symbol	Minimum yield strength a)	Tensile strength	Minimum elongation b)
	MPa	MPa	%
49	400	490 - 660	20
55	470	550 - 700	18
62	540	620 - 760	15
69	610	690 - 830	14

For yield strength, the 0,2 % proof strength (Rp0,2) is used.

Chemical composition	Preheat and interpass temperature °C	Postweld heat treatment of test assembly	
		Temperature °C	Time min
1M3	150 ± 15	620 ± 15	60 +15 / -0
2M3	150 ± 15	620 ± 15	60 +15 / -0
2M31	150 ± 15	620 ± 15	60 +15 / -0
3M3	150 ± 15	620 ± 15	60 +15 / -0
3M31	150 ± 15	620 ± 15	60 +15 / -0
4M3	150 ± 15	620 ± 15	60 +15 / -0
4M31	150 ± 15	620 ± 15	60 +15 / -0
4M32	150 ± 15	620 ± 15	60 +15 / -0
CM	150 ± 15	620 ± 15	60 +15 / -0
CM1	150 ± 15	620 ± 15	60 +15 / -0
C1MH	150 ± 15	620 ± 15	60 +15 / -0
1CM	150 ± 15	690 ± 15	60 +15 / -0
1CM1	150 ± 15	690 ± 15	60 +15 / -0
1CMVH	150 ± 15	690 ± 15	60 +15 / -0
2C1M	205 ± 15	690 ± 15	60 +15 / -0
2C1M1	205 ± 15	690 ± 15	60 +15 / -0
2C1M2	205 ± 15	690 ± 15	60 +15 / -0
2C1MV	205 ± 15	690 ± 15	60 +15 / -0
5CM	205 ± 15	745 ± 15	60 +15 / -0
5CM1	205 ± 15	745 ± 15	60 +15 / -0
5CMH	205 ± 15	745 ± 15	60 +15 / -0
9C1M	205 ± 15	745 ± 15	60 +15 / -0
9C1MV	205-320	760± 15	120 +15 / -0
9C1MV1	205 ± 15	745 ± 15	60 +15 / -0
9C1MV2	205 ± 15	745 ± 15	60 +15 / -0

## GUIDE TO EN ISO 26304-A/B: SOLID WIRE ELECTRODES, TUBULAR CORED ELECTRODES AND ELECTRODE-FLUX COMBINATIONS FOR SUBMERGED ARC WELDING OF HIGH STRENGTH STEELS

Symbol	Yield Strength min. MPa	Tensile Strength MPa	Elongation min. %
55	550	610-780	18
62	620	690-890	18
69	690	760-960	17
79	790	880-1080	16
89	890	980-1180	15

Symbol	Yield Strength min. MPa	Tensile Strength MPa	Elongation min. %
59X	490	590-790	16
62X	500	620-820	15
69X	550	690-890	14
76X	670	760-960	13
78X	670	780-980	13
83X	740	830-1030	12

**S** = SAW welding

<b>A</b>	<b>S</b>	<b>69</b>	<b>4</b>	<b>AB</b>	<b>(T)2Ni2Mo</b>	<b>H5</b>
<b>B</b>	<b>S</b>	<b>69A</b>	<b>4</b>	<b>AB</b>	<b>(T)SUN2M2</b>	<b>H5</b>

Symbol	Impact Energy Charpy-V Temp °C for 47J min.
Z	No requirements
A	20
0	0
2	-20
3	-30
4	-40
5	-50
6	-60

with mechanical tests performed after post weld heat treatment (P) at the end

Type of flux	Symbol
Manganese-silicate	MS
Calcium-silicate	CS
Calcium-magnesium oxides	CG
Calcium-magnesium basic oxides	CB
Calcium-magnesium oxides with iron	CI
Calcium-magnesium basic oxides with iron	IB
Zirconium-silicate	ZS
Rutile-silicate	RS
Alumina-rutile	AR
Alumina-basic	AB
Alumina-silicate	AS
Alumina-fluoride-basic	AF
Fluoride-basic	FB
Any other composition	Z

Symbol	Hydrogen content, ml/100 g deposited weld metal, max.
H5	5
H10	10
H15	15

**S** = Solid wire  
**T** = Cored wire

## Chemical composition requirements for solid wire electrodes part 1

Symbol for chemical composition		Chemical composition, % b) c)										
ISO 26304-A, Classification by yield strength and 47 J impact energy	ISO 26304-B, Classification by tensile strength and 27 J impact energy	C	Si	Mn	P	S	Cr	Ni	Mo	Cu	V	Other elements
	SUN1M3 c, d	0,10 -0,18	0,20	1,70 -2,40	0,025	0,025	--	0,40 -0,80	0,40 -0,65	0,35	--	--
	SUN2M1 c, d	0,12	0,05 -0,30	1,20 -1,60	0,020	0,020	0,20	0,75 -1,25	0,10 -0,30	0,35	--	--
	SUN2M3 c, d	0,15	0,25	0,80 -1,40	0,020	0,020	0,20	0,80 -1,20	0,40 -0,65	0,40	--	--
	SUN2M31 c, d	0,15	0,25	1,30 -1,90	0,020	0,020	0,20	0,80 -1,20	0,40 -0,65	0,40	--	--
	SUN2M32 c, d	0,15	0,25	1,60 -2,30	0,020	0,020	0,20	0,80 -1,20	0,40 -0,65	0,40	--	--
	SUN2M33 c, d	0,10 -0,18	0,30	1,70 -2,40	0,025	0,025	--	0,70 -1,10	0,40 -0,65	0,35	--	--
S2Ni1Mo d, e	(SUN2M2)	0,07 -0,15	0,05 -0,25	0,80 -1,30	0,020	0,020	0,20	0,80 -1,20	0,40 -0,65	0,30	--	0,50
S3Ni1Mo d, e	(SUN2M2)	0,07 -0,15	0,05 -0,35	1,30 -1,80	0,020	0,020	0,20	0,80 -1,20	0,40 -0,65	0,30	--	0,50
(S2Ni1Mo, S3Ni1Mo)	SUN2M2 c	0,07 -0,15	0,15 -0,35	0,90 -1,70	0,025	0,025	--	0,95 -1,60	0,25 -0,55	0,35	--	--
S3Ni1,5Mo d, e	SUN3M2 c	0,07 -0,15	0,05 -0,25	1,20 -1,80	0,020	0,020	0,20	1,20 -1,80	0,30 -0,50	0,30	--	0,50
	SUN3M2 c	0,10	0,20 -0,60	1,25 -1,80	0,010	0,015	0,30	1,40 -2,10	0,25 -0,55	0,25	--	Ti: 0,10 Zr: 0,10 Al: 0,10
	SUN3M3 c, d	0,15	0,25	0,80 -1,40	0,020	0,020	0,20	1,20 -1,80	0,40 -0,65	0,40	--	--
	SUN3M31 c, d	0,15	0,25	1,30 -1,90	0,020	0,020	0,20	1,20 -1,80	0,40 -0,65	--	--	--
	SUN4M1 c, d	0,12 -0,19	0,10 -0,30	0,60 -1,00	--	--	0,20	1,60 -2,10	0,10 -0,30	0,35	--	--
	SUN4M3 c	0,15	0,25	1,30 -1,90	--	--	--	1,80 -2,40	0,40 -0,65	0,40	--	--
	SUN4M31 c	0,15	0,25	1,60 -2,30	--	--	--	1,80 -2,40	0,40 -0,65	0,40	--	--
	SUN4M2 c	0,10	0,20 -0,60	1,40 -1,80	0,010	0,015	0,55	1,90 -2,60	0,25 -0,65	0,25	0,04	Ti: 0,10 Zr: 0,10 Al: 0,10
S2Ni2Mo e	SUN5M3 c	0,05 -0,09	0,15	1,10 -1,40	0,015	0,015	0,55	2,00 -2,50	0,45 -0,60	0,30	--	0,50
	SUN5M3 c	0,10	0,20 -0,60	1,40 -1,80	0,010	0,015	0,55	2,00 -2,80	0,30 -0,65	0,25	0,03	Ti: 0,10 Zr: 0,10 Al: 0,10
	SUN5M4 c	0,15	0,25	1,60 -2,30	--	--	0,20	2,20 -3,00	0,40 -0,90	--	--	--
(S2Ni3Mo)	SUN6M1 c	0,15	0,25	0,80 -1,40	--	--	--	2,40 -3,70	0,15 -0,40	--	--	--
S2Ni3Mo e	(SUN6M1)	0,08 -0,12	0,10 -0,25	0,80 -1,20	0,020	0,020	0,15	2,80 -3,20	0,10 -0,25	0,30	--	0,50
	SUN6M11 c	0,15	0,25	1,30 -1,90	--	--	--	2,40 -3,70	0,15 -0,40	--	--	--
	SUN6M3 c	Max. 0,15	Max. 0,25	0,80 -1,40	--	--	--	2,40 -3,70	0,40 -0,65	--	--	--



## GUIDE TO EN ISO 26304-A/B: SOLID WIRE ELECTRODES, TUBULAR CORED ELECTRODES AND ELECTRODE-FLUX COMBINATIONS FOR SUBMERGED ARC WELDING OF HIGH STRENGTH STEELS

<b>A</b>	<b>S</b>	<b>69</b>	<b>4</b>	<b>AB</b>	<b>(T)2Ni2Mo</b>	<b>H5</b>
<b>B</b>	<b>S</b>	<b>69A</b>	<b>4</b>	<b>AB</b>	<b>(T)SUN2M2</b>	<b>H5</b>

Chemical composition requirements for solid wire electrodes part 2

Symbol for chemical composition		Chemical composition, % b) c)										
ISO 26304-A, Classification by yield strength and 47 J impact energy	ISO 26304-B, Classification by tensile strength and 27 J impact energy	C	Si	Mn	P	S	Cr	Ni	Mo	Cu	V	Other elements
	SUN6M31 c	0,15	0,25	1,30 -1,90	--	--	--	2,40 -3,70	0,40 -0,65	--	--	--
	SUN1C1M1 c	0,16 -0,23	0,15 -0,35	0,60 -0,90	0,025	0,030	0,40 -0,60	0,40 -0,80	0,15 -0,30	0,35	--	--
(S3Ni1,5CrMo)	SUN2C1M3 c	0,15	0,40	1,30 -2,30	--	--	0,05 -0,70	0,40 -1,75	0,30 -0,80	--	--	--
S3Ni1,5CrMo e	(SUN2C1M3)	0,07 -0,14	0,05 -0,15	1,30 -1,50	0,020	0,020	0,15 -0,35	1,50 -1,70	0,30 -0,50	0,30	--	0,50
	SUN2C2M3 c	0,15	0,40	1,00 -2,30	--	--	0,50 -1,20	0,40 -1,75	0,30 -0,90	--	--	--
	SUN4C2M3 c	0,15	0,40	1,20 -1,90	--	--	0,50 -1,20	1,50 -2,25	0,30 -0,80	--	--	--
(S3Ni2,5CrMo)	SUN4C1M3 c	0,15	0,40	1,20 -1,90	0,018	0,018	0,20 -0,65	1,50 -2,25	0,30 -0,80	0,40	--	--
S3Ni2,5CrMo e	(SUN4C1M3)	0,07 -0,15	0,10 -0,25	1,20 -1,80	0,020	0,020	0,30 -0,85	2,00 -2,60	0,40 -0,70	0,30	--	0,50
S1Ni2,5CrMo e		0,07 -0,15	0,10 -0,25	0,45 -0,75	0,020	0,020	0,50 -0,85	2,10 -2,60	0,40 -0,70	0,30	--	0,50
(S4Ni2CrMo)	SUN5C2M3 c	0,10	0,40	1,30 -2,30	--	--	0,60 -1,20	2,10 -3,10	0,30 -0,70	--	--	--
S4Ni2CrMo e	(SUN5C2M3)	0,08 -0,11	0,30 -0,40	1,80 -2,00	0,015	0,015	0,85 -1,00	2,10 -2,60	0,55 -0,70	0,30	--	0,50
	SUN5CM3 c	0,10 -0,17	0,20	1,70 -2,20	0,015	0,015	0,25 -0,50	2,30 -2,80	0,45 -0,65	0,50	--	--
	SUN7C3M3 c	0,08 -0,18	0,40	0,20 -1,20	--	--	1,00 -2,00	3,00 -4,00	0,30 -0,70	0,40	--	--
	SUN10C1M3 c	0,08 -0,18	0,40	0,20 -1,20	--	--	0,30 -0,70	4,50 -5,50	0,30 -0,70	0,40	--	--
SZe	SUG	Any other Analyse										

a) The individual values given in the table are maximum values.

b) The copper limit value includes any copper coating applied to the electrode.

c) The electrode shall be analyzed for the specific elements for which values are given in the table. If this reveals the presence of other elements, the amount of these elements shall be determined so that their sum (excluding iron) does not exceed 0.50%.

d) This solid wire electrode composition, with a lower strength requirement, is also found in ISO 14171.

e) If not specified: Al, Sn, As and Sb u 0.02 % each and Ti, Pb and N u 0.01 % each.

Chemical composition requirements for Flux cored wire electrodes part 2

Symbol for chemical composition		Chemical composition, % b) c)										
ISO 26304-A, Classification by yield strength and 47 J impact energy	ISO 26304-B, Classification by tensile strength and 27 J impact energy	C	Si	Mn	P	S	Cr	Ni	Mo	Cu	V	Other elements
	TUN1M3 b, c	0,17	0,80	1,25 to 2,25	0,030	0,030	--	0,40 to 0,80	0,40 to 0,65	0,35	--	--
T3NiMo d		0,05 to 0,12	0,20 to 0,60	1,30 to 1,90	0,020	0,020	--	0,60 to 1,00	0,15 to 0,45	--	--	--
	TUN2M3 b	0,17	0,80	1,25 to 2,25	0,030	0,030	--	0,70 to 1,10	0,40 to 0,65	0,35	--	--
(T3Ni1Mo)	TUN2M2 b	0,12	0,80	0,70 to 1,50	0,030	0,030	0,15	0,90 to 1,70	0,55	0,35	--	--
T3Ni1Mo d	(TUN2M2)	0,03 to 0,09	0,10 to 0,50	1,30 to 1,80	0,020	0,020	--	1,00 to 1,50	0,45 to 0,65	--	--	--
	TUN3M1 b	0,10	0,80	0,60 to 1,60	0,030	0,030	0,15	1,25 to 2,00	0,35	0,30	0,03	Ti + V + Zr: 0,03
	TUN3M2 b	0,10	0,80	0,90 to 1,80	0,020	0,020	0,35	1,40 to 2,10	0,25 to 0,65	0,30	--	Ti + V + Zr: 0,03
	TUN3M21 b	0,12	0,50	1,60 to 2,50	0,015	0,015	0,40	1,40 to 2,10	0,20 to 0,50	0,30	0,02	Ti: 0,03 Zr: 0,02
	TUN3M4 b	0,12	0,50	1,60 to 2,50	0,015	0,015	0,40	1,40 to 2,10	0,70 to 1,00	0,30	0,02	Ti: 0,03 Zr: 0,02
T3Ni2MoV d		0,03 to 0,09	0,20	1,20 to 1,70	0,020	0,020	--	1,60 to 2,00	0,20 to 0,50	--	0,05 to 0,15	--
T3Ni2Mo d		0,03 to 0,09	0,40 to 0,80	1,30 to 1,80	0,020	0,020	--	1,80 to 2,40	0,20 to 0,40	--	--	--
	TUN4M2 b	0,10	0,80	0,90 to 1,80	0,020	0,020	0,65	1,80 to 2,40	0,20 to 0,70	0,30	0,03	Ti + V + Zr: 0,03
	TUN5M3 b	0,10	0,80	1,30 to 2,25	0,020	0,020	0,80	2,00 to 2,80	0,30 to 0,80	0,30	0,03	Ti + V + Zr: 0,03
T3Ni3Mo d		0,03 to 0,09	0,20 to 0,70	1,60 to 2,10	0,020	0,020	--	2,70 to 3,20	0,20 to 0,40	--	--	--
	TUN1C1M1 b	0,17	0,80	1,60	0,030	0,035	0,60	0,40 to 0,80	0,25	0,35	0,03	Ti + V + Zr: 0,03
	TUN4C1M3 b	0,14	0,80	0,80 to 1,85	0,030	0,020	0,65	1,50 to 2,25	0,60	0,40	--	--
(T3Ni2,5CrMo)	TUN5CM3 b	0,17	0,80	1,20 to 1,80	0,020	0,020	0,65	2,00 to 2,80	0,30 to 0,80	0,40	--	--
T3Ni2,5CrMo d	(TUN5CM3)	0,03 to 0,09	0,10 to 0,50	1,20 to 1,70	0,020	0,020	0,40 to 0,70	2,20 to 2,60	0,30 to 0,60	--	--	--
T3Ni2,5Cr1Mo d		0,04 to 0,10	0,20 to 0,70	1,20 to 1,70	0,020	0,020	0,70 to 1,20	2,20 to 2,60	0,40 to 0,70	--	--	--
TZe d	TUG b	Any other agreed composition										

a) The individual values given in the table are maximum values.

b) The copper limit value includes any copper coating applied to the electrode.

c) The electrode shall be analyzed for the specific elements for which values are given in the table. If this reveals the presence of other elements, the amount of these elements shall be determined so that their sum (excluding iron) does not exceed 0.50%.

d) This solid wire electrode composition, with a lower strength requirement, is also found in ISO 14171.

e) If not specified: Al, Sn, As and Sb u 0.02 % each and Ti, Pb and N u 0.01 % each.

## GUIDE TO EN ISO 26304: SOLID WIRE ELECTRODES, TUBULAR CORED ELECTRODES AND ELECTRODE-FLUX COMBINATIONS FOR SUBMERGED ARC WELDING OF HIGH STRENGTH STEELS

Supplementary Info: COMPARISON OF SOLID ELECTRODE DESIGNATIONS						
AWS A5.23/A5.23M Classification	ISO 14171b		ISO 24598c		ISO 26304d	
	ISO 14171-A	ISO 14171-B	ISO 24598-A	ISO 24598-B	ISO 26304-A	ISO 26304-B
EL8e	S1	(SU11)	-	-	-	-
EL8Ke	S1Si1	SU12	-	-	-	-
EL12e	S1	SU11	-	-	-	-
EM11Ke	-	SU25	-	-	-	-
EM12e	S2	SU22	-	-	-	-
EM12Ke	S2Si	SU21	-	-	-	-
EM13K e	S2Si2	SU25	-	-	-	-
EM14Ke	-	SU24	-	-	-	-
EM15K e	S2Si	(SU21)	-	-	-	-
EH10K e	S3Si	SU32	-	-	-	-
EH11K e	-	SU31	-	-	-	-
EH12K e	S4Si	SU42	-	-	-	-
EH114e	-	SU41	-	-	-	-
EA1	-	SU1M3	(SMo)	SU1M3	-	-
EA1TiB	-	-	-	-	-	-
EA2	S2Mo	SU2M3	SMo	SU2M3	-	-
EA3	S4Mo	SU4M3	-	SU4M3	-	-
EA3K	-	SU4M31	-	SU4M32	-	-
EA4	S3Mo	SU3M3	SMnMo	SU3M3	-	-
EB1	-	-	-	SUCM	-	-
EB2g	-	-	SCrMo1	SU1CM	-	-
EB2H	-	-	-	Su1CMVH	-	-
EB3g	-	-	SCrMo2	SU2C1M	-	-
EB5	-	-	-	SUC1MH	-	-
EB6	-	-	SCrMo5	SU5CM	-	-
EB6H	-	-	-	SU5CMH	-	-
EB8	-	-	SCrMo9	SU9C1M	-	-
EB9	-	-	-	SU9C1MV	-	-
ENi1	S2Ni1	SUN2	-	-	-	-
ENi1K	-	SUN21	-	-	-	-
ENi2	-	SUN5	-	-	-	-
ENi3	S2Ni3	SUN7	-	-	-	-
ENi4	-	SUN4M1	-	-	-	SUN4M1
ENi5	-	SUN2M1	-	-	-	SUN2M1
EF1					S2Ni1Mo	SUN2M2
EF2						SUN1M3
EF3						SUN2M33
EF4						SUN1C1M1
EF5						SUN5CM3
EF6						SUN4C1M3
EM2i						SUN3M2
EM3i						SUN4C1M2
EM4i						SUN5C1M3
EW	SUNCC1					

**NOTES:**

- d. ISO 26304, Welding consumables  
- Solid wire electrodes, tubular cored electrodes and electrode/flux combinations for submerged arc welding of high strength steels  
- Classification, is a cohabitation document. The classification according to system A is mainly based on EN 14295. The classification according to system B is mainly based upon standards used around the Pacific Rim. This ISO document is still under review and has not yet been released for publication.
- e. These solid wire electrode classifications also appear in AWS A5.17/A5.17M.

GUIDE TO DIN 2302: COVERED ELECTRODES FOR MANUAL METAL ARC WELDING OF NON-ALLOY AND FINE GRAIN STEELS IN A WET HYPERBARIC ENVIRONMENT

Symbol	Tensile Strength	Yield Strength
	MPa	min. MPa
35	440-570	355
38	470-600	380
42	500-640	420

PA = Flat position  
 PB = Horizontal-vertical position  
 PC = Transverse position  
 PD = Horizontal overhead position  
 PE = Overhead position  
 PF = Vertical up position  
 PG = Vertical down position

E = Covered electrode for manual metal arc

Symbols for welding position according to ISO 6947



<b>E</b>	<b>42</b>	<b>2</b>	<b>-</b>	<b>B</b>	<b>6</b>	<b>(PA,PG,PD)</b>	<b>sa</b>
----------	-----------	----------	----------	----------	----------	-------------------	-----------

Symbol	Impact Energy Charpy-V Temp °C for 27J min.
Z	No requirements
A	20
0	0
2	-20

Symbol	Coating type
R	Rutile
RR	Rutile (thick coated)
RA	Rutile-Acid
RB	Rutile-Basic
B	Basic

**Symbol for salt content of water**  
 The test conditions under which the classification requirements were met shall be indicated by the following symbols:

- sa salt water;
- fr fresh water (sweet water).  
 Sweet water tests include tests in salt water but not vice versa.

**NOTE**  
 The salt content of the water improves the ignition characteristics due to the better ionisation.

Symbol	Chemical composition of all-weld metal , % *		
	Mn	Mo	Ni
No symbol	2.0	-	-
Mo	1,40	0.3 - 0.6	-
MnMo	1.4 - 2.0	0.3 - 0.6	-
1Ni	1,40	-	0.6 - 1.2
Z	Any other agreed composition		

**Symbol for water depth**  
 The mean water depth, in m, at which welding was performed shall be specified as symbol without unit. The depth shall be measured on the test seam with a precision of ± 250 mm. The greatest depth shall be measured on the lowest point of the test seam and the smallest depth shall be measured on the highest point of the test seam.

## GUIDE TO AWS A5.1: CARBON STEEL ELECTRODES FOR SHIELDED METAL ARC WELDING

E = Covered electrode for manual metal arc

Designates an electrode for military requirements. Greater toughness, low H<sub>2</sub>

Designates that the electrode (E 7016, E 7018, E 7024) meets the requirements for improved toughness – and ductility

Symbol	Hydrogen content ml/100g weld metal
H2	2
H4	4
H8	8
H16	16

**E 70 18 M**

**E 70 18 -1 HZ R**

Designates that the electrode meets the requirements of the moisture pick-up test (optional for all basic electrodes except E 7018M, for which the test is mandatory hydrogen limits for weld metal

AWS Classification	Tensile Strength min.		Yield Strength min.		Elongation min. %	Impact Energy Charpy-V J/°C	Welding Position	Type of coating	Type of Current	
	ksi	MPa	ksi	MPa					AC	DC
E 6010	60	430	48	330	22	27 / -30	1	Cellulosic sodium	-	+pol
E 6011	60	430	48	330	22	27 / -30	1	Cellulosic potassium	x	+ pol
E 6012	60	430	48	330	17	Not spec.	1	Rutile/ Titan sodium	x	- pol
E 6013	60	430	48	330	17	Not spec.	1	Rutile/ Titan potassium	x	+/- pol
E 6019	60	430	48	330	22	27 / -20	1	Rutile/Iron oxide titania potassium	x	+/- pol
E 6020	60	430	48	330	22	Not spec.	2	Acid / High iron oxide	x	c) +/- pol
E 6022	60	430	Not spec.	Not spec.	Not spec.	Not spec.	2	Acid / High iron oxide	x	- pol
E 6027	60	430	48	330	22	27 / -30	2	Acid, high recovery /High iron oxide, iron powder	x	c) +/- pol
E 7014	70	490	58	400	17	Not spec.	1	Rutile / Iron powder, titania	x	+/- pol
E 7014	70	490	58	400	17	Not spec.	1	Rutile / Iron powder, titania	x	+/- pol
E 7015	70	490	58	400	22	27 / -30	1	Basic / Low hydrogen sodium	-	+pol
E 7016	70	490	58	400	22	27 / -30	1	Basic / Low hydrogen potassium	x	+ pol
E 7018	70	490	58	400	22	27 / -30	1	Basic / Low-hydrogen potassium, iron powder	x	+ pol
E 7018 M	a)	490	b)	b)	24	67 / -30	1	Basic / Low-hydrogen iron powder	-	+pol
E 7024	70	490	58	400	17	Not spec.	2	Rutile, high recovery / Iron powder, titania	x	+/- pol
E 7027	70	490	58	400	22	27 / -30	2	Acid, high recovery / High iron oxide, iron powder	x	c) +/- pol
E 7028	70	490	58	400	22	27 / -20	2	Basic, high recovery Low-hydrogen potassium, iron powder	x	+pol
E 7048	70	490	58	400	22	27 / -30	4	Basic / Low-hydrogen potassium, iron powder	x	+ pol

A 5.1	USN	C	Mn	Si	P	S	Ni	Cr	Mo	V	
E 6010	W06010	0,20	1,2	1,00	N.S.	N.S.	0,30	0,20	0,30	0,08	N.S.
E 6011	W06011										
E 6012	W06012										
E 6013	W06013										
E 6019	W06019										
E 6020	W06020										
E6027	W06027										
E 6018	W06018	0,03	0,60	0,40	0,025	0,15	0,30	0,20	0,30	0,08	N.S.
E 7015	W07015	0,15	0,125	0,90	0,035	0,035	0,30	0,20	0,30	0,08	1,50
E 7016	W07016	0,15	1,60	0,75	0,035	0,035	0,30	0,20	0,30	0,08	1,75
E 7018	W07018	0,15	1,60	0,75	0,035	0,035	0,30	0,20	0,30	0,08	1,75
E 7014	W07014	0,15	1,25	0,90	0,035	0,035	0,30	0,20	0,30	0,08	1,50
E 7024	W07024	0,15	1,25	0,90	0,035	0,035	0,30	0,20	0,30	0,08	1,50
E 7027	W07027	0,15	1,60	0,75	0,035	0,035	0,30	0,20	0,30	0,08	1,75
E 7028	W07028	0,15	1,60	0,90	0,035	0,035	0,30	0,20	0,30	0,08	1,75
E7048	W07048										
E 7018M	W07018	0,12	0,4-1,6	0,80	0,030	0,20	0,25	0,15	0,35	0,05	N.S.

Symbol	Welding Position
1	All positions except vertical-down F,V,OH,H
2	Flat and H-V fillets
4	All positions but in the vertical, V-down only

**Additional information about the coating**

**The coatings of welding electrodes for welding mild and low alloy steels may have from 6 to 12 ingredients, which includes:**

- **Cellulose** – to provide a gaseous shield with a reducing agent in which the gas shield surrounding the arc is produced by the disintegration of cellulose
- **Metal carbonates** – to adjust the basicity of the slag and to provide a reducing atmosphere
- **Titanium dioxide** – to help form a highly fluid, but quick-freezing slag and to provide ionization for the arc
- **Ferromanganese & ferrosilicon** – to help deoxidize the molten weld metal and to supplement the manganese content and silicon content of the deposited weld metal
- **Clays & gums** – to provide elasticity for extruding the plastic coating material and to help provide strength to the coating
- **Calcium fluoride** – to provide shielding gas to protect the arc, adjust the basicity of the slag, and provide fluidity and solubility of the metal oxides
- **Mineral silicates** – to provide slag and give strength to the electrode covering
- **Alloying metals including nickel, molybdenum, and chromium** – to provide alloy content to the deposited weld metal
- **Iron or manganese oxide** – to adjust the fluidity and properties of the slag and to help stabilize the arc
- **Iron powder** – to increase the productivity by providing extra metal to be deposited in the weld.

**1. Cellulose-sodium (EXX10):** Electrodes of this type cellulosic material in the form of wood flour or reprocessed low alloy electrodes have up to 30 percent paper. The gas shield contains carbon dioxide and hydrogen, which are reducing agents. These gases tend to produce a digging arc that provides deep penetration. The weld deposit is somewhat rough, and the spatter is at a higher level than other electrodes. It does provide extremely good mechanical properties, particularly after aging. This is one of the earliest types of electrodes developed, and is widely used for cross country pipe lines using the downhill welding technique. It is normally used with direct current with the electrode positive (reverse polarity).

**2. Cellulose-potassium (EXX11):** This electrode is very similar to the cellulose-sodium electrode, except more potassium is used than sodium. This provides ionization of the arc and makes the electrode suitable for welding with alternating current. The arc action, the penetration, and the weld results are very similar. In both E6010 and E6011 electrodes, small amounts of iron powder may be added. This assists in arc stabilization and will slightly increase the deposition rate.

**3. Rutile-sodium (EXX12):** When rutile or titanium dioxide content is relatively high with respect to the other components, the electrode will be especially appealing to the welder. Electrodes with this coating have a quiet arc, an easily controlled slag, and a low level of spatter. The weld deposit will have a smooth surface and the penetration will be less than with the cellulose electrode. The weld metal properties will be slightly lower than the cellulosic types. This type of electrode provides a fairly high rate of deposition. It has a relatively low arc voltage, and can be used with alternating current or with direct current with electrode negative (straight polarity).

## GUIDE TO AWS A5.1: CARBON STEEL ELECTRODES FOR SHIELDED METAL ARC WELDING

- 4. 4. Rutile-potassium (EXX13):** This electrode coating is very similar to the rutile-sodium type, except that potassium is used to provide for arc ionization. This makes it more suitable for welding with alternating current. It can also be used with direct current with either polarity. It produces a very quiet, smooth running arc.
- 5. Rutile-iron powder (EXXX4):** This coating is very similar to the rutile coatings mentioned above, except that iron powder is added. If iron content is 25 to 40 percent, the electrode is EXX14. If iron content is 50 percent or more, the electrode is EXX24. With the lower percentage of iron powder, the electrode can be used in all positions. With the higher percentage of iron powder, it can only be used in the flat position or for making horizontal fillet welds. In both cases, the deposition rate is increased, based on the amount of iron powder in the coating.
- 6. Low hydrogen-sodium (EXXX5):** Coatings that contain a high proportion of calcium carbonate or calcium fluoride are called low hydrogen, lime ferritic, or basic type electrodes. In this class of coating, cellulose, clays, asbestos, and other minerals that contain combined water are not used. This is to ensure the lowest possible hydrogen content in the arc atmosphere. These electrode coatings are baked at a higher temperature. The low hydrogen electrode family has superior weld metal properties. They provide the highest ductility of any of the deposits. These electrodes have a medium arc with medium or moderate penetration. They have a medium speed of deposition, but require special welding techniques for best results. Low hydrogen electrodes must be stored under controlled conditions. This type is normally used with direct current with electrode positive (reverse polarity).
- 7. Low hydrogen-potassium (EXXX6):** The coatings in this class of electrodes are similar to the low-hydrogen type mentioned above. However, iron powder is added to the electrode, and if the content is higher than 35 to 40 percent, the electrode is classified as an EXX18.
- 8. Low hydrogen-iron powder (EXX28):** This electrode is similar to the EXX18, but has 50 percent or more iron powder in the coating. It is usable only when welding in the flat position or for making horizontal fillet welds. The deposition rate is higher than EXX18. Low hydrogen coatings are used for all of the higher-alloy electrodes. By additions of specific metals in the coatings, these electrodes become the alloy types where suffix letters are used to indicate weld metal compositions. Electrodes for welding stainless steel are also the low-hydrogen type.
- 9. Iron oxide-sodium (EXX20):** Coatings with high iron oxide content produce a weld deposit with a large amount of slag. This can be difficult to control. This coating type produces high-speed deposition, and provides medium penetration with low spatter level. The resulting weld has a very smooth finish. The electrode is usable only with flat position welding and for making horizontal fillet welds. The electrode can be used with alternating current or direct current with either polarity.
- 10. Iron-oxide-iron powder (EXX27):** This type of electrode is very similar to the iron oxide-sodium type, except it contains 50 percent or more iron powder. The increased amount of iron powder greatly increases the deposition rate. It may be used with alternating direct current of either polarity.

## GUIDE TO AWS A5.2: CARBON AND LOW-ALLOY STEEL RODS FOR OXYFUEL GAS WELDING

The prefix "R [RM]" designates a rod

**R 45**

AWS Classification	Tensile Strength min.		Elongation min. %
	ksi	MPa	
R45	Not Specified		
R60	60	400	20
R65	65	450	16
R100	100	690	14
R(X)XX-Gb	xxx b	xxx c	Not Specified

**NOTES:**

- Specimens shall be tested in the as-welded condition.
- For specification A5.2, classifications R(X)XX-G should be based on minimum tensile strength of all-weld tension test of the test assembly, expressed in multiples of 1000 psi. These designators shall be limited to 45, 60, 65, and 100.
- For specification A5.2M, classifications RMXX-G should be based on minimum tensile strength of all-weld tension test of the test assembly, expressed in multiples of 10 MPa. These designators shall be limited to 30, 40, 45, and 69.

A5.2	A5.2M	USNa	C	Mn	Si	P	S	Cu	Cr	Ni	Mo	Al
R45	RM30	K00045	0,08	0,50	0,10	0,035	0,040	0,30	0,20	0,30	0,20	0,02
R60	RM40	K00060	0,15	0,90 -1,40	0,10 - 0,35	0,035	0,035	0,30	0,20	0,30	0,20	0,02
R65	RM45	K00065	0,15	0,90 - 1,60	0,10 -0,70	0,035	0,035	0,30	0,40	0,30	0,20	0,02
R100	RM69	K12147	0,18-0,23	0,70-0,90	0,20-0,35	0,025	0,025	0,15	0,40-0,60	0,40-0,70	0,15-0,25	0,02
R(X)XX-Gc	RMXX-Gd	Not Specified										

**NOTES:**

- SAE HS-1086/ASTM DS-56, Metals & Alloys in the Unified Numbering System.
- Single values are maxima.
- Designators, "(X)XX" correspond to minimum tensile strength of weld metal in ksi (see Note b of Table 1).
- Designators, "XX" correspond to minimum tensile strength of weld metal in multiples of 10 MPa (see Note c of Table 1).

**Class R45 [RM30]** welding rods are used for the oxyfuel gas welding of steels, where the minimum tensile strength requirement of the steel does not exceed 45 ksi [300 MPa]. Class R45 [RM30] rods have a low carbon steel composition.

**Class R60 [RM40]** welding rods are used for the oxyfuel gas welding of carbon steels, where the minimum tensile strength requirement of the steel does not exceed 60 ksi [400 MPa]. Class R60 [RM40] rods have a carbon steel composition.

**Class R65 [RM45]** welding rods are used for the oxyfuel gas welding of carbon and low-alloy steels, where the minimum tensile strength requirement of the steel does not exceed 65 ksi [450 MPa]. Class R65 [RM45] welding rods may have either a low-alloy or an unalloyed carbon steel composition.

**Class R100 [RM69]** welding rods are used for the oxyfuel gas welding of low-alloy steels, where the minimum tensile strength requirement of the steel does not exceed 100 ksi [690 MPa] in the as-welded condition. Users are cautioned that response of the weld metal and base metal to postweld heat treatment may be different.



## GUIDE TO AWS A5.3: ALUMINUM AND ALUMINUM-ALLOY ELECTRODES FOR SHIELDED METAL ARC WELDING

The prefix "E [EA]" designates Electrode	AWS	Tensile Strength min.	
<div style="border: 1px solid black; padding: 2px; display: inline-block; background-color: #e0f0ff;">E</div> <div style="border: 1px solid black; padding: 2px; display: inline-block; background-color: #e0f0ff;">1000</div>	Classification	ksi	MPa
	E1100	12	80
	E3003	14	95
	E4043	14	95

**NOTES:**

- a. Fracture may occur in either the base metal or the weld metal.

A 5.3	USNa	Si	Fe	Cu	Mn	Mg	Zn	Ti	Be	Other		Al
										Each	Total	
E1100	A91100	d	d	0,05-0,20	0,05	-	0,10	-	0,0008	0,05	0,15	99,9
E3003	A93003	0,60	0,7	0,05-0,20	1,0-1,5	-	0,10	-	0,0008	0,05	0,15	Remainder
E4043	A94043	4,5 - 6,0	0,8	0,30	0,05	0,05	0,10	0,20	0,0008	0,05	0,15	Remainder

**NOTES:**

- a. The core wire, or the stock from which it is made, shall be analyzed for the specific elements for which values are shown in this table. If the presence of other elements is indicated in the course of work, the amount of those elements shall be determined to ensure that they do not exceed the limits specified for "Other Elements."
- b. Single values are maximum, except where otherwise specified.
- c. SAE/ASTM Unified Numbering System for Metals and Alloys.
- d. Silicon plus iron shall not exceed 0.95 percent.
- e. The aluminum content for unalloyed aluminum is the difference between 100.00 percent and the sum of all other metallic elements present in amounts of 0.010 percent or more each, expressed to the second decimal before determining the sum.
- f. Refer to Table A1 for Proposed ISO Designations.

**E1100** classification produce weld metal of high ductility, good electrical conductivity, and a minimum tensile strength of 12 000 psi (80 MPa). E1100 electrodes are used to weld 1100, 1350(EC), and other commercially pure aluminum alloys.

**E3003** classification produce weld metal of high ductility and a minimum tensile strength of 14 000 psi [95 MPa]. E3003 electrodes are used to weld aluminum alloys 1100 and 3003.

**E4043** classification contains approximately five-percent silicon, which provides superior fluidity at welding temperatures, and for this reason is preferred for general purpose welding. The E4043 classification produces weld metal with fair ductility and a minimum tensile strength of 14 000 psi [95 MPa]. E4043 electrodes can be used to weld the 6XXX series aluminum alloys, the 5XXX series aluminum alloys (up to 2.5-percent Mg content), and aluminum-silicon casting alloys, as well as aluminum base metals 1100, 1350(EC), and 3003.

**For many aluminum applications, corrosion resistance of the weld is of prime importance. In such cases, it is advantageous to choose an electrode with a composition as close as practical to that of the base metal. For this use, covered electrodes for base metals other than 1100 and 3003 usually are not stocked and must be specially ordered. For applications where corrosion resistance is important, it may be advantageous to use one of the gas shielded arc welding processes for which a wider range of filler metal compositions is available.**

GUIDE TO AWS A5.4: SMAW ELECTRODES FOR STAINLESS STEEL

E = Covered electrode

**E 309L -17**

Suffix	Coating type and usability characteristics
-15	For use with DC+ only. Usually basic coating. All positions.
-16	For use with DC + and AC. Rutile coating. All positions.
-17	As for -16, but higher silica content in coating gives following: - More of a spray arc and finer rippled bead surface in H-V fillets. - Slower freezing slag permits improved handling with a drag technique. - Mitre to slight concave H-V fillets - When making vertical-up fillets the slower freezing slag requires slight weave to produce flat profile.
-25	Same coating and type as for -15 but with a mild steel core wire. Flat and horizontal positions only.
-26	Same coating and type as for -16 but with a mild steel core wire. Flat and horizontal positions only.

AWS	ISO 3581	C	Cr	Ni	Mo	Nb +Ta	Mn	Si	P	S	N	Cu	Other
E209-xx	-	0.06	20.5-24.0	9.5-12.0	1.5-3.0	-	4.0-7.0	1.00	0.04	0.03	0.10-0.30	0.75	V 0.1-0.3
E219-xx	-	0.06	19.0-21.5	5.5-7.0	0.75	-	8.0-10.0	1.00	0.04	0.03	0.10-0.30	0.75	
E240-xx	-	0.06	17.0-19.0	4.0-6.0	0.75	-	10.5-13.5	1.00	0.04	0.03	0.10-0.30	0.75	
E307-xxx	E18 9 MnMo	0.04-0.14	18.0-21.5	9.0-10.7	0.5-1.5	-	3.30-4.75	1.00	0.04	0.03	-	0.75	
E308-xx	E19 9	0.08	18.0-21.0	9.0-11.0	0.75	-	0.5-2.5	1.00	0.04	0.03	-	0.75	
E308H-xx	E19 9 H	0.04-0.08	18.0-21.0	9.0-11.0	0.75	-	0.5-2.5	1.00	0.04	0.03	-	0.75	
E308L-xx	E19 9 L	0.04	18.0-21.0	9.0-11.0	0.75	-	0.5-2.5	1.00	0.04	0.03	-	0.75	
E308Mo-xx	E20 10 3	0.08	18.0-21.0	9.0-12.0	2.0-3.0	-	0.5-2.5	1.00	0.04	0.03	-	0.75	
E308LMo-x x*	-	0.04	18.0-21.0	9.0-12.0	2.0-3.0	-	0.5-2.5	1.00	0.04	0.03	-	0.75	
E309-xx	E22 12	0.15	22.0-25.0	12.0-14.0	0.75	-	0.5-2.5	1.00	0.04	0.03	-	0.75	
E309H-xx	-	0.04-0.15	22.0-25.0	12.0-14.0	0.75	-	0.5-2.5	1.00	0.04	0.03	-	0.75	
E309L-xx	E22 12 L	0.04	22.0-25.0	12.0-14.0	0.75	-	0.5-2.5	1.00	0.04	0.03	-	0.75	
E309Nb-xx	E23 12 Nb	0.12	22.0-25.0	12.0-14.0	0.75	0.70-1.00	0.5-2.5	1.00	0.04	0.03	-	0.75	
E309Mo-xx	-	0.12	22.0-25.0	12.0-14.0	2.0-3.0	-	0.5-2.5	1.00	0.04	0.03	-	0.75	
E309LMo-x x*	E23 12 L	0.04	22.0-25.0	12.0-14.0	2.0-3.0	-	0.5-2.5	1.00	0.04	0.03	-	0.75	
E310-xx	E25 20	0.08-0.20	25.0-28.0	20.0-22.5	0.75	-	1.0-2.5	0.75	0.03	0.03	-	0.75	
E310H-xx	E25 20 H	0.35-0.45	25.0-28.0	20.0-22.5	0.75	-	1.0-2.5	0.75	0.03	0.03	-	0.75	
E310Nb-xx	-	0.12	25.0-28.0	20.0-22.0	0.75	0.70-1.00	1.0-2.5	0.75	0.03	0.03	-	0.75	
E310Mo-xx	-	0.12	25.0-28.0	20.0-22.0	2.0-3.0	-	1.0-2.5	0.75	0.03	0.03	-	0.75	
E312-xx	E29 9	0.15	28.0-32.0	8.0-10.5	0.75	-	0.5-2.5	1.00	0.04	0.03	-	0.75	
E316-xx	E19 12 2	0.08	17.0-20.0	11.0-14.0	2.0-3.0	-	0.5-2.5	1.00	0.04	0.03	-	0.75	
E316H-xx	-	0.04-0.08	17.0-20.0	11.0-14.0	2.0-3.0	-	0.5-2.5	1.00	0.04	0.03	-	0.75	
E316L-xx	E19 12 3 L	0.04	17.0-20.0	11.0-14.0	2.0-3.0	-	0.5-2.5	1.00	0.04	0.03	-	0.75	
E316LMn-xx	E20 16 3 Mn N L	0.04	18.0-21.0	15.0-18.0	2.5-3.5	-	5.0-8.0	0.9	0.04	0.03	0.10-0.25	0.75	
E317-xx	-	0.08	18.0-21.0	12.0-14.0	3.0-4.0	-	0.5-2.5	1.00	0.04	0.03	-	0.75	
E317L-xx	-	0.04	18.0-21.0	12.0-14.0	3.0-4.0	-	0.5-2.5	1.00	0.04	0.03	-	0.75	
E318-xx	E19 9 Nb	0.08	17.0-20.0	11.0-14.0	2.0-3.0	6xC<1.00	0.5-2.5	1.00	0.04	0.03	-	0.75	
E320-xx	-	0.07	19.0-21.0	32.0-36.0	2.0-3.0	8xC<1.00	0.5-2.5	0.60	0.04	0.03	-	3.0-4.0	
E320LR-xx	-	0.03	19.0-21.0	32.0-36.0	2.0-3.0	8xC<0.40	1.50-2.50	0.30	0.020	0.015	-	3.0-4.0	
E330-xx	E18 36	0.18-0.25	14.0-17.0	33.0-37.0	0.75	-	1.0-2.5	1.00	0.04	0.03	-	0.75	
E330H-xx	-	0.35-0.45	14.0-17.0	33.0-37.0	0.75	-	1.0-2.5	1.00	0.04	0.03	-	0.75	
E347-xx	E19 9 Nb	0.08	18.0-21.0	9.0-11.0	0.75	8xC<1.00	0.5-2.5	1.00	0.04	0.03	-	0.75	
E349-xx	-	0.13	18.0-21.0	8.0-10.0	0.35-0.65	0.75-1.20	0.5-2.5	1.00	0.04	0.03	-	0.75	V 0.1,0-3 / T<0,15 W 1,25-1,75
E383-xx	-	0.03	26.5-29.0	30.0-33.0	3.2-4.2	-	0.5-2.5	0.90	0.02	0.02	-	0.6-1.5	
E385-xx	-	0.03	19.5-21.5	24.0-26.0	4.2-5.2	-	1.0-2.5	0.90	0.03	0.02	-	1.2-2.0	
E409Nb-xx	-	0.12	11.0-14.0	0.6	0.75	0.50-1.50	1.0	1.00	0.04	0.03	-	0.75	
E410-xx	E13	0.12	11.0-13.5	0.7	0.75	-	1.0	0.90	0.04	0.03	-	0.75	
E410NiMo-x x	E13 4	0.06	11.0-12.5	4.0-5.0	0.40-0.70	-	1.0	0.90	0.04	0.03	-	0.75	
E430-xx	E17	0.10	15.0-18.0	0.6	0.75	-	1.0	0.90	0.04	0.03	-	0.75	
E430Nb-xx	-	0.10	15.0-18.0	0.6	0.75	0.50-1.50	1.0	1.00	0.04	0.03	-	0.75	
E630-xx	-	0.05	16.00-16.75	4.5-5.0	0.75	0.15-0.30	0.25-0.75	0.75	0.04	0.03	-	3.25-4.00	
E16-8-2-xx	E16 8 2	0.10	14.5-16.5	7.5-9.5	1.0-2.0	-	0.5-2.5	0.60	0.03	0.03	-	0.75	
E2209-xx	E22 9 3 N L	0.04	21.5-23.5	8.5-10.5	2.5-3.5	-	0.5-2.0	1.00	0.04	0.03	0.08-0.20	0.75	
E2553-xx	-	0.06	24.0-27.0	6.5-8.5	2.9-3.9	-	0.5-1.5	1.00	0.04	0.03	0.10-0.25	1.5-2.5	
E2593-xx	E25 9 3 Cu N L	0.04	24.0-27.0	8.5-10.5	2.9-3.9	-	0.5-1.5	1.00	0.04	0.03	0.08-0.25	1.5-3.0	
E2594-xx	E 25 9 4 Cu N L	0.04	24.0-27.0	8.0-10.5	3.5-4.5	-	0.5-2.0	1.00	0.04	0.03	0.20-0.30	0.75	
E2595-xx	-	0.04	24.0-27.0	8.0-10.5	2.5-4.5	-	2,50	1,20	0.03	0.025	0.20-0.30	0.4-1.5	W 0.4-1.0
E3155-xx	-	0.10	20.0-22.5	19.0-21.0	2.5-3.5	0.75-1.25	1.0-2.5	1.00	0.04	0.03	-	0.75	Co 18.5-21.0, W 2.0-3.0
E33-31-xx	-	0.03	31.0-35.0	30.0-32.0	1.0-2.0	-	2.5-4.0	0.9	0.02	0.01	0.3-0.5	0.4-0.8	

7

## GUIDE TO AWS A5.4: SMAW ELECTRODES FOR STAINLESS STEEL

E	309L	-17
---	------	-----

AWS	ISO 3581	Tensile Strength, min		Elongation	Heat Treatment
		ksi	MPa		
E209-xx	-	100	690	15	None
E219-xx	-	90	620	15	None
E240-xx	-	100	690	15	None
E307-xxx	E18 9 MnMo	85	590	30	None
E308-xx	E19 9	80	550	35	None
E308H-xx	E19 9 H	80	550	35	None
E308L-xx	E19 9 L	75	520	35	None
E308Mo-xx	E20 10 3	80	550	35	None
E308LMo-x x*	-	75	520	35	None
E309-xx	E22 12	80	550	30	None
E309H-xx	-	80	550	30	None
E309L-xx	E22 12 L	75	520	30	None
E309Nb-xx	E23 12 Nb	80	550	30	None
E309Mo-xx	-	80	550	30	None
E309LMo-x x*	E23 12 L	75	520	30	None
E310-xx	E25 20	80	550	30	None
E310H-xx	E25 20 H	90	620	10	None
E310Nb-xx	-	80	550	25	None
E310Mo-xx	-	80	550	30	None
E312-xx	E29 9	95	660	22	None
E316-xx	E19 12 2	75	520	30	None
E316H-xx	-	75	520	30	None
E316L-xx	E19 12 3 L	70	490	30	None
E316LMn-xx	E20 16 3 Mn N L	80	550	20	None
E317-xx	-	80	550	30	None
E317L-xx	-	75	520	30	None
E318-xx	E19 9 Nb	80	550	25	None
E320-xx	-	80	550	30	None
E320LR-xx	-	75	520	30	None
E330-xx	E18 36	75	520	25	None
E330H-xx	-	90	620	10	None
E347-xx	E19 9 Nb	75	520	30	None
E349-xx	-	100	690	25	None
E383-xx	-	75	520	30	None
E385-xx	-	75	520	30	None
E409Nb-xx	-	65	450	20	D
E410-xx	E13	75	520	20	B
E410NiMo-x x	E13 4	110	760	15	C
E430-xx	E17	65	450		D
E430Nb-xx	-	65	450		D
E630-xx	-	135	930		E
E16-8-2-xx	E16 8 2	80	550		None
E2209-xx	E22 9 3 N L	100	690		None
E2553-xx	-	110	760		None
E2593-xx	E25 9 3 Cu N L	110	760		None
E2594-xx	E 25 9 4 Cu N L	110	760		None
E2595-xx	-	110	760		None
E3155-xx	-	100	690		None
E33-31-xx	-	105	720		None

**NOTES:**

(A) E308LMo-XX, E309LMo-XX, E309Nb-XX, and E310Nb-XX were formerly named E308MoL-XX, E309MoL-XX, E309Cb-XX, and E310Cb-XX, respectively. The change was made to conform to the worldwide uniform designation of the element niobium.

(B) Heat to 1350°F to 1400°F [730°C to 760°C], hold for one hour (-0, +15 minutes), furnace cool at a rate not exceeding 200°F [110°C] per hour to 600°F [315°C] and air cool to ambient.

(C) Heat to 1100°F to 1150°F [595°C to 620°C], hold for one hour (-0, +15 minutes), and air cool to ambient.

(D) Heat to 1400°F to 1450°F [760°C to 790°C], hold for two hours (-0, +15 minutes), furnace cool at a rate not exceeding 100°F [55°C] per hour to 1100°F [595°C] and air cool to ambient.

(E) Heat to 1875°F to 1925°F [1025°C to 1050°C], hold for one hour (-0, +15 minutes), and air cool to ambient, and then precipitation harden at 1135°F to 1165°F [610°C to 630°C], hold for four hours (-0, +15 minutes), and air cool to ambient.

GUIDE TO AWS A5.5: ELECTRODES FOR LOW-ALLOY STEEL FOR SHIELDED METAL ARC WELDING

E = Covered electrode for manual metal arc

Indicates chemical deposition M Designates an electrode for military requirements. Greater toughness, low H<sub>2</sub>

E 80 16 D3

Designates that the electrode meets the requirements of the moisture pick-up test

E 80 18 M HZ R

Designates that the electrode meets the requirements of the moisture pick-up test (optional for all basic electrodes except E 7018M, for which the test is mandatory hydrogen limits for weld metal

E 80 18 D3 HZ R

AWS Classification	Tensile Strength	Yield Strength
	min. MPa	min. MPa
E 70xx-x	490	390
E 70xx-BL2	520	390
E 70xx-P1	490	415
E 70xx-W1	490	415
E 80xx-x	550	460
E 80xx-C3	550	470-550
E 90xx-x	620	530
E 90xx-M	620	540-620
E 100xx-x	690	600
E 100xx-M	690	610-690
E 110xx-x	760	670
E 110xx-M	760	680-760
E 120xx-x	830	740
E 120xx-M	830	745-830
E 120xx-M1	830	745-830

AWS Classification	Welding Position	Type of coating	Type of Current	
			AC	DC
E xx10	1	Cellulosic	-	+pol
E xx11	1	Cellulosic	x	+pol
E xx13	1	Rutile	x	+/- pol
E xx15	1	Basic	-	+pol
E xx16	1	Basic	x	+pol
E xx18	1	Basic, iron powder	x	+pol
E xx20	2	Acid	x	c) +/- pol
E xx27	2	Acid, high recovery	x	c) +/- pol

a) H-V fillets: - pol

Symbol	Welding Position
1	All positions, except vertical down
2	Flat and H-V fillets

AWS Classification	Impact Energy	
	min. J	°C
E 7010-P1	27	-30
E 8010-P1	27	-30
E 8018-P2	27	-30
E 8045-P2	27	-30
E 9010-P1	27	-30
E 9018-P2	27	-30
E 9045-P2	27	-30
E 10045-P2	27	-30
E 8018-NM1	27	-40
E 8016-C3	27	-40
E 8018-C3	27	-40
E 7018-C3L	27	-50
E 8016-C4/D3	27	-50
E 8018-C4/D3	27	-50
E 9015-D1	27	-50
E 9018-D1/D3	27	-50
E 10015-D2	27	-50
E 10016-D2	27	-50
E 10018-D2	27	-50
E 9018-M	27	-50
E 10018-M	27	-50
E 11018-M	27	-50
E 12018-M	27	-50
E 12018-M1	67	-20
E 7018-W1	27	-20
E 8018-W2	27	-20
E 8016-C1	27	-60
E 8018-C1	27	-60
E 7015-C1L	27	-75
E 7016-C1L	27	-75
E 7018-C1L	27	-75
E 8016-C2	27	-75
E 8018-C2	27	-75
E 7015-C2L	27	-100
E 7016-C2L	27	-100
E 7018-C2L	27	-100
E 9015-C5L	27	-115
E XXXX-A1/BX/BXL	Not spec.	Not spec.
E(X)X XX-G	Not spec.	Not spec.

Suffix	Alloying system	Nominal values, wt%
-A1	C / Mo	~0.1/ 0,4-0,65
-B1	Cr / Mo	0.40-0.65 ~0.5/ 0,4-0,65
-B2	Cr / Mo	~1.3/ 0,4-0,65
-B2L*	Cr / Mo	~1.3/ 0,4-0,65
-B3	Cr / Mo	~2.3/ 0.90-1.20
-B3L*	Cr / Mo	~2.3/ 0.90-1.20
-B4L*	Cr / Mo	~2.0/ 0,4-0,65
-B5	Cr / Mo / V	~0.5 / 1.0 / 0.05
-C1	Ni	~2.5
-C1L*	Ni	~2.5
-C2	Ni	~3.5
-C2L*	Ni	~3.5
-C3	Ni / Cr / Mo / V	~1.0 / 0.1 / 0.3 / 0.05
-NM	Ni / Mo	~1.0/ 0.5
-D1	Mn / Mo	~1.5/ 0.3
-D2	Mn / Mo	~1.8/ 0.3
-D3	Mn / Mo	~1.5/ 0.5
-G/-M/-W	All other low alloy steel electrodes	

## GUIDE TO AWS A5.5: ELECTRODES FOR LOW-ALLOY STEEL FOR SHIELDED METAL ARC WELDING

E	80	16	D3
---	----	----	----

Detailed information about the analysis												
A5.4	A5.4M	UNS	C	Mn	Si	P	S	Ni	Cr	Mo	Additional Elements	
											Type	Amt.
<b>Carbon-Molybdenum Steel Electrodes</b>												
E7010-A1	E4910-A1	W17010	0,12	0,60	0,40	0,03	0,03	-	-	0.40-0.65	-	-
E7011-A1	E4911-A1	W17011	0,12	0,60	0,40	0,03	0,03	-	-	0.40-0.65	-	-
E7015-A1	E4915-A1	W17015	0,12	0,90	0,60	0,03	0,03	-	-	0.40-0.65	-	-
E7016-A1	E4916-A1	W17016	0,12	0,90	0,60	0,03	0,03	-	-	0.40-0.65	-	-
E7018-A1	E4918-A1	W17018	0,12	0,90	0,80	0,03	0,03	-	-	0.40-0.65	-	-
E7020-A1	E4920-A1	W17020	0,12	0,60	0,40	0,03	0,03	-	-	0.40-0.65	-	-
E7027-A1	E4927-A1	W17027	0,12	1,00	0,40	0,03	0,03	-	-	0.40-0.65	-	-
<b>Chromium-Molybdenum Steel Electrodes</b>												
E8016-B1	E5516-B1	W51016	0.05-0.12	0.90	0.60	0.03	0.03	-	0.40-0.65	0.40-0.65	-	-
E8018-B1	E5518-B1	W51018	0.05-0.12	0.90	0.80	0.03	0.03	-	0.40-0.65	0.40-0.65	-	-
E8016-B2	E5516-B2	W52016	0.05-0.12	0.90	0.60	0.03	0.03	-	1.00-1.50	0.40-0.65	-	-
E8018-B3	E5518-B3	W52018	0.05-0.12	0.90	0.80	0.03	0.03	-	1.00-1.50	0.40-0.65	-	-
E7015-B2L	E4915-B2L	W52115	0.05	0.90	1.00	0.03	0.03	-	1.00-1.50	0.40-0.65	-	-
E7016-B2L	E4916-B2L	W52116	0.05	0.90	0.60	0.03	0.03	-	1.00-1.50	0.40-0.65	-	-
E7018-B2L	E4918-B2L	W52118	0.05	0.90	0.80	0.03	0.03	-	1.00-1.50	0.40-0.65	-	-
E9015-B3	E6215-B3	W53115	0.05-0.12	0.90	1.00	0.03	0.03	-	2.00-2.50	0.90-1.20	-	-
E9016-B3	E6216-B3	W53116	0.05-0.12	0.90	0.60	0.03	0.03	-	2.00-2.50	0.90-1.20	-	-
E9018-B3	E6218-B3	W53118	0.05-0.12	0.90	0.80	0.03	0.03	-	2.00-2.50	0.90-1.20	-	-
E8015-B3L	E5515-B3L	W53115	0.05	0.90	1.00	0.03	0.03	-	0.90-1.20	0.90-1.20	-	-
E8018-B3L	E5518-B3L	W53118	0.05	0.90	0.80	0.03	0.03	-	0.90-1.20	0.90-1.20	-	-
E8015-B4L	E5515-B4L	W53415	0.05	0.90	1.00	0.03	0.03	-	1.75-2.25	0.40-0.65	-	-
E8016-B5	E5516-B5	W51316	0.07-0.15	0.40-0.70	0.30-0.60	0.03	0.03	-	0.40-0.60	1.00-1.25	V	0,05
E8015-B6(E)	E5515-B6(E)	W50215	0.05-0.10	1,0	0.90	0.03	0.03	0.40	4.0-6.0	0.45-0.65	-	-
E8016-B6(E)	E5516-B6(E)	W50216	0.05-0.10	1,0	0.90	0.03	0.03	0.40	4.0-6.0	0.45-0.65	-	-
E8018-B6(E)	E5518-B6(E)	W50218	0.05-0.10	1,0	0.90	0.03	0.03	0.40	4.0-6.0	0.45-0.65	-	-
E8015-B6L(E)	E5515-B6L(E)	W50205	0.05	1,0	0.90	0.03	0.03	0.40	4.0-6.0	0.45-0.65	-	-
E8016-B6L(E)	E5516-B6L(E)	W50206	0.05	1,0	0.90	0.03	0.03	0.40	4.0-6.0	0.45-0.65	-	-
E8018-B6L(E)	E5518-B6L(E)	W50208	0.05	1,0	0.90	0.03	0.03	0.40	4.0-6.0	0.45-0.65	-	-
E8015-B7(E)	E5515-B7(E)	W50315	0.05-0.10	1,0	0.90	0.03	0.03	0.40	6.0-8.0	0.45-0.65	-	-
E8016-B7(E)	E5516-B7(E)	W50316	0.05-0.10	1,0	0.90	0.03	0.03	0.40	6.0-8.0	0.45-0.65	-	-
E8018-B7(E)	E5518-B7(E)	W50318	0.05-0.10	1,0	0.90	0.03	0.03	0.40	6.0-8.0	0.45-0.65	-	-
E8015-B7L(E)	E5515-B7L(E)	W50305	0.05	1,0	0.90	0.03	0.03	0.40	6.0-8.0	0.45-0.65	-	-
E8016-B7L(E)	E5516-B7L(E)	W50306	0.05	1,0	0.90	0.03	0.03	0.40	6.0-8.0	0.45-0.65	-	-
E8018-B7L(E)	E5518-B7L(E)	W50308	0.05	1,0	0.90	0.03	0.03	0.40	6.0-8.0	0.45-0.65	-	-
E8015-B8(E)	E5515-B8(E)	W50415	0.05-0.10	1,0	0.90	0.03	0.03	0.40	8.0-10.5	0.85-1.20	-	-
E8016-B8(E)	E5516-B8(E)	W50416	0.05-0.10	1,0	0.90	0.03	0.03	0.40	8.0-10.5	0.85-1.20	-	-
E8018-B8(E)	E5518-B8(E)	W50418	0.05-0.10	1,0	0.90	0.03	0.03	0.40	8.0-10.5	0.85-1.20	-	-
E8015-B8L(E)	E5515-B8L(E)	W50405	0.05	1,0	0.90	0.03	0.03	0.40	8.0-10.5	0.85-1.20	-	-
E8016-B8L(E)	E5516-B8L(E)	W50406	0.05	1,0	0.90	0.03	0.03	0.40	8.0-10.5	0.85-1.20	-	-
E8018-B8L(E)	E5518-B8L(E)	W50408	0.05	1,0	0.90	0.03	0.03	0.40	8.0-10.5	0.85-1.20	-	-
E9015-B9(J)	E6215-B9(J)	W50425	0,08-0,13	1,20	0,30	0,01	0,01	0,80	8.0-10.5	0.85-1.20	V Cu Al Nb(Cb) N	0.15-0.30 0,25 0,04 0,02-0,10 0,02-0,07
E9016-B9(J)	E6216-B9(J)	W50426	0,08-0,13	1,20	0,30	0,01	0,01	0,80	8.0-10.5	0.85-1.20	V Cu Al Nb(Cb) N	0.15-0.30 0,25 0,04 0,02-0,10 0,02-0,07
E9018-B9(J)	E6218-B9(J)	W50428	0,08-0,13	1,20	0,30	0,01	0,01	0,80	8.0-10.5	0.85-1.20	V Cu Al Nb(Cb) N	0.15-0.30 0,25 0,04 0,02-0,10 0,02-0,07
<b>Nickel Steel Electrodes</b>												
E8016-C1	E5516-C1	W22016	0,12	1,25	0,60	0,03	0,03	2.00-2.75	-	-	-	-
E8018-C1	E5518-C1	W22018	0,12	1,25	0,60	0,03	0,03	2.00-2.75	-	-	-	-
E7015-C1L	E4915-C1L	W22115	0.05	1,25	0,50	0,03	0,03	2.00-2.75	-	-	-	-
E7016-C1L	E4916-C1L	W22116	0.05	1,25	0,50	0,03	0,03	2.00-2.75	-	-	-	-
E7018-C1L	E4918-C1L	W22118	0.05	1,25	0,50	0,03	0,03	2.00-2.75	-	-	-	-

## GUIDE TO AWS A5.5: ELECTRODES FOR LOW-ALLOY STEEL FOR SHIELDED METAL ARC WELDING

E	80	16	D3
---	----	----	----

## Detailed information about the analysis

A5.5	A5.5M	UNS	C	Mn	Si	P	S	Ni	Cr	Mo	Additional Elements	
											Type	Amt.
E8016-C2	E5516-C2	W23016	0,12	1,25	0,60	0,03	0,03	3,00-3,75	-	-	-	-
E8018-C2	E5518-C2	W23018	0,12	1,25	0,80	0,03	0,03	3,00-3,75	-	-	-	-
E7015-C2L	E4915-C2L	W23115	0,05	1,25	0,50	0,03	0,03	3,00-3,75	-	-	-	-
E7016-C2L	E4916-C2L	W23116	0,05	1,25	0,50	0,03	0,03	3,00-3,75	-	-	-	-
E7018-C2L	E4918-C2L	W23118	0,05	1,25	0,50	0,03	0,03	3,00-3,75	-	-	-	-
E8016-C3	E5516-C3	W21016	0,12	0,40-1,25	0,80	0,03	0,03	0,80-1,10	0,15	0,35	V	0,05
E8018-C3	E5518-C3	W21018	0,12	0,40-1,25	0,80	0,03	0,03	0,80-1,10	0,15	0,35	V	0,05
E7018-C3L	E4918-C3L	W20918	0,08	0,40-1,40	0,50	0,03	0,03	0,80-1,10	0,15	0,35	V	0,05
E8016-C4	E5516-C4	W21916	0,10	1,25	0,60	0,03	0,03	1,10-2,00	-	-	-	-
E8018-C4	E5518-C4	W21918	0,10	1,25	0,80	0,03	0,03	1,10-2,00	-	-	-	-
E9015-C5L	E6215-C5L	W25018	0,05	0,40-1,00	0,05	0,03	0,03	6,00-7,25	-	-	-	-
<b>Nickel-Molybdenum Steel Electrodes</b>												
E8018-NM1	E5518-NM1	W21118	0,10	0,80-1,25	0,60	0,02	0,02	0,80-1,10	0,10	0,40-0,65	V Cu Al	0,02 0,10 0,05
<b>Manganese-Molybdenum Steel Electrodes</b>												
E8018-D1	E5518-D1	W18118	0,12	1,00-1,75		0,03	0,03	0,90	-	0,25-0,45	-	-
E9015-D1	E5515-D1	W19015	0,12	1,00-1,75		0,03	0,03	0,90	-	0,25-0,45	-	-
E9018-D1	E6218-D1	W19018	0,12	1,00-1,75		0,03	0,03	0,90	-	0,25-0,45	-	-
E10015-D2	E6915-D2	W10015	0,15	1,65-2,00		0,03	0,03	0,90	-	0,25-0,45	-	-
E10016-D2	E6916-D2	W10016	0,15	1,65-2,00		0,03	0,03	0,90	-	0,25-0,45	-	-
E10018-D2	E6918-D2	W10018	0,15	1,65-2,00		0,03	0,03	0,90	-	0,25-0,45	-	-
E8018-D3	E5518-D3	W18016	0,12	1,00-1,80		0,03	0,03	0,90	-	0,25-0,65	-	-
E9015-D3	E6215-D3	W18016	0,12	1,00-1,80		0,03	0,03	0,90	-	0,25-0,65	-	-
E9018-D3	E6218-D3	W19118	0,12	1,00-1,80		0,03	0,03	0,90	-	0,25-0,65	-	-
<b>General Low-Alloy Steel Electrodes</b>												
E(X)XX10-G(F)	EXX10-G(F)	-	-	1,00 min. (G)	0,80 min. (G)	0,03	0,03	0,50 min. (G)	0,30 min. (G)	0,20 min. (G)	V Cu	0,10 min. (G) 0,20 min.(G)
E(X)XX11-G(F)	EXX11-G(F)	-	-									
E(X)XX13-G(F)	EXX13-G(F)	-	-									
E(X)XX15-G(F)	EXX15-G(F)	-	-									
E(X)XX16-G(F)	EXX16-G(F)	-	-									
E(X)XX18-G(F)	EXX18-G(F)	-	-									
E7020-G	E4920-G	-	-									
E7027-G	E4927-G	-	-									
<b>Military-Similar Electrodes</b>												
E9018M(H)	E6218M(H)	W21218	0,10	0,60-1,25	0,80	0,03	0,03	1,40-1,80	0,15	0,35	V	0,05
E10018M(H)	E6918M(H)	W21318	0,10	0,75-1,70	0,60	0,03	0,03	1,40-2,10	0,35	0,25-0,50	V	0,05
E11018M(H)	E7618M(H)	W21418	0,10	1,30-1,80	0,60	0,03	0,03	1,25-2,50	0,40	0,25-0,50	V	0,05
E12018M(H)	E8318M(H)	W22218	0,10	1,30-2,25	0,60	0,03	0,03	1,75-2,50	0,30-1,50	0,30-0,55	V	0,05
E12018M1(H)	E8318M1(H)	W23218	0,10	0,80-1,60	0,65	0,015	0,012	3,00-3,80	0,65	0,20-0,30	V	0,05
<b>Pipeline Electrodes</b>												
E7010-P1	E4910-P1	W17110	0,20	1,20	0,60	0,03	0,03	1,0	0,30	0,50	V	0,10
E8010-P1	E5510-P1	W18110	0,20	1,20	0,60	0,03	0,03	1,0	0,30	0,50	V	0,10
E9010-P1	E6210-P1	W19110	0,20	1,20	0,60	0,03	0,03	1,0	0,30	0,50	V	0,10
E8018-P2	E5518-P2	W18218	0,12	0,90-1,70	0,80	0,03	0,03	1,0	0,20	0,50	V	0,05
E9018-P2	E6218-P2	W19218	0,12	0,90-1,70	0,80	0,03	0,03	1,0	0,20	0,50	V	0,05
E8045-P2	E5545-P2	W18245	0,12	0,90-1,70	0,80	0,03	0,03	1,0	0,20	0,50	V	0,05
E9045-P2	E6245-P2	W19245	0,12	0,90-1,70	0,80	0,03	0,03	1,0	0,20	0,50	V	0,05
E10045-P2	E6945-P2	W10245	0,12	0,90-1,70	0,80	0,03	0,03	1,0	0,20	0,50	V	0,05
<b>Weathering Steel Electrodes</b>												
E7018-W1(l)	E6945-P2	W20018	0,12	0,40-0,70	0,40-0,70	0,025	0,025	0,20-0,40	0,15-0,30	--	V / Cu	0,08 / 0,30-0,60
E8018-W2(l)	E5518-W2	W20118	0,12	0,50-1,30	0,35-0,80	0,03	0,03	0,40-0,80	0,45-0,70	--	V	0,30-0,75

## GUIDE TO AWS A5.5: ELECTRODES FOR LOW-ALLOY STEEL FOR SHIELDED METAL ARC WELDING

COMPARISON OF EQUIVALENT CLASSIFICATIONS							
ISO						AWS	
2560A(B)	2560B(B)	3580A(C)	3580B(C)	18275A(D)	18275B(D)	A5.5	A5.5M
<b>Carbon-Molybdenum Steel Electrodes</b>							
E38xMo	E49xx-1M3	EMo x	E49xx-MM3			E70xx-A1	E49xx-A1
<b>Manganese-Molybdenum Steel Electrodes</b>							
	E55xx-3M2					E80xx-D1	E55xx-D1
					E69xx-4M2	E100xx-D2	E69xx-D2
				E550xMnMo	E62xx-3M3	E90xx-D3	E62xx-D3
<b>Chromium-Molybdenum Steel Electrodes</b>							
		ECrMo0.5	E55xx-CM			E80xx-B1	E55xx-B1
		ECrMo1	E55xx-1CM			E80xx-B2	E55xx-B2
		ECrMo1L	E55xx-1CML			E70xx-B2L	E49xx-B2L
		ECrMo2	E62xx-2C1M			E90xx-B3	E62xx-B3
		ECrMo2L	E55xx-2C1ML			E80xx-B3L	E55xx-B3L
			E55xx-2CM1L			E80xx-B4L	E55xx-B4L
			E55xx-C1M			E80xx-B5	E55xx-B5
		ECrMo5	E55xx-5CM			E80xx-B6	E55xx-B6
			E55xx-5CML			E80xx-B6	E55xx-B6L
			E55xx-7CM			E80xx-B7	E55xx-B7
			E55xx-7CML			E80xx-B7L	E55xx-B7L
		ECrMo9	E55xx-9C1M			E80xx-B8	E55xx-B8
			E55xx-9C1ML			E80xx-B8L	E55xx-B8L
		ECrMo91	E62xx-9C1MV			E90xx-B9	E62xx-B9
<b>Nickel Steel Electrodes</b>							
	E55xx-N5					E80xx-C1	E55xx-C1
	E49xx-N5					E70xx-C1L	E49xx-C1L
	E55xx-N7					E80xx-C2	E55xx-C2
E38x1Ni E	E49xx-N7					E70xx-C2L	E49xx-C2L
	E55xx-N2					E80xx-C3	E55xx-C3
	E49xx-N2					E70xx-C3L	E49xx-C3L
	E55xx-N3					E80xx-C4	E55xx-C4
	E62125-N13L					E90xx-C5L	E62xx-C5L
<b>Nickel-Molybdenum Steel Electrodes</b>							
E38x1NiMo	E55xx-N2M3					E80xx-NM1	E55xx-NM1
<b>Military-Similar Electrodes</b>							
E550x1,5NiMo	E6218-N3M1					E9018M	E6218M
	E6918-N3M2					E10018M	E6918M
				E69xMn2NiCrMo	E7618-N4CM2	E11018M	E7618M
				E69xMn2Ni1CrMo	E8318-N4C2M2	E12018M	E8318M
						E12018M1	E8318M1
<b>Weathering Steel Electrodes</b>							
	E49xx-NCC2					E7018-W1	E4918-W1
	E5518-NCC1					E8018-W2	E5518-W2

**NOTES:**

(A) The requirements for the equivalent classifications shown are not necessarily identical in every aspect.

(B) ISO 2560, Welding consumables - Covered electrodes for manual metal arc welding of nonalloy and fine grain steels - Classification.

(C) ISO 3580, Welding consumables - Covered electrodes for manual metal arc welding of creep-resisting steels - Classification.

(D) ISO 18275, Welding consumables - Covered electrodes for manual metal arc welding of high tensile steels - Classification



## GUIDE TO AWS A5.6: COPPER AND COPPER-ALLOY ELECTRODES FOR SHIELDED METAL ARC WELDING

## GUIDE TO AWS A5.7: SPECIFICATION FOR COPPER AND COPPER-ALLOY BARE WELDING RODS AND ELECTRODES

E = Covered electrode for manual metal arc

ER = Bare welding Rods and Electrodes

E / ER    RCu

Alloy type	UNS Number	Common Name	Composition, Weight Percent a) b)											
			Cu (+Ag)	Zn	Sn	Mn	Fe	Si	Ni(+Co)	P	Al	Pb	Ti	andere
ERCu	C18980	Copper	98.0 min	-	1.0	0.50	-	0.50	-	0.15	0.01	0.02	-	0.50
ERCuSi-A	C65600	Silicon bronze (copper-silicon)	Rem	1.0	1.0	1.5	0.50	2.8– 4.0	-	-	0.01	0.02	-	0.50
ERCuSn-A	C51800	Phosphor bronze (copper-tin)	Rem	-	4.0-6.0	-	-	-	-	0.10– 0.35	0.01	0.02	-	0.50
ERCuSn-C	C52100	Phosphor bronze (copper-tin)	Rem	0.20	7.0- 9.0	-	0.10	-	-	0.10– 0.35	0.01	0.02	-	0.50
ERCuNi-d	C71581	Copper-nickel	Rem	-	-	1.0	0.40– 0.75	0.25	29.0– 32.0	0.02	-	0.02	0.20-0.50	0.50
ERCuAl-A1	C61000	Aluminum bronze	Rem	0.20	-	0.50	-	0.10	-	--	6.0– 8.5	0.02	-	0.50
ERCuAl-A2	C61800	Aluminum bronze	Rem	0.20	-	-	1.5	0.10	-	-	8.5– 11.0	0.02	-	0.50
ERCuAl-A3	C62400	Aluminum bronze	Rem	0.10	-	-	2.0– 4.5	0.10	-	-	10.0– 11.5	0.02	-	0.50
ERCuNiAl	C63280	Nickel-aluminum bronze	Rem	0.10	-	0.60– 3.50	3.0– 5.0	0.10	4.0– 5.5	-	8.50– 9.50	0.02	-	0.50
ERCuMnNiAl	C63380	Manganese-nickel aluminum bronze	Rem	0.15	-	11.0– 14.0	2.0– 4.0	0.10	1.5– 3.0	-	7.0– 8.5	0.02	-	0.50

**NOTES:**

- a) Analysis shall be made for the elements for which specific values are shown in this table. If, however, the presence of other elements is indicated in the course of routine analysis, further analysis shall be made to determine that the total of these other elements is not present in excess of the limits specified for 'Total other elements' in the last column in this table.
- b) Single values shown are maximum, unless otherwise noted.
- c) ASTM DS-56/SAE HS-1086, Metals & Alloys in the Unified Numbering System.
- d) Sulfur shall be 0.01% maximum for the ERCuNi classification.
- e) Ag may or may not be present.
- f) Co may or may not be present.

## GUIDE TO AWS A5.6: COPPER AND COPPER-ALLOY ELECTRODES FOR SHIELDED METAL ARC WELDING

## GUIDE TO AWS A5.7: SPECIFICATION FOR COPPER AND COPPER-ALLOY BARE WELDING RODS AND ELECTRODES

E = Covered electrode for manual metal arc

ER = Bare welding Rods and Electrodes

E / ER

RCu

Chemical composition symbols for classification according to		Chemical composition, % b) c)																	
numerical	chemical	AWS 5.6/5.7	UNS	Cu	Al	Fe	Mn	Ni+Co	P	Pb	Si	Sn	Zn	As	C	Ti	S	Other elements	
<b>COPPER LOW ALLOYED</b>																			
Cu 1897	CuAg1	-	C18970	≥ 99,5+Ag	0,01	0,05	0,2	0,3	0,01-0,05	0,01	0,1	--	--	0,05	--	--	--	0,2 Ag 0,8-1,2	
Cu 1898	CuSn1	ERCu	C18980	≥ 98,0	0,01	--	0,50	--	0,15	0,02	0,5	1,0	--	--	--	--	--	0,50	
Cu 1898A	CuSn1MnSi	-	C18980	Rem	0,01	0,03	0,1-0,4	0,1	0,015	0,01	0,1-0,4	0,5-1,0	--	--	--	--	--	0,2	
<b>COPPER-SILICON (SILICON BRONZE)</b>																			
Cu 6511	CuSi2Mn1	-	C65110	Rem	0,01	0,1	0,5-1,5	--	0,02	0,02	1,5-2,0	0,1-0,3	0,2	--	--	--	--	0,5	
Cu 6560	CuSi3Mn1	ERCuSi-A	C65600	Rem	0,02	0,5	0,5-1,5	--	0,05	0,02	2,8-4,0	0,2	0,4	--	--	--	--	0,5	
Cu 6561	CuSi2Mn1Sn1Zn	-	C65610	Rem	--	0,5	1,5	--	--	0,02	2,0-2,8	1,5	1,5	--	--	--	--	0,5	
<b>COPPER TIN (including PHOSPHORICAL BRONZE)</b>																			
Cu 5180	CuSn5P	ERCuSn-A	C51800	Rem	0,01	--	--	--	0,1-0,4	0,02	--	4,0-6,0	--	--	--	--	--	0,5	
Cu 5180A	CuSn6P	ERCuSn-A	C51800	Rem	0,01	0,1	--	--	0,01-0,4	0,02	--	4,0-7,0	--	--	--	--	--	0,2	
Cu 5210	CuSn8P	ERCuSn-C	C52100	Rem	--	0,1	--	0,2	0,01-0,4	0,02	--	7,5-8,5	--	--	--	--	--	0,2	
Cu 5211	CuSn10MnSi	-	C52110	Rem	0,01	0,1	0,1-0,5	--	0,1	0,02	0,1-0,5	9,0-10,0	--	--	--	--	--	0,5	
Cu 5410	CuSn12P	-	C54100	Rem	0,005	--	--	--	0,01-0,4	0,02	--	11,0-13,0	--	--	--	--	--	0,4	
<b>COPPER-ZINC (BRASS)</b>																			
Cu 4641	CuZn40SnSi	-	C45410	58,0-62,0	0,01	0,2	0,3	--	--	0,03	0,1-0,5	1,0	rest	--	--	--	--	0,2	
Cu 4700	CuZn40Sn	RBCuZn-A	C47000	57,0-61,0	0,01 c	c	c	--	--	0,05 c	c	0,25-1,00	rest	--	--	--	--	0,5 c	
Cu 4701	CuZn40SnSiMn	-	C47010	58,5-61,5	0,01	0,25	0,05-0,25	--	--	0,02	0,15-0,40	0,2-0,5	rest	--	--	--	--	0,2	
Cu 6800	CuZn40Ni	RBCuZn-B	C68000	56,0-60,0	0,01 c	0,25-1,20	0,01-0,50	0,2-0,8	--	0,05 c	0,04-0,20	0,8-1,1	rest	--	--	--	--	0,5 c	
Cu 6810	CuZn40Fe1Sn1	RBCuZn-C	C68100	59,0-60,0	0,01 c	0,25-1,20	0,01-0,50	--	--	0,05 c	0,04-0,15	0,8-1,1	rest	--	--	--	--	0,5 c	
Cu 7730	CuZn40Ni10	RBCuZn-D	C77300	46,0-50,0	0,01	--	--	9,0-11,0	0,25	0,05 c	0,04-0,25	--	rest	--	--	--	--	0,5 c	
<b>COPPER-ALUMINIUM (ALUMINIUM BRONZE)</b>																			
Cu 6061	CuAl5Ni2Mn	-	C60510	Rem	4,5-5,5	0,5	0,1-1,0	1,0-2,5	--	0,02	0,1	--	0,2	--	--	--	--	0,5	
Cu 6100	CuAl7	ERCuAl-A1	C61000	Rem	6,0-8,5	c	0,5	c	--	0,02	0,2	c	0,2	--	--	--	--	0,4 c	
Cu 6180	CuAl10Fe	ERCuAl-A2	C61800	Rem	8,5-11,0	1,5	--	--	--	0,02	0,1	--	0,02	--	--	--	--	0,5	
Cu 6240	CuAl11Fe3	ERCuAl-A3	C62400	Rem	10,0-11,5	2,0-4,5	--	--	--	0,02	0,1	--	0,1	--	--	--	--	0,5	
Cu 6325	CuAl8Fe4Mn2Ni2	-	C63250	Rem	7,0-9,0	1,8-5,0	0,5-3,0	0,5-3,0	--	0,02	0,1	--	0,1	--	--	--	--	0,4	
Cu 6327	CuAl8Ni2Fe2Mn2	-	C63270	Rem	7,0-9,5	0,5-2,5	0,5-2,5	0,5-3,0	--	0,02	0,2	--	0,2	--	--	--	--	0,4	
Cu 6328	CuAl9Ni5Fe3Mn2	ERCuNiAl	C63280	Rem	8,5-9,5	3,0-5,0	0,6-3,5	4,0-5,5	--	0,02	0,1	--	0,1	--	--	--	--	0,5	
<b>COPPER MANGANESE</b>																			
Cu 6338	CuMn13Al8Fe3Ni2	ERCuMnNiAl	C63380	Rem	7,0-8,5	2,0-4,0	11,0-14,0	1,5-3,0	--	0,02	0,1	--	0,15	--	--	--	--	0,5	
<b>COPPER NICKEL</b>																			
Cu 7061	CuNi10	-	C70610	Rem	--	0,5-2,0	0,5-1,5	9,0-11,0	0,02	0,02	0,2	--	--	--	0,05	0,1-0,5	0,02	0,4	
Cu 7158	CuNi30Mn1FeTi	ERCuNi	C71581	Rem	--	0,4-0,7	0,5-1,5	29,0-32,0	0,02	0,02	0,25	--	--	--	0,04	0,2-0,5	0,01	0,5	

a) The elements for which specific values are given in this table shall be analyzed. However, if the analysis carried out in accordance with the rules provides evidence of the presence of other elements, the table shall be replaced by an additional analysis to show that the sum of these other elements does not exceed the declared maximum level.

b) Single values are maxima, unless otherwise noted.

c) The sum of all other elements, including those for which a maximum value or an asterisk is indicated, shall not exceed the value indicated in ,Other sum

GUIDE TO AWS A5.8: FILLER METALS FOR BRAZING AND BRAZE WELDING

Brazing filler metals are standardized into seven classifications as follows: silver Ag, gold Au, aluminum Al, copper Cu, nickel Ni, cobalt Co, and magnesium Mg filler metals.

R = welding rods  
 E = electrodes  
 B = brazing filler metal  
 V = brazing filler metals for vacuum service

**RB(V) Ag-37**

CHEMICAL COMPOSITION REQUIREMENTS FOR SILVER FILLER METALS

Code AWS	Code ISO	Ag min./max	Cu min./max	Zn min./max	Cd min./max	Sn min./max	Si min./max	Ni min./max	Mn min./max	Melting temperature (approximate)	
										Solidus °C	Liquidus °C
<b>Ag-Cu-Zn-Sn alloys</b>											
B <del>Ag</del> -37	Ag 125	24,0/26,0	39,0/41,0	31,0/35,0	—/0,010	1,5/2,5	—/0,05	—/—	—/—	680	760
	Ag 130	29,0/31,0	35,0/37,0	30,0/34,0	—/0,010	1,5/2,5	—/0,05	—/—	—/—	665	755
	Ag 134	33,0/35,0	35,0/37,0	25,5/29,5	—/0,010	2,0/3,0	—/0,05	—/—	—/—	630	730
B <del>Ag</del> -34	Ag 138	37,0/39,0	31,0/33,0	26,0/30,0	—/0,010	1,5/2,5	—/0,05	—/—	—/—	650	720
B <del>Ag</del> -28	Ag 140	39,0/41,0	29,0/31,0	26,0/30,0	—/0,010	1,5/2,5	—/0,05	—/—	—/—	650	710
B <del>Ag</del> -36	Ag 145	44,0/46,0	26,0/28,0	23,5/27,5	—/0,010	2,0/3,0	—/0,05	—/—	—/—	640	680
	Ag 155	54,0/56,0	20,0/22,0	20,0/24,0	—/0,010	1,5/2,5	—/0,05	—/—	—/—	630	660
B <del>Ag</del> -7	Ag 156	55,0/57,0	21,0/23,0	15,0/19,0	—/0,010	4,5/5,5	—/0,05	—/—	—/—	620	655
B <del>Ag</del> -18	Ag 160	59,0/61,0	29,0/31,0	—/—	—/0,010	9,5/10,5	—/0,05	—/—	—/—	600	730
<b>Ag-Cu-Zn alloys</b>											
	Ag 205	4,0/6,0	54,0/56,0	38,0/42,0	—/0,010	—/—	0,05/0,25	—/—	—/—	820	870
	Ag 212	11,0/13,0	47,0/49,0	38,0/42,0	—/0,010	—/—	0,05/0,25	—/—	—/—	800	830
	Ag 225	24,0/26,0	39,0/41,0	33,0/37,0	—/0,010	—/—	—/0,05	—/—	—/—	700	790
B <del>Ag</del> -20	Ag 230	29,0/31,0	37,0/39,0	30,0/34,0	—/0,010	—/—	—/0,05	—/—	—/—	680	765
B <del>Ag</del> -35	Ag 235	34,0/36,0	31,0/33,0	31,0/35,0	—/0,010	—/—	—/0,05	—/—	—/—	685	755
	Ag 244	43,0/45,0	29,0/31,0	24,0/28,0	—/0,010	—/—	—/0,05	—/—	—/—	675	735
B <del>Ag</del> -5	Ag 245	44,0/46,0	29,0/31,0	23,0/27,0	—/0,010	—/—	—/0,05	—/—	—/—	665	745
B <del>Ag</del> -6	Ag 250	49,0/51,0	33,0/35,0	14,0/18,0	—/0,010	—/—	—/0,05	—/—	—/—	690	775
B <del>Ag</del> -9	Ag 265	64,0/66,0	19,0/21,0	13,0/17,0	—/0,010	—/—	—/0,05	—/—	—/—	670	720
B <del>Ag</del> -10	Ag 270	69,0/71,0	19,0/21,0	8,0/12,0	—/0,010	—/—	—/0,05	—/—	—/—	690	740
B <del>Ag</del> -8	Ag 272a	71,0/73,0	27,0/29,0	—/—	—/0,010	—/—	—/0,05	—/—	—/—	780	780
<b>Ag-Cu-Zn-Cd alloys</b>											
B <del>Ag</del> -33	Ag 326	24,0/26,0	29,0/31,0	25,5/29,5	16,5/18,5	—/—	—/0,05	—/—	—/—	605	720
	Ag 330	29,0/31,0	27,0/29,0	19,0/23,0	19,0/23,0	—/—	—/0,05	—/—	—/—	600	690
B <del>Ag</del> -2	Ag 335	34,0/36,0	25,0/27,0	19,0/23,0	17,0/19,0	—/—	—/0,05	—/—	—/—	605	700
	Ag 340	39,0/41,0	18,0/20,0	19,0/23,0	18,0/22,0	—/—	—/0,05	—/—	—/—	595	630
B <del>Ag</del> -1	Ag 345	44,0/46,0	14,0/16,0	14,0/18,0	23,0/25,0	—/—	—/0,05	—/—	—/—	605	620
B <del>Ag</del> -1a	Ag 350	49,0/51,0	14,5/16,5	14,5/18,5	17,0/19,0	—/—	—/0,05	—/—	—/—	625	635
B <del>Ag</del> -3	Ag 351	49,0/51,0	14,5/16,5	13,5/17,5	15,0/17,0	—/—	—/0,05	2,5/3,5	—/—	635	655
<b>Ag-Cu-Zn-Ni-Mn alloys</b>											
B <del>Ag</del> -26	Ag 425	24,0/26,0	37,0/39,0	31,0/35,0	—/0,010	—/—	—/0,05	1,5/2,5	1,5/2,5	705	800
	Ag 427	26,0/28,0	37,0/39,0	18,0/22,0	—/0,010	—/—	—/0,05	5,0/6,0	8,5/10,5	680	830
B <del>Ag</del> -4	Ag 440	39,0/41,0	29,0/31,0	26,0/30,0	—/0,010	—/—	—/0,05	1,5/2,5	—/—	670	780
B <del>Ag</del> -22	Ag 449	48,0/50,0	15,0/17,0	21,0/25,0	—/0,010	—/—	—/0,05	4,0/5,0	7,0/8,0	680	705
B <del>Ag</del> -24	Ag 450	49,0/51,0	19,0/21,0	26,0/30,0	—/0,010	—/—	—/0,05	1,5/2,5	—/—	660	705
B <del>Ag</del> -13	Ag 454	53,0/55,0	37,5/42,5	4,0/6,0	—/0,010	—/—	—/0,05	0,5/1,5	—/—	720	855
B <del>Ag</del> -13a	Ag 456	55,0/57,0	41,0/43,0	—/—	—/0,010	—/—	—/0,05	1,5/2,5	—/—	770	895
B <del>Ag</del> -21	Ag 463	62,0/64,0	27,5/29,5	—/—	—/0,010	5,0/7,0	—/0,05	2,0/3,0	—/—	690	800
B <del>Ag</del> -23	Ag 485	84,0/86,0	—/—	—/—	—/0,010	—/—	—/0,05	—/—	14,0/16,0	960	970

**B~~Ag~~ Classification (Silver).**  
 Brazing filler metals in the B~~Ag~~ classification are used to join most ferrous and nonferrous metals, except aluminum and magnesium

**NOTE:** Maximum impurity limits applicable to all types are (% by mass) Al 0,001, Bi 0,030, P 0,008, Pb 0,025; total of all impurities = 0,15; total of all impurities for Ag 427, Ag 449 and Ag 485 = 0,30.

## GUIDE TO AWS A5.8: FILLER METALS FOR BRAZING AND BRAZE WELDING

CHEMICAL COMPOSITION REQUIREMENTS FOR GOLD FILLER METALS									
Code AWS	Code ISO	Au	Cu	Ni	Pd	Ag	Andere	Melting temperature (approximate)	
		min./max	min./max	min./max	min./max.	min./max	min./max	Solidus °C	Liquidus °C
	Au 295 a	29,5/30,5	69,5/70,5	—/—	—/—	—/—	—/—	995	1020
BAu-5	Au 300	29,5/30,5	—/—	35,5/36,5	33,5/34,5	—/—	—/—	1135	1165
BAu-3	Au 351	34,5/35,5	61,0/63,0	2,5/3,5	—/—	—/—	—/—	975	1030
BVAu-9	Au 354	34,5/35,5	64,5/65,5	—/—	—/—	—/—	—/—	990	1010
BAu-1	Au 375 a	37,0/38,0	62,0/63,0	—/—	—/—	—/—	—/—	980	1000
BVAu-10	Au 503	49,5/50,5	49,5/50,5	—/—	—/—	—/—	—/—	955	970
BVAu-7	Au 507	49,5/50,5	—/—	24,5/25,5	24,0/26,0	—/—	Co —/0,06	1100	1120
	Au 625 a	62,0/63,0	37,0/38,0	—/—	—/—	—/—	—/—	930	940
BAu-6	Au 700	69,5/70,5	—/—	21,5/22,5	7,5/8,5	—/—	—/—	1005	1045
	Au 752 a	74,5/75,5	—/—	24,5/25,5	—/—	—/—	—/—	950	990
	Au 755	74,5/75,5	11,5/13,5	—/—	—/—	12,0/13,0	—/—	880	895
BAu-2	Au 800	79,5/80,5	19,5/20,5	—/—	—/—	—/—	—/—	890	890
	Au 801 a	79,5/80,5	18,5/19,5	—/—	—/—	—/—	Fe 0,5/1,5	905	910
BAu-4	Au 827 a	81,5/82,5	—/—	17,5/18,5	—/—	—/—	—/—	950	950
BVAu-8	Au 927	91,0/93,0	—/—	—/—	7,0/9,0	—/—	—/—	1200	1240

**NOTE:** Maximum impurity limits applicable to all types are (% by mass) Al 0,0010, Cd 0,010, P 0,008, Pb 0,025, Ti 0,002, Zr 0,002; total of all impurities = 0,15

**BAu Classification (Gold).**

Brazing filler metals in the BAu classification are used for the brazing of iron, nickel, and cobalt base metals when better ductility or a greater resistance to oxidation and corrosion is required

**BAISi Classification (Aluminum-Silicon).**

Brazing filler metals in the BAISi classification are used for joining the following grades of aluminum and aluminum alloys; 1060, 1350, 1100, 3003, 3004, 3005, 5005, 5050, 6053, 6061, 6951, 7005, and cast alloys 710.0 and 711.0

CHEMICAL COMPOSITION REQUIREMENTS FOR ALUMINUM AND MAGNESIUM FILLER METALS															
Code AWS	Code ISO	Si min./max	Fe max.	Cu min./max	Mn max.	Mg min./max	Zn max.	Cd max.	Pb max.	Other min./max	Non-defined elements		Al	Melting temperature (approximate)	
											Each-max.	Total max.		Solidus °C	Liquidus °C
<b>Al-Si alloys</b>															
	Al 105	4,5/6,0	0,6	—/0,30	0,15	—/0,20	0,10	0,010	0,025	Ti: —/0,15	0,05	0,15	Rest	575	630
BAISi-2	Al 107	6,8/8,2	0,8	—/0,25	0,10	—/—	0,20	0,010	0,025	—/—	0,05	0,15	Rest	575	615
BAISi-5	Al 110	9,0/11,0	0,8	—/0,30	0,05	—/0,05	0,10	0,010	0,025	Ti: —/0,20	0,05	0,15	Rest	575	590
BAISi-4	Al 112	11,0/13,0	0,8	—/0,30	0,15	—/0,10	0,20	0,010	0,025	—/—	0,05	0,15	Rest	575	585
<b>Al-Si-Cu alloys</b>															
BAISi-3	Al 210	9,3/10,7	0,8	3,3/4,7	0,15	—/0,15	0,20	0,010	0,025	Cr: —/0,15	0,05	0,15	Rest	520	585
<b>Al-Si-Mg alloys</b>															
BAISi-7	Al 310	9,0/10,5	0,8	—/0,25	0,10	1,0/2,0	0,20	0,010	0,025	—/—	0,05	0,15	Rest	555	590
BAISi-11	Al 311	9,0/10,5	0,8	—/0,25	0,10	1,0/2,0	0,20	0,010	0,025	Bi: 0,02/0,20	0,05	0,15	Rest	555	590
	Al 315	9,0/10,5	0,8	—/0,25	0,10	0,20/1,0	0,20	0,010	0,025	—/—	0,05	0,15	Rest	559	591
BAISi-9	Al 317	11,0/13,0	0,8	—/0,25	0,10	0,10/0,50	0,20	0,010	0,025	—/—	0,05	0,15	Rest	562	582
	Al 319	10,5/13,0	0,8	—/0,25	0,10	1,0/2,0	0,20	0,010	0,025	—/—	0,05	0,15	Rest	559	579
<b>Al-Si-Zn alloys</b>															
	Al 410	9,0/11,0	0,8	—/0,30	0,05	—/0,05	0,50/3,0	0,010	0,025	—/—	0,05	0,15	Rest	576	588
	Al 415	10,5/13,0	0,8	—/0,25	0,10	—/—	0,50/3,0	0,010	0,025	—/—	0,05	0,15	Rest	576	609
<b>Mg alloys</b>															
BMg-1	Mg 001	0,05	0,005	0,05	0,15/1,5	Rest	1,7/2,3	0,010	0,025	Be: 0,0002/0,0008 Ni: —/0,005	0,05	0,30	8,3/9,7	443	599

## GUIDE TO AWS A5.8: FILLER METALS FOR BRAZING AND BRAZE WELDING

CHEMICAL COMPOSITION REQUIREMENTS FOR COPPER, COPPER-ZINC, AND COPPER-PHOSPHORUS FILLER METALS												
Code AWS	Code ISO	Cu (inklusive Ag) min./max	Sn min./max	Ag min./max	Ni min./max.	P min./max	Bi min./max	Al max.	Cu <sub>2</sub> O max.	Total impurity limits (see note) Max.	Melting temperature (approximate)	
											Solidus °C	Liquidus °C
<b>Copper-cuprous oxide</b>												
BCu-2	Cu 087	86,50	—/—	—/—	—/—	—/—	—/—	—	Rest	0,5	1085	1085
BCu-1a	Cu 099	99,0	—/—	—/—	—/—	—/—	—/—	—	Rest	0,3 (excluding O)	1085	1085
<b>Copper (99,9 min.)</b>												
BCu-3	Cu 102	99,95	—/—	—/—	—/—	—/—	—/—	—	—	0,3 (excluding Ag)	1085	1085
BCu-1b	Cu 110	99,90	—/—	—/—	—/—	—/—	—/—	—	—	0,4 (excluding O and Ag)	1085	1085
BCu-1	Cu 141	99,90	—/—	—/—	—/—	—/0,075	—/—	0,01	—	0,060 (excluding Ag, As and Ni)	1085	1085
<b>Cu-Ag alloy</b>												
	Cu 188	Rest	—/—	0,8/1,2	—/—	—/—	—/0,1	—	—	0,3 including (Bi 0,1 max.)	1070	1080
<b>Cu-Ni alloy</b>												
	Cu 168	Rest	—/—	—/—	2,5/3,5	—/—	0,02/0,05	—	—	0,15 (excluding Ag)	1085	1100
<b>Cu-Sn alloys</b>												
	Cu 922	Rest	5,5/7,0	—/—	—/—	0,01/0,40	—/—	—	—	Al 0,005	910	1040
	Cu 925	Rest	11,0/13,0	—/—	—/—	0,01/0,40	—/—	—	—	Zn 0,05, others 0,1; total 0,4	825	990

**NOTE:** Maximum impurity limit applicable to all types are (% by mass) Cd 0,010 and Pb 0,025.

Code AWS	Code ISO	Cu min./max	Zn max.	Sn min./max	Si max.	Mn min./max	Ni max.	Fe max.	P max.	Melting temperature (approximate)	
										Solidus °C	Liquidus °C
RBCuZn-A	Cu 470	57,0/61,0	Rest	0,25/1,0	—/—	—/—	—/—	—/—	—/—	875	895
	Cu 470a	58,5/61,5	Rest	—/—	0,2/0,4	—/—	—/—	—/—	—/—	875	895
	Cu 471	56,0/60,0	Rest	0,2/0,5	0,15/0,2	0,05/0,25	—/—	—/—	—/0,5	870	900
	Cu 670	58,5/61,5	Rest	—/0,2	0,15/0,4	0,05/0,25	—/—	—/—	—/—	870	900
RBCuZn-B	Cu 680	56,0/60,0	Rest	0,8/1,1	0,04/0,15	0,2/0,5	0,2/0,8	0,25/1,2	—/—	870	890
RBCuZn-C	Cu 681	56,0/60,0	Rest	0,8/1,1	0,04/0,15	0,01/0,50	—/—	0,25/1,2	—/—	870	890
RBCuZn-D	Cu 773	46,0/50,0	Rest	—/—	0,04/0,25	—/—	9,0/11,0	—/—	—/0,25	890	920

**NOTE:** Maximum impurity limits applicable to all types are (% by mass) Al 0,01, As 0,01, Bi 0,01, Cd 0,010, Fe 0,25, Pb 0,025, Sb 0,01; total impurities (excluding Fe) 0,2.

#### BCu and RBCuZn Classifications (Copper and Copper-Zinc).

Brazing filler metals in the BCu and RBCuZn classifications are used for joining various ferrous and nonferrous metals. They can also be used with various brazing processes. However, with the RBCuZn filler metals, overheating should be avoided. Voids may be formed in the joint by entrapped zinc vapors.

## GUIDE TO AWS A5.8: FILLER METALS FOR BRAZING AND BRAZE WELDING

CHEMICAL COMPOSITION REQUIREMENTS FOR COPPER, COPPER-ZINC, AND COPPER-PHOSPHORUS FILLER METALS								
Code AWS	Code ISO	Cu min./max	P min./max	Ag min./max	Andere min./max	Melting temperature (approximate)		Indicative minimum brazing temperature °C
						Solidus °C	Liquidus °C	
<b>CuP alloys</b>								
	CuP 178	Rest	4,8/5,3	—/—	—/—	710	925	790
	CuP 179	Rest	5,9/6,5	—/—	—/—	710	890	760
	CuP 180	Rest	6,6/7,4	—/—	—/—	710	820	730
BCuP-2	CuP 181	Rest	7,0/7,5	—/—	—/—	710	793	730
	CuP 182	Rest	7,5/8,1	—/—	—/—	710	770	720
<b>Ag-CuP alloys</b>								
	CuP 279	Rest	5,9/6,7	1,5/2,5	—/—	645	825	740
BCuP-6	CuP 280	Rest	6,8/7,2	1,8/2,2	—/—	643	788	740
BCuP-3	CuP 281	Rest	5,8/6,2	4,8/5,2	—/—	645	815	710
BCuP-7	CuP 282	Rest	6,5/7,0	4,8/5,2	—/—	643	771	710
BCuP-4	CuP 283	Rest	7,0/7,5	5,8/6,2	—/—	643	813	720
	CuP 283a	Rest	7,0/7,5	5,8/6,2	Ni 0,05/0,15	643	813	720
BCuP-5	CuP 284	Rest	4,8/5,2	14,5/15,5	—/—	645	800	700
BCuP-8	CuP 285	Rest	6,0/6,7	17,2/18,0	—/—	643	666	670
	CuP 286	Rest	6,6/7,5	17,0/19,0	—/—	645	645	650
<b>CuSn-Si-Sb alloys</b>								
BCuP-9	CuP 385	Rest	6,0/7,0	—/—	Sn 6,0/7,0 Si 0,01/0,4	635	675	645
	CuP 386	Rest	6,4/7,2	—/—	Sn 6,5/7,5	650	700	700
	CuP 389	Rest	5,6/6,4	—/—	Sb 1,8/2,2	690	825	740

**NOTE 1:** Maximum impurity limits applicable to all types are (% by mass) Al 0,01, Bi 0,030, Cd 0,010, Pb 0,025, Zn 0,05, Zn + Cd 0,05; total of all impurities = 0,25.

**NOTE 2:** These filler metals should never be used on ferrous metals, nickel alloys or copper alloys containing nickel

**BCuP Classification (Copper-Phosphorus)**

Brazing filler metals in the BCuP classification are used primarily for joining copper and copper alloys, although they have some limited use on silver, tungsten, and molybdenum. These filler metals should not be used on ferrous or nickel-based alloys or on copper-nickel alloys containing a nickel content in excess of 10%.

## GUIDE TO AWS A5.8: FILLER METALS FOR BRAZING AND BRAZE WELDING

**BNi Classification (Nickel).**

Brazing filler metals in the BNi classification are generally used for their corrosion-resistant and heat-resistant properties

CHEMICAL COMPOSITION REQUIREMENTS FOR NICKEL AND COBALT FILLER METALS																	
Code AWS	Code ISO	Ni min./max	Co min./max	Cr min./max	Si min./max.	B min./max	Fe min./max	C min./max	P min./max	W min./max	Cu min./max	Mn min./max	Mo min./max	Nb min./max	Melting temperature (approximate)		
															Solidus °C	Liquidus °C	
<b>Ni-Cr-B alloys</b>																	
BNi-1	Ni 600	Rest	0,10	13,0/15,0	4,0/5,0	2,75/3,50	4,0/5,0	0,60/0,90	—/0,02	—/—	—/—	—/—	—/—	—/—	—/—	980	1060
BNi-1a	Ni 610	Rest	0,10	13,0/15,0	4,0/5,0	2,75/3,50	4,0/5,0	—/0,06	—/0,02	—/—	—/—	—/—	—/—	—/—	—/—	980	1070
BNi-9	Ni 612	Rest	0,10	13,5/16,5	—/—	3,25/4,0	—/1,5	—/0,06	—/0,02	—/—	—/—	—/—	—/—	—/—	—/—	1055	1055
BNi-2	Ni 620	Rest	0,10	6,0/8,0	4,0/5,0	2,75/3,50	2,5/3,5	—/0,06	—/0,02	—/—	—/—	—/—	—/—	—/—	—/—	970	1000
<b>Ni-Si-B alloys</b>																	
BNi-3	Ni 630	Rest	0,10	—/—	4,0/5,0	2,75/3,50	—/0,5	—/0,06	—/0,02	—/—	—/—	—/—	—/—	—/—	—/—	980	1040
BNi-4	Ni 631	Rest	0,10	—/—	3,0/4,0	1,50/2,20	—/1,5	—/0,06	—/0,02	—/—	—/—	—/—	—/—	—/—	—/—	980	1070
<b>Ni-Cr-Si alloys</b>																	
BNi-5	Ni 650	Rest	0,10	18,5/19,5	9,75/10,50	—/0,03	—/—	—/0,06	—/0,02	—/—	—/—	—/—	—/—	—/—	—/—	1080	1135
	Ni 655	Rest	0,10	21,0/23,0	6,0/7,0	—/0,01	—/—	—/0,16	3,5/4,5	—/—	—/—	—/—	—/—	—/—	—/—	960	1079
BNi-5a	Ni 660	Rest	0,10	18,5/19,5	7,0/7,5	1,0/1,5	—/0,5	—/0,10	—/0,02	—/—	—/—	—/—	—/—	—/—	—/—	1065	1150
BNi-5b	Ni 661	Rest	0,10	4,5/15,5	7,0/7,5	1,1/1,6	—/1,0	—/0,06	—/0,02	—/—	—/—	—/—	—/—	—/—	—/—	1030	1125
<b>Ni-W-Cr alloys</b>																	
BNi-10	Ni 670	Rest	0,10	10,0/13,0	3,0/4,0	2,0/3,0	2,5/4,5	0,40/0,55	—/0,02	15,0/17,0	—/—	—/—	—/—	—/—	—/—	970	1105
BNi-11	Ni 671	Rest	0,10	9,0/11,75	3,35/4,25	2,2/3,1	2,5/4,0	0,30/0,50	—/0,02	11,5/12,75	—/—	—/—	—/—	—/—	—/—	970	1095
<b>Ni-P alloys</b>																	
BNi-6	Ni 700	Rest	0,10	—/—	—/—	—/—	—/—	—/0,06	10,0/12,0	—/—	—/—	—/—	—/—	—/—	—/—	875	875
BNi-7	Ni 710	Rest	0,10	13,0/15,0	—/0,10	—/0,2	—/0,2	—/0,06	9,7/10,5	—/—	—/—	—/0,04	—/—	—/—	—/—	890	890
BNi-12	Ni 720	Rest	0,10	24,0/26,0	—/0,10	—/0,2	—/0,2	—/0,06	9,0/11,0	—/—	—/—	—/—	—/—	—/—	—/—	880	950
<b>Ni-Mn-Si-Cu alloys</b>																	
BNi-8	Ni 800	Rest	0,10	—/—	6,0/8,0	—/—	—/—	—/0,06	—/0,02	—/—	4,0/5,0	21,5/24,5	—/—	—/—	—/—	980	1010
<b>Ni-Cr-B-Si-Cu-Mo-Nb alloys</b>																	
BNi-13	Ni 810	Rest	0,10	7,0/9,0	3,8/4,8	2,75/3,50	—/0,4	—/0,06	—/0,02	—/—	2,0/3,0	—/—	1,5/2,5	1,5/2,5	—/—	970	1080
<b>Co-Ni-Si-W alloys</b>																	
BCo-1	Co 900	16,0/18,0	Rest	18,0/20,0	7,5/8,5	0,70/0,90	—/1,0	0,35/0,45	—/0,02	3,5/4,5	—/—	—/—	—/—	—/—	—/—	1120	1150

Maximum impurity limits applicable to all types are (% by mass) Al 0,05, Cd 0,010, Pb 0,025, S 0,02, Se 0,005, Ti 0,05, Zr 0,05; if elements other than those given in this table or this note are found to be present, the amount of these elements shall be determined; the total of such other elements shall not exceed 0,50 %.

**BCo classification (cobalt).**

Brazing alloys of the BCo-1 classification are generally used because of their high-temperature properties and their compatibility with cobalt-alloyed base metals.



## GUIDE TO AWS A5.9: BARE STAINLESS STEEL WELDING ELECTRODES AND RODS.

ER 209

Alloy designation a) for classification acc.		Chemical composition, % (m/m) b) c)											
ISO 14343-A	AWS A5.9	C	Si	Mn	P	S	Cr	Ni	Mo	N	Cu	Nb e	Other
<b>Martensitic/ferritic types</b>													
Martensitic stainless steel is a specific type of stainless steel alloy that can be hardened and tempered through multiple ways of aging/heat treatment 11,5-18% Cr / C 1,2 % including Ni													
	409	0,08	0,8	0,8	0,03	0,03	10,5 -13,5	0,6	0,5	—	0,75	—	Ti:10xC -1,5
	409Nb	0,12	0,5	0,6	0,03	0,03	10,5 -13,5	0,6	0,75	—	0,75	8 x C -1,0	—
13	(410)	0,15	1,0	1,0	0,03	0,02	12,0 -15	0,3	0,3	—	0,3	—	—
(13)	410	0,12	0,5	0,6	0,03	0,03	11,5 -13,5	0,6	0,75	—	0,75	—	—
13L		0,05	1,0	1,0	0,03	0,02	12,0 -15	0,3	0,3	—	0,3	—	—
13 4	(410NiMo)	0,05	1,0	1,0	0,03	0,02	11,0 -14	3,0 -5,0	0,4 -1,0	—	0,3	—	—
(13 4)	410NiMo	0,06	0,5	0,6	0,03	0,03	11,0 -12,5	4,0 -5,0	0,4 -0,7	—	0,75	—	—
	420	0,25 -0,40	0,5	0,6	0,03	0,03	12,0 -14,0	0,75	0,75	—	0,75	—	—
17	(430)	0,12	1,0	1,0	0,03	0,02	16,0 -19,0	0,3	0,3	—	0,3	—	—
(17)	430	0,10	0,5	0,6	0,03	0,03	15,5 -17,0	0,6	0,75	—	0,3	—	—
	430Nb	0,10	0,5	0,6	0,03	0,03	15,5 -17,0	0,6	0,75	—	0,3	8 x C -1,2	—
18LNb	430LNb	0,02	0,5	0,8	0,03	0,02	17,8 -18,8	0,3	0,3	0,02	0,3	0,05+7(C+N) up -0,5	—
	439	0,04	0,8	0,8	0,03	0,03	17,0 -19,0	0,6	0,5	--	0,75	--	Ti:10xC -1,1
	446LMo	0,015	0,4	0,4	0,02	0,02	25,0 -27,5	G	0,75 -1,50	0,015	G	--	--
<b>Austenitic types</b>													
The austenitic stainless steels contain 16-26% Cr, 8-24% / Ni + Mn, up to 0.40% / 0,10% C max. And small amounts of a few other elements such as Mo, Ti, Nb (Cb) and Ta. The balance between the Cr and Ni + Mn is normally adjusted to provide a microstructure of 90-100% austenite.													
	209	0,05	0,90	4,0 -7,0	0,03	0,03	20,5 -24,0	9,5 -12,0	1,5 -3,0	0,10 -0,30	0,75	—	V:0,10-0,30
	218	0,10	3,5 -4,5	7,0 -9,0	0,03	0,03	16,0 -18,0	8,0 -9,0	0,75	0,08 -0,18	0,75	—	—
	219	0,05	1,00	8,0 -10,0	0,03	0,03	19,0 -21,5	5,5 -7,0	0,75	0,10 -0,30	0,75	—	—
	240	0,05	1,00	10,5 -13,5	0,03	0,03	17,0 -19,0	4,0 -6,0	0,75	0,10 -0,30	0,75	—	—
	308	0,08	0,65	1,0 -2,5	0,03	0,03	19,5 -22,0	9,0 -11,0	0,75	—	0,75	—	—
	308Si	0,08	0,65 -1,00	1,0 -2,5	0,03	0,03	19,5 -22,0	9,0 -11,0	0,75	—	0,75	—	—
19 9L	(308L)	0,03	0,65	1,0 -2,5	0,03	0,02	19,5 -22,0	9,0 -11,0	0,75	—	0,75	—	—
(19 9L)	308L	0,03	0,65	1,0 -2,5	0,03	0,03	19,5 -22,0	9,0 -11,0	0,75	—	0,75	—	—
19 9LSi	(308LSi)	0,03	0,65 -1,2	1,0 -2,5	0,03	0,02	19,0 -21,0	9,0 -11,0	0,3	—	0,3	—	—
(19 9LSi)	308LSi	0,03	0,65 -1,0	1,0 -2,5	0,03	0,03	19,5 -22,0	9,0 -11,0	0,75	—	0,75	—	—

## GUIDE TO AWS A5.9: BARE STAINLESS STEEL WELDING ELECTRODES AND RODS.

ER 209

Alloy designation a) for classification acc.		Chemical composition, % (m/m) b) c)											
ISO 14343-A	AWS A5.9	C	Si	Mn	P	S	Cr	Ni	Mo	N	Cu	Nb e	Other
<b>Austenitic types continued</b>													
The austenitic stainless steels contain 16-26% Cr, 8-24% / Ni + Mn, up to 0.40% / 0,10% C max. And small amounts of a few other elements such as Mo, Ti, Nb (Cb) and Ta. The balance between the Cr and Ni + Mn is normally adjusted to provide a microstructure of 90-100% austenite.													
19 9Nb	(347)	0,08	0,65	1,0 - 2,5	0,03	0,02	19,0 - 21,0	9,0 - 11,0	0,3	—	0,3	10 x C <1,0	—
(19 9Nb)	347	0,08	0,65	1,0 - 2,5	0,03	0,03	19,0 - 21,5	9,0 - 11,0	0,75	—	0,75	10 x C <1,0	—
19 9NbSi	(347Si)	0,08	0,65 - 1,2	1,0 - 2,5	0,03	0,02	19,0 - 21,0	9,0 - 11,0	0,3	—	0,3	10 x C <1,0	—
(19 9NbSi)	347Si	0,08	0,65 - 1,0	1,0 - 2,5	0,03	0,03	19,0 - 21,5	9,0 - 11,0	0,75	—	0,75	10 x C <1,0	—
	347L	0,03	0,65	1,0 - 2,5	0,03	0,03	19,0 - 21,5	9,0 - 11,0	0,75	—	0,75	10 x C <1,0	—
	316	0,08	0,65	1,0 - 2,5	0,03	0,03	18,0 - 20,0	11,0 - 14,0	2,0 - 3,0	—	0,75	10 x C <1,0	—
	316Si	0,08	0,65 - 1,0	1,0 - 2,5	0,03	0,03	18,0 - 20,0	11,0 - 14,0	2,0 - 3,0	—	0,75	—	—
19 12 3 L	(316L)	0,03	0,65	1,0 - 2,5	0,03	0,02	18,0 - 20,0	11,0 - 14,0	2,5 - 3,0	—	0,3	—	—
(19 12 3 L)	316L	0,03	0,65	1,0 - 2,5	0,03	0,03	18,0 - 20,0	11,0 - 14,0	2,0 - 3,0	—	0,75	—	—
19 12 3 LSi	(316LSi)	0,03	0,65 - 1,2	1,0 - 2,5	0,03	0,02	18,0 - 20,0	11,0 - 14,0	2,5 - 3,0	—	0,3	—	—
(19 12 3 LSi)	316LSi	0,03	0,65 - 1,0	1,0 - 2,5	0,03	0,03	18,0 - 20,0	11,0 - 14,0	2,0 - 3,0	—	0,75	—	—
	316LCu	0,03	0,65	1,0 - 2,5	0,03	0,03	18,0 - 20,0	11,0 - 14,0	2,0 - 3,0	—	1,0 - 2,5	—	—
19 12 3 Nb	(318)	0,08	0,65	1,0 - 2,5	0,03	0,02	18,0 - 20,0	11,0 - 14,0	2,5 - 3,0	—	0,3	10 x C - 1,0	—
(19 12 3 Nb)	318	0,08	0,65	1,0 - 2,5	0,03	0,03	18,0 - 20,0	11,0 - 14,0	2,0 - 3,0	—	0,75	10 x C - 1,0	—
	318L	0,03	0,65	1,0 - 2,5	0,03	0,03	18,0 - 20,0	11,0 - 14,0	2,0 - 3,0	—	0,75	10 x C - 1,0	—
19 12 3 NbSi		0,08	0,65 - 1,2	1,0 - 2,5	0,03	0,02	18,0 - 20,0	11,0 - 14,0	2,5 - 3,0	—	0,3	10 x C - 1,0	—
	317	0,08	0,65	1,0 - 2,5	0,03	0,03	18,5 - 20,5	13,0 - 15,0	3,0 - 4,0	—	0,75	—	—
(18 15 3 L)	317L	0,03	0,65	1,0 - 2,5	0,03	0,03	18,5 - 20,5	13,0 - 15,0	3,0 - 4,0	—	0,75	—	—
	321	0,08	0,65	1,0 - 2,5	0,03	0,03	18,5 - 20,5	9,0 - 10,5	0,75	—	0,75	—	Ti: 9xC - 1,0

## GUIDE TO AWS A5.9: BARE STAINLESS STEEL WELDING ELECTRODES AND RODS.

ER 209

Alloy designation a) for classification acc. to		Chemical composition, % (m/m) b) c)											
ISO 14343-A	AWS A5.9	C	Si	Mn	P	S	Cr	Ni	Mo	N	Cu	Nb e	Other
<b>Ferritic-austenitic types, sometimes referred to as austenitic-ferritic types</b>													
Austenitic-ferritic stainless steels, more commonly known as duplex stainless steels, or DSS for short, consist of two basic phases. One is austenite, A, and the other is ferrite, F, present in about equal amounts (but not less than 30% each). The two phases owe their corrosion resistance to the high chromium content. Consist of chromium (18-26%) nickel (4-7%), molybdenum (0-4%), copper and iron													
22 9 3 NL	(2209)	0,03	1,0	2,5	0,03	0,02	21,0 -24,0	7,0 -10,0	2,5 -4,0	0,10 -0,20	0,3	—	—
(22 9 3 NL)	2209	0,03	0,90	2,5 -2,0	0,03	0,02	21,5 -23,5	7,5 -9,5	2,5 -3,5	0,08 -0,20	0,75	—	—
25 7 2 L		0,03	1,0	2,5	0,03	0,02	24,0 -27,0	6,0 -8,0	1,5 -2,5	—	0,3	—	—
25 9 3CuNL		0,03	1,0	2,5	0,03	0,02	24,0 -27,0	8,0 -11,0	2,5 -4,0	0,10 -0,20	1,5 -2,5	—	—
25 9 4NL		0,03	1,0	2,5	0,03	0,02	24,0 -27,0	8,0 -10,5	2,5 -4,5	0,20 -0,30	1,5	—	W 1,0
<b>Fully austenitic types</b>													
Consist of chromium (16-26%), nickel (6-12%) and iron													
18 15 3L f	(317) f	0,03	1,0	1,0 -4,0	0,03	0,02	17,0 -20,0	13,0 -16,0	2,5 -4,0	—	0,3	—	—
18 16 5NL f	(317) f	0,03	1,0	1,0 -4,0	0,03	0,02	17,0 -20,0	16,0 -19,0	3,5 -5,0	0,10 -0,20	0,3	—	—
19 13 4L f	(317L) f	0,03	1,0	1,0 -5,0	0,03	0,02	17,0 -20,0	12,0 -15,0	3,0 -4,5	—	0,3	—	—
19 13 4NL f		0,03	1,0	1,0 -5,0	0,03	0,02	17,0 -20,0	12,0 -15,0	3,0 -4,5	0,10 -0,20	0,3	—	—
20 25 5CuL f	(385) f	0,03	1,0	1,0 -4,0	0,03	0,02	19,0 -22,0	24,0 -27,0	4,0 -6,0	—	1,0 -2,0	—	—
(20 25 5CuL) f	385 f	0,025	0,50	1,0 -2,5	0,02	0,03	19,5 -21,5	24,0 -26,0	4,2 -5,2	—	1,2 -2,0	—	—
20 25 5CuNL f		0,03	1,0	1,0 -4,0	0,03	0,02	19,0 -22,0	24,0 -27,0	4,0 -6,0	0,10 -0,20	1,0 -2,0	—	—
20 16 3 MnL f		0,03	1,0	5,0 -9,0	0,03	0,02	19,0 -22,0	15,0 -18,0	2,5 -4,5	—	0,3	—	—
20 16 3 MnNL f		0,03	1,0	5,0 -9,0	0,03	0,02	19,0 -22,0	15,0 -18,0	2,5 -4,5	0,10 -0,20	0,3	—	—
25 22 2 N L f		0,03	1,0	3,5 -6,5	0,03	0,02	24,0 -27,0	21,0 -24,0	1,5 -3,0	0,10 -0,20	0,3	—	—
27 31 4 Cu L f	(383) f	0,03	1,0	1,0 -3,0	0,03	0,02	26,0 -29,0	30,0 -33,0	3,0 -4,5	—	0,7 -1,5	—	—
(27 31 4 Cu L) f	383 f	0,025	0,50	1,0 -2,5	0,02	0,03	26,5 -28,5	30,0 -33,0	3,2 -4,2	—	0,7 -1,5	—	—
	320 f	0,07	0,60	2,5	0,03	0,03	19,0 -21,0	32,0 -36,0	2,0 -3,0	—	3,0 -4,0	8 x C -1,0	—
	320LR f	0,025	0,15	1,5 -2,0	0,015	0,02	19,0 -21,0	32,0 -36,0	2,0 -3,0	—	3,0 -4,0	8 x C -0,40	—

## GUIDE TO AWS A5.9: BARE STAINLESS STEEL WELDING ELECTRODES AND RODS.

ER 209

Alloy designation a) for classification acc. to		Chemical composition, % (m/m) b) c)											
ISO 14343-A	AWS A5.9	C	Si	Mn	P	S	Cr	Ni	Mo	N	Cu	Nb e	Other
<b>Special types – Often used to dissimilar metal joining</b>													
	307 f	0,04 -0,14	0,65	3,3 -4,8	0,03	0,03	19,5 -22,0	8,0 -10,7	0,5 -1,5	—	0,75	—	—
18 8 Mn f		0,20	1,2	5,0 -8,0	0,03	0,03	17,0 -20,0	7,0 -10,0	0,3	—	0,3	—	—
20 10 3	(308Mo)	0,12	1,0	1,0 -2,5	0,03	0,02	18,0 -21,0	8,0 -12,0	1,5 -3,5	—	0,3	—	—
(20 10 3)	308Mo	0,08	0,65	1,0 -2,5	0,03	0,02	18,0 -21,0	9,0 -12,0	2,0 -3,0	—	0,75	—	—
	308LMo	0,03	0,65	1,0 -2,5	0,03	0,03	18,0 -21,0	9,0 -12,0	2,0 -3,0	—	0,75	—	—
23 12 L	(309L)	0,03	0,65	1,0 -2,5	0,03	0,02	22,0 -25,0	11,0 -14,0	0,3	—	0,3	—	—
(23 12 L)	309L	0,03	0,65	1,0 -2,5	0,03	0,02	23,0 -25,0	12,0 -14,0	0,75	—	0,75	—	—
23 12 LSi	(309LSi)	0,03	0,65 -1,2	1,0 -2,5	0,03	0,02	22,0 -25,0	11,0 -14,0	0,3	—	0,3	—	—
(23 12 LSi)	309LSi	0,03	0,65 -1,0	1,0 -2,5	0,03	0,02	23,0 -25,0	12,0 -14,0	0,75	—	0,75	—	—
23 12 Nb		0,08	1,0	1,0 -2,5	0,03	0,02	22,0 -25,0	11,0 -14,0	0,3	—	0,3	10 x C -1,0	—
	309LNb	0,03	0,65	1,0 -2,5	0,03	0,03	23,0 -25,0	12,0 -14,0	0,75	—	0,75	10 x C -1,0	—
	309Mo	0,12	0,65	1,0 -2,5	0,03	0,03	23,0 -25,0	12,0 -14,0	2,0 -3,0	—	0,75	—	—
23 12 2 L	(309LMo)	0,03	1,0	1,0 -2,5	0,03	0,02	21,0 -25,0	11,0 -15,5	2,0 -3,5	—	0,3	—	—
(23 12 2 L)	309LMo	0,03	0,65	1,0 -2,5	0,03	0,03	23,0 -25,0	12,0 -14,0	2,0 -3,0	—	0,75	—	—
29 9	(312)	0,15	1,0	1,0 -2,5	0,03	0,02	28,0 -32,0	8,0 -12,0	0,3	—	0,3	—	—
(29 9)	312	0,15	0,65	1,0 -2,5	0,03	0,03	28,0 -32,0	8,0 -10,5	0,75	—	0,75	—	—
<b>Heat resisting types</b>													
16 8 2	(16-8-2)	0,10	1,0	1,0 -2,5	0,03	0,02	14,5 -16,5	7,5 -9,5	1,0 -2,5	—	0,3	—	—
(16 8 2)	16-8-2	0,10	0,65	1,0 -2,5	0,03	0,03	14,5 -16,5	7,5 -9,5	1,0 -2,0	—	0,75	—	—
19 9 H	(19-10H)	0,04 -0,08	1,0	1,0 -2,5	0,03	0,02	18,0 -21,0	9,0 -11,0	0,3	—	0,3	—	—

## GUIDE TO AWS A5.9: BARE STAINLESS STEEL WELDING ELECTRODES AND RODS.

ER 209

Alloy designation a) for classification acc. to		Chemical composition, % (m/m) b) c)											
ISO 14343-A	AWS A5.9	C	Si	Mn	P	S	Cr	Ni	Mo	N	Cu	Nb e	Other
<b>Heat resisting types continued</b>													
(19 9 H)	19-10H	0,04 -0,08	0,65	1,0 -2,0	0,03	0,03	18,5 -20,0	9,0 -11,0	0,25	—	0,75	0,05	Ti 0,05
(19 9 H)	308H	0,04 -0,08	0,65	1,0 -2,5	0,03	0,03	19,5 -22,0	9,0 -11,0	0,50	—	0,75	—	—
19 12 3 H	(316H)	0,04 -0,08	1,0	1,0 -2,5	0,03	0,02	18,0 -20,0	11,0 -14,0	2,0 -3,0	—	0,3	—	—
(19 12 3 H)	316H	0,04 -0,08	0,65	1,0 -2,5	0,03	0,03	18,0 -20,0	11,0 -14,0	2,0 -3,0	—	0,75	—	—
22 12 H	(309)	0,04 -0,15	2,0	1,0 -2,5	0,03	0,02	21,0 -24,0	11,0 -14,0	0,3	—	0,3	—	—
(22 12 H)	309	0,12	0,65	1,0 -2,5	0,03	0,03	23,0 -25,0	12,0 -14,0	0,75	—	0,75	—	—
	309Si	0,12	0,65 -1,0	1,0 -2,5	0,03	0,03	23,0 -25,0	12,0 -14,0	0,75	—	0,75	—	—
25 4		0,15	2,0	1,0 -2,5	0,03	0,02	24,0 -27,0	4,0 -6,0	0,3	—	0,3	—	—
25 20 f	(310) f	0,08 -0,15	2,0	1,0 -2,5	0,03	0,02	24,0 -27,0	18,0 -22,0	0,3	—	0,3	—	—
(25 20) f	310 f	0,08 -0,15	0,65	1,0 -2,5	0,03	0,03	25,0 -28,0	20,0 -22,5	0,75	—	0,75	—	—
	310S f	0,08	0,65	1,0 -2,5	0,03	0,03	25,0 -28,0	20,0 -22,5	0,75	—	0,75	—	—
	310L f	0,03	0,65	1,0 -2,5	0,03	0,03	25,0 -28,0	20,0 -22,5	0,75	—	0,75	—	—
25 20 H f		0,35 -0,45	2,0	1,0 -2,5	0,03	0,02	24,0 -27,0	18,0 -22,0	0,3	—	0,3	—	—
25 20 Mn f		0,08 -0,15	2,0	2,5 -5,0	0,03	0,02	24,0 -27,0	18,0 -22,0	0,3	—	0,3	—	—
18 36 H f	(330)	0,18 -0,25	0,4 -2,0	1,0 -2,5	0,03	0,02	15,0 -19,0	33,0 -37,0	0,3	—	0,3	—	—
(18 36 H) f	330	0,18 -0,25	0,65	1,0 -2,5	0,03	0,03	15,0 -17,0	34,0 -37,0	0,75	—	0,75	—	—
<b>Precipitation hardening type</b>													
	630	0,05	0,75	0,25 -0,75	0,03	0,03	16,0 -16,75	4,5 -5,0	0,75	-	3,25 -4,0	0,15 -0,30	-

a) A designation in parentheses e.g. (308L) or (19/9L) indicates a near match in the other designation system, but not an exact match. The correct designation for a given composition range is the one not in parentheses. A given product may, by having a more restricted chemical composition which fulfils both sets of designation requirements, be assigned both designations independently.

b) Single values shown in the table are maximum values.

c) The results shall be rounded to the same number of significant figures as in the specified value using the rule A in accordance with Annex B of ISO 31-0:1992.

e) Up to 20% of the amount of Nb can be replaced by Ta.

f) The all-weld metal is in most cases fully austenitic and therefore can be susceptible to microfissuring or hot cracking. The occurrence of fissuring/cracking is reduced by increasing the weld metal Mn-level and in recognition of this the Mn-range is extended for a number of grades.

## GUIDE TO AWS A5.10: BARE ALUMINUM AND ALUMINUM-ALLOY WELDING ELECTRODES AND RODS

R = welding rods  
E = electrodes  
ER = Since some of these filler metals are used as electrodes in gas metal arc welding, and as welding rods in oxyfuel gas, gas tungsten arc, and plasma arc welding, both letters

ER 1100

Alloy Code	Si	Fe	Cu	Mn	Mg	Cr	Zn	Ga,V	Ti	Zr	Al	Be	other			
AWS Numerical	ISO Numerical	Chemical	min./max	min./max	min./max	min./max	min./max	min./max	min./max	min./max	min./max	min./max	each	total		
<b>ALUMINIUM-LOW ALLOYED</b>																
	Al 1070	Al99,7	0,20	0,25	0,04	0,03	0,03	-	0,04	V 0,05	0,03	-	99,7	0,0003	0,03	-
	Al 1080A	Al99,8(A)	0,15	0,15	0,03	0,02	0,02	-	0,06	Ga 0,03	0,02	-	99,8	0,0003	0,02	-
1188	Al 1188	Al 99,88	0,06	0,06	0,005	0,01	0,01	-	0,03	Ga 0,03 V 0,05	0,01	-	99,88	0,0003	0,01	-
1100	Al 1100	Al99,0Cu	Si+Fe 0,95	Si+Fe 0,95	0,05-0,20	0,05	-	-	0,10	-	-	-	99,00	0,0003	0,05	0,15
	Al 1200	Al99,0	Si+Fe 1,00	Si+Fe 1,00	0,05	0,05	-	-	0,10	-	0,05	-	99,00	0,0003	0,05	0,15
	Al 1450	Al99,5Ti	0,25	0,40	0,05	0,05	0,05	-	0,07	-	0,10-0,20	-	99,50	0,0003	0,03	-
<b>ALUMINIUM-COPPER</b>																
2319	Al 2319	AlCu6MnZrTi	0,20	0,30	5,8-6,8	0,20-0,40	0,02	-	0,10	V 0,05-0,15	-	0,10-0,25	Rem	0,0003	0,05	0,15
<b>ALUMINIUM-MANGANESE</b>																
	Al 3103	AlMn 1	0,50	0,7	0,10	0,9-1,5	0,30	0,10	0,20	-	Ti + Zr 0,10	Ti + Zr 0,10	Rem	0,0003	0,05	0,15
<b>ALUMINIUM-SILICIUM</b>																
4009	Al 4009	AlSi5Cu1Mg	4,5-5,5	0,20	1,0-1,5	0,10	0,45-0,60	-	0,10	-	0,20	-	Rem	0,0003	0,05	0,15
4010	Al 4010	AlSi7Mg	6,5-7,5	0,20	0,20	0,10	0,30-0,45	-	0,10	-	0,20	-	Rem	0,0003	0,05	0,15
4011	Al 4011	AlSi7Mg0,5Ti	6,5-7,5	0,20	0,20	0,10	0,45-0,7	-	0,10	-	0,04-0,20	-	Rem	0,04-0,07	0,05	0,15
	Al 4018	AlSi7Mg	6,5-7,5	0,20	0,05	0,10	0,50-0,8	-	0,10	-	0,20	-	Rem	0,0003	0,05	0,15
	Al 4043	AlSi5	4,5-6,0	0,8	0,30	0,05	0,05	-	0,10	-	0,20	-	Rem	0,0003	0,05	0,15
4043	Al 4043A	AlSi5(A)	4,5-6,0	0,6	0,30	0,15	0,20	-	0,10	-	0,15	-	Rem	0,0003	0,05	0,15
	Al 4046	AlSi10Mg	9,0-11,0	0,50	0,03	0,40	0,20-0,50	-	0,10	-	0,15	-	Rem	0,0003	0,05	0,15
4047	Al 4047	AlSi12	11,0-13,0	0,8	0,30	0,15	0,10	-	0,20	-	-	-	Rem	0,0003	0,05	0,15
	Al 4047A	AlSi12(A)	11,0-13,0	0,6	0,30	0,15	0,10	-	0,20	-	0,15	-	Rem	0,0003	0,05	0,15
4145	Al 4145	AlSi10Cu4	9,3-10,7	0,8	3,3-4,7	0,15	0,15	0,15	0,20	-	-	-	Rem	0,0003	0,05	0,15
4663	Al 4643	AlSi4Mg	3,6-4,6	0,8	0,10	0,05	0,10-0,30	-	0,10	-	0,15	-	Rem	0,0003	0,05	0,15
<b>ALUMINIUM-MAGNESIUM</b>																
	Al 5249	AlMg2Mn0,8Zr	0,25	0,40	0,05	0,50-1,1	1,6-2,5	0,30	0,20	-	0,15	0,10-0,20	Rem	0,0003	0,05	0,15
5554	Al 5554	AlMg2,7Mn	0,25	0,40	0,10	0,50-1,0	2,4-3,0	0,05 - 0,20	0,25	-	0,05-0,20	-	Rem	0,0003	0,05	0,15
5654	Al 5654	AlMg3,5Ti	Si + Fe 0,45	Si + Fe 0,45	0,05	0,01	3,1-3,9	0,15-0,35	0,20	-	0,04-0,15	-	Rem	0,0003	0,05	0,15
	Al 5654A	AlMg3,5T	Si + Fe 0,45	Si + Fe 0,45	0,05	0,01	3,1-3,9	0,15-0,35	0,20	-	0,04-0,15	-	Rem	0,0005	0,05	0,15
	Al 5754c	AlMg3	0,40	0,40	0,10	0,50	2,6-3,6	0,30	0,20	-	0,15	-	Rem	0,0003	0,05	0,15
5356	Al 5356	AlMg5Cr(A)	0,25	0,40	0,10	0,05-0,20	4,7 - 5,5	0,05 - 0,20	0,10	-	0,06 - 0,20	-	Rem	0,0003	0,05	0,15
	Al 5356A	AlMg5Cr(A)	0,25	0,40	0,10	0,05-0,20	4,5 - 5,5	0,05 - 0,20	0,10	-	0,06 - 0,20	-	Rem	0,0005	0,05	0,15
5556	Al 5556	AlMg5Mn1Ti	0,25	0,40	0,10	0,50-1,0	4,7 - 5,5	0,05 - 0,20	0,25	-	0,05 - 0,20	-	Rem	0,0003	0,05	0,15
	Al 5556C	AlMg5Mn1Ti	0,25	0,40	0,10	0,50-1,0	4,7 - 5,5	0,05 - 0,20	0,25	-	0,05 - 0,20	-	Rem	0,0005	0,05	0,15
	Al 5556A	AlMg5Mn	0,25	0,40	0,10	0,6-1,0	5,0 - 5,5	0,05 - 0,20	0,20	-	0,05 - 0,20	-	Rem	0,0003	0,05	0,15
	Al 5556B	AlMg5Mn	0,25	0,40	0,10	0,6-1,0	5,0 - 5,5	0,05 - 0,20	0,20	-	0,05 - 0,20	-	Rem	0,0005	0,05	0,15
5183	Al 5183	AlMg4,5Mn0,7(A)	0,40	0,40	0,10	0,50-1,0	4,3 - 5,2	0,05 - 0,25	0,25	-	0,15	-	Rem	0,0003	0,05	0,15
	Al 5183A	AlMg4,5Mn0,7(A)	0,40	0,40	0,10	0,50-1,0	4,3 - 5,2	0,05 - 0,25	0,25	-	0,15	-	Rem	0,0005	0,05	0,15
	Al 5087	AlMg4,5MnZr	0,25	0,40	0,05	0,7-1,1	4,5 - 5,2	0,05 - 0,25	0,25	-	0,15	0,10-0,20	Rem	0,0003	0,05	0,15
	Al 5187	AlMg4,5MnZr	0,25	0,40	0,05	0,7-1,1	4,5 - 5,2	0,05 - 0,25	0,25	-	0,15	0,10-0,20	Rem	0,0005	0,05	0,15
206.0	SA0206		0,10	0,15	4,2 - 5,0	0,20-0,50	0,15-0,35	-	0,10	Ni 0,5	0,15-0,30	-	Rem	-	0,05	0,15
C355.0	SA3355		4,5 - 5,5	0,20	1,0 - 1,5	0,10	0,40-0,6	-	0,10	-	0,20	-	Rem	-	0,05	0,15
A356.0	SA1356		6,5 - 7,5	0,20	0,20	0,10	0,25-0,45	-	0,10	-	0,20	-	Rem	-	0,05	0,15
357.0	SA0357		6,5 - 7,5	0,15	0,05	0,03	0,45-0,60	-	0,05	-	0,20	-	Rem	-	0,05	0,15
A357.0	SA1357		6,5 - 7,5	0,20	0,20	0,10	0,40-0,7	-	0,10	-	0,04-0,20	-	Rem	-	0,05	0,15

- a) The filler metal shall be analyzed for the specific elements for which values are shown in this table. If the presence of other elements is indicated in the course of this work, the amount of those elements shall be determined to ensure that they do not exceed the limits specified for "Other Elements."
- b) Single values are maximum, except where otherwise specified.
- c) SAE/ASTM Unified Numbering System for Metals and Alloys.
- d) Silicon plus iron shall not exceed 0.95 percent.
- e) Beryllium shall not exceed 0.0008 percent.
- f) The aluminum content for unalloyed aluminum is the difference between 100.00 percent and the sum of all other metallic elements present in amounts of 0.010 percent or more each, expressed to the second decimal before determining the sum.
- g) Vanadium content shall be 0.05 percent maximum. Gallium content shall be 0.03 percent maximum.
- h) Vanadium content shall be 0.50-0.15 percent. Zirconium content shall be 0.10-0.25 percent.
- i) Silicon plus iron shall not exceed 0.45 percent.
- j) Tin content shall not exceed 0.05 percent. k. Beryllium content shall be 0.04-0.07 percent.
- k) The beryllium content should be 0.04-0.07 percent.

## GUIDE TO AWS A5.11: NICKEL AND NICKEL-ALLOY WELDING ELECTRODES FOR SHIELDED METAL ARC WELDING

E = Covered electrode for manual metal arc

E

Ni-1

Alloy Code			Chemical composition % (m/m)														
Numerical ISO	Numerical AWS	Chemical	C	Mn	Fe	Si	Cu	Ni	Co	Al	Ti	Cr	Nb	Mo	V	W	other
<b>NICKEL</b>																	
Ni 2061	ENi-1	NiTi3	0,10	0,70	0,70	1,20	0,20	≥ 92,0	-	1,0	1,0-40	-	-	-	-	-	-
<b>NICKEL-COPPER</b>																	
Ni 4060	ENiCu-7	NiCu30Mn3Ti	0,15	4,0	2,5	1,5	27,0 - 34,0	≥ 62,0	-	1,0	1,0	-	-	-	-	-	-
Ni 4061		NiCu27Mn3NbTi	0,15	4,0	2,5	1,3	24,0 - 31,0	≥ 62,0	-	1,0	1,5	-	3,0	-	-	-	-
<b>NICKEL-CHROMIUM</b>																	
Ni 6082		NiCr20Mn3Nb	0,10	2,0 - 6,0	4,0	0,8	0,5	≥ 63,0	-	-	0,5	18,0 - 22,0	1,5 - 3,0	2,0	--	-	-
Ni 6231	ENiCrW-Mo-1	NiCr22W14Mo	0,05-0,10	0,3 - 1,0	3,0	0,3 - 0,7	0,5	≥ 45,0	5,0	0,5	0,1	20,0 - 24,0	-	1,0 - 3,0	-	13,0 - 15,0	-
<b>NICKEL-CHROMIUM-IRON</b>																	
Ni 6025		NiCr25Fe10AlY	0,10 - 0,25	0,50	8,0 - 11,0	0,8	-	≥ 55,0	-	1,5 - 2,2	0,3	24,0 - 26,0	-	-	-	-	0,15Y
Ni 6062	ENiCrFe-1	NiCr15Fe8Nb	0,08	3,5	11,0	0,8	0,5	≥ 62,0	-	-	-	13,0 - 17,0	0,50 - 4,0	-	-	-	-
Ni 6133	ENiCrFe-2	NiCr16Fe12NbMo	0,10	1,0 - 3,5	12,0	0,8	0,5	≥ 62,0	-	-	-	13,0 - 17,0	0,50 - 3,0	0,50 - 2,5	-	-	-
Ni 6093	ENiCrFe-4	NiCr15Fe8NbMo	0,20	1,0 - 5,0	12,0	1,0	0,5	≥ 60,0	-	-	-	13,0 - 17,0	1,0 - 3,5	1,0 - 3,5	-	-	-
Ni 6094	ENiCrFe-9	NiCr14Fe4NbMo	0,15	1,0 - 4,5	12,0	0,8	0,5	≥ 55,0	-	-	-	12,0 - 17,0	0,5 - 3,0	2,5 - 5,5	-	1,5	-
Ni 6095	ENiCrFe-10	NiCr15Fe8NbMoW	0,20	1,0 - 3,5	12,0	0,8	0,5	≥ 55,0	-	-	-	13,0 - 17,0	1,0 - 3,5	1,0 - 3,5	-	1,5 - 3,5	-
Ni 6152	ENiCrFe-7	NiCr30Fe9Nb	0,05	5,0	7,0-12,0	0,8	0,5	≥ 50,0	-	0,5	0,5	28,0 - 31,5	1,0 - 2,5	0,5	-	-	-
Ni 6182	ENiCrFe-3	NiCr15Fe6Mn	0,10	5,0 - 10,0	10,0	1,0	0,5	≥ 60,0	-	-	1,0	13,0 - 17,0	1,0 - 3,5	-	-	-	*0,3 max. Ta ist wichtig
Ni 6333		NiCr25Fe16CoNbW	0,10	1,2 - 2,0	≥ 16,0	0,8 - 1,2	0,5	44,0 - 47,0	2,5 - 3,5	-	-	24,0 - 26,0	-	2,5 - 3,5	-	2,5 - 3,5	-
Ni 6701		NiCr36Fe7Nb	0,35 - 0,50	0,5 - 2,0	7,0	0,50 - 2,0	-	42,0 - 48,0	-	-	-	33,0 - 39,0	0,8 - 1,8	-	-	-	-
Ni 6702		NiCr28Fe6W	0,35 - 0,50	0,5 - 1,5	6,0	0,50 - 2,0	-	47,0 - 50,0	-	-	-	27,0 - 30,0	-	-	-	-	4,0 - 5,5
Ni 6704		NiCr25Fe10Al3YC	0,15 - 0,30	0,5	8,0 - 11,0	0,8	-	≥ 55,0	-	1,8 - 2,8	0,3	24,0 - 26,0	-	-	-	-	0,15Y
Ni 8025		NiCr29Fe30Mo	0,06	1,0 - 3,0	30,0	0,7	1,5 - 3,0	35,0 - 40,0	-	0,1	1,0	27,0 - 31,0	1,0	2,5 - 4,5	-	-	*or Nb
Ni 8165		NiCr25Fe30Mo	0,03	1,0 - 3,0	30,0	0,7	1,5 - 3,0	37,0 - 42,0	-	0,1	1,0	23,0 - 27,0	-	3,5 - 7,5	-	-	-
<b>NICKEL-MOLYBDENUM</b>																	
Ni 1001	ENiMo-1	NiMo28Fe5	0,07	1,0	4,0 - 7,0	1,0	0,5	≥ 55,0	2,5	-	-	1,0	-	26 - 30	0,6	1,0	-
Ni 1004	ENiMo-3	NiMo25Cr5Fe5	0,12	1,0	4,0 - 7,0	1,0	0,5	≥ 60,0	-	-	-	2,5 - 5,0	-	23 - 27	0,6	1,0	-
Ni 1008	ENiMo-8	NiMo19WCr	0,10	1,5	10,0	0,8	0,5	≥ 60,0	-	-	-	0,5 - 3,5	-	17 - 20	-	2,0 - 4,0	-
Ni 1009	ENiMo-9	NiMo20WCr	0,10	1,5	7,0	0,8	0,3 - 1,3	≥ 62,0	-	-	-	-	-	18 - 22	-	2,0 - 4,0	-
Ni 1062		NiMo24Cr8Fe6	0,02	1,0	4,0 - 7,0	0,7	-	≥ 60,0	-	-	-	6,0 - 9,0	-	22 - 26	-	-	-
Ni 1066	ENiMo-7	NiMo28	0,02	2,0	2,2	0,2	0,5	≥ 64,5	-	-	-	1,0	-	26 - 30	-	1,0	-
Ni 1067	ENiMo-10	NiMo30Cr	0,02	2,0	1,0 - 3,0	0,2	0,5	≥ 62,0	3,0	-	-	1,0 - 3,0	-	27 - 32	-	3,0	-
Ni 1069		NiMo28Fe4Cr	0,02	1,0	2,0 - 5,0	0,7	-	≥ 65,0	1,0	0,5	-	0,5 - 1,5	-	26 - 30	-	-	-



## GUIDE TO AWS A5.11: NICKEL AND NICKEL-ALLOY WELDING ELECTRODES FOR SHIELDED METAL ARC WELDING

E = Covered electrode for manual metal arc

E

NiCrFe-3

Alloy code			Chemical composition % (m/m)													others	
Numerical ISO	Numerical AWS	Chemical	C	Mn	Fe	Si	Cu	Ni	Co	Al	Ti	Cr	Nb	Mo	V	W	others
<b>Nickel-Chromium-Molybdenum</b>																	
Ni 6002	ENiCrMo-2	NiCr22Fe18Mo	0,05 - 0,15	1,0	17 - 20	1,0	0,5	≥ 45,0	0,5 - 2,5	-	-	20 - 23	-	8,0 - 10	-	0,2 - 1,0	-
Ni 6012		NiCr22Mo9	0,03	1,0	3,5	0,7	0,5	≥ 58,0	-	0,4	0,4	20 - 23	1,5	8,5 - 10,5	-	-	-
Ni 6022	ENiCrMo-10	NiCr21Mo13W3	0,02	1,0	2,0 - 6,0	0,2	0,5	≥ 49,0	2,5	-	-	20 - 22,5	-	12,5 - 14,5	0,4	2,5 - 3,5	-
Ni 6024		NiCr26Mo14	0,02	0,5	1,5	0,2	0,5	≥ 55,0	-	-	-	25 - 27	-	13,5 - 15,0	-	-	-
Ni 6030	ENiCrMo-11	NiCr29Mo5F105e15 W2	0,03	1,5	13 - 17	1,0	1,0 - 2,4	≥ 36,0	5,0	-	-	28 - 31,5	0,3 - 1,5	4,0 - 6,0	-	1,5 - 4,0	-
Ni 6059	ENiCrMo-13	NiCr23Mo16	0,02	1,0	1,5	0,2	-	≥ 56,0	-	-	-	22 - 24	-	15,0 - 16,5	-	-	-
Ni 6200	ENiCrMo-17	NiCr23Mo16Cu2	0,02	1,0	3,0	0,2	1,3 - 1,9	≥ 45,0	2,0	-	-	20 - 27	-	15,0 - 17,0	-	-	-
Ni 6205		NiCr25Mo16	0,02	0,5	5,0	0,2	2,0	≥ 50,0	-	0,4	-	22 - 27	-	13,5 - 16,5	-	-	-
Ni 6275	ENiCrMo-5	NiCr15Mo16Fe5W3	0,01	1,0	4,0 - 7,0	1,0	0,5	≥ 50,0	2,5	-	-	14,5 - 16,5	-	15,0 - 18,0	0,4	3,0 - 4,5	-
Ni 6276	ENiCrMo-4	Ni Cr15Mo15Fe6W4	0,02	1,0	4,0 - 7,0	0,2	0,5	≥ 50,0	2,5	-	-	14,5 - 16,5	-	15,0 - 17,0	0,4	3,0 - 4,5	-
Ni 6452		NiCr19Mo15	0,025	2,0	1,5	0,4	0,5	≥ 56,0	-	-	-	18,0 - 20,0	0,4	14,0 - 16,0	0,4	-	-
Ni 6455	ENiCrMo-7	NiCr16Mo15Ti	0,02	1,5	3,0	0,2	0,5	≥ 56,0	2,0	-	0,7	14,0 - 18,0	-	14,0 - 17,0	-	0,5	-
Ni 6620	ENiCrMo-6	NiCr14Mo7Fe	0,10	2,0 - 4,0	10,0	1,0	0,5	≥ 55,0	-	-	-	12,0 - 17,0	0,5 - 2,0	5,0 - 9,0	-	1,0 - 2,0	-
Ni 6625	ENiCrMo-3	NiCr22Mo9Nb	0,10	2,0	7,0	0,8	0,5	≥ 55,0	-	-	-	20,0 - 23,0	3,0 - 4,2	8,0 - 10,0	-	-	-
Ni 6627	ENiCrMo-12	NiCr21MoFeNb	0,03	2,2	5,0	0,7	0,5	≥ 57,0	-	-	-	20,5 - 22,5	1,0 - 2,8	8,8 - 10,0	-	0,5	-
Ni 6650		NiCr20Fe14Mo11WN	0,03	0,7	12 - 15	0,6	0,5	≥ 44,0	1,0	0,5	-	19,0 - 22,0	0,3	10,0 - 13,0	-	1,0 - 2,0	0,15 N 0,02 S
Ni 6686	ENiCrMo-14	NiCr21Mo16W4	0,02	1,0	5,0	0,3	0,5	≥ 49,0	-	-	0,3	19,0 - 23,0	-	15,0 - 17,0	-	3,0 - 4,4	-
Ni 6985	ENiCrMo-9	NiCr22Mo7Fe19	0,02	1,0	18 - 21	1,0	1,5 - 2,5	≥ 45,0	5,0	-	-	21,0 - 23,5	1,0	6,0 - 8,0	-	1,5	-
<b>Nickel-Chromium-Cobalt-Molybdenum</b>																	
Ni 6617	ENiCrCoMo-1	NiCr22Co12Mo	0,05 - 0,15	3,0	5,0	1,0	0,5	≥ 45,0	9,0 - 15	1,5	0,6	20 - 26	1,0	8,0 - 10,0	-	-	-

## GUIDE TO AWS A5.12: TUNGSTEN AND OXIDE DISPERSED TUNGSTEN ELECTRODES FOR ARC WELDING AND CUTTING

W = Tungsten electrodes

W

Ce-2

Symbol	Chemical composition of all-weld metal, % *				Color code, RGB colour value and colour sample a)	Description and Intended Use of Electrodes
	Oxide Addition		Impurities	Tungsten		
	Principal Oxide	Mass %	Mass %	Mass %		
WP	None	N.A.b	0.5 max.	99.5 max	Green #008000	<b>The standard electrode for aluminium welding</b> Composition: W pure A classic with medium welding properties. To improve durability, ignition and load capacity there are replacement options <b>Categories:</b> Radiation free, AC welding
WCe 20	CeO <sub>2</sub>	1.8 - 2.2	0.5 max.	Balance	Grey (formerly orange) #808080	<b>The classic for direct current welding</b> Composition: W + 2% cerium Next to WL15 and WT20 the most popular tungsten electrode. Their advantage is an excellent tool life. Minor reductions in the ignition capability have to be accepted <b>Categories:</b> Radiation free, Direct current welding
WLa 10	La <sub>2</sub> O <sub>3</sub>	0.8 - 1.2	0.5 max.	Balance	Black #000000	<b>The favourite for plasma welding and cutting</b> Composition: W + 1% lanthanum With 1% lanthanum, which has a decisive influence on the ignition capability. Main application area is plasma cutting and welding <b>Categories:</b> Radiation free, Direct current welding
WLa 15	La <sub>2</sub> O <sub>3</sub>	1.3 - 1.7	0.5 max.	Balance	Gold #FFD700	<b>A talent in all areas</b> Composition: W + 1.5% lanthanum A real alternative to the WT20! Due to the higher lanthanum content the ignition behaviour is further improved compared to the WL10 <b>Categories:</b> Radiation free, Universal, DC welding, AC welding, Stainless steel
WLa 20	La <sub>2</sub> O <sub>3</sub>	1.8 - 2.2	0.5 max.	Balance	Blue #0000FF	<b>Unsurpassed use in automated welding</b> Composition: W + 2% lanthanum The electrode with the currently highest lanthanum content ensures unsurpassed ignition results The main field of application is automated welding <b>Categories:</b> radiation free, automatic welding machine, direct current welding
WTh 10	ThO <sub>2</sub>	0.8 - 1.2	0.5 max.	Balance	Yellow #FFFF00	No longer plays a major role
WTh 20	ThO <sub>2</sub>	1.7 - 2.2	0.5 max.	Balance	Red #FF0000	<b>The igniter - 2% thorium</b> Composition: W + 2% thorium Due to its very good ignition properties, this is a widely used type of electrode, which however, due to its 2% share of radioactive thorium, is increasingly being discussed. This type can now be successfully replaced by radiation-free electrodes such as WL15 <b>Categories:</b> Thorium-containing, direct current welding
(WTh 30)	ThO <sub>2</sub>	2.8 - 3.2	0.5 max.	Balance	Violet #EE82EE	<b>3% Thorium - for better ignition behaviour</b> Composition: W + 3% thorium Less common electrode type with very good ignition properties devices like the WT20 are increasingly being discussed and can now be successfully replaced completely by radiation-free electrodes such as Lymox or WL15 <b>Categories:</b> Thorium-containing, direct current welding
WZr 3	ZrO <sub>2</sub>	0.15 - 0.50	0.5 max.	Balance	Brown #A52A2A	No longer plays a major role
WZr 8	ZrO <sub>2</sub>	0.7 - 0.9	0.5 max.	Balance	White #FFFFFF	<b>The specialist for aluminium</b> Composition: W + 0.8% zirconium Improved ignition, lifetime & current carrying capacity compared to the green electrode <b>Categories:</b> Radiation free, AC welding

**GENERAL NOTE:**

Intentional additions of "doping oxides" other than indicated for a particular electrode classification is prohibited.

**NOTES:**a) RGB color values and color samples can be found at the following website: <http://msdn2.microsoft.com/en-us/library/ms531197.aspx>

b) N.A. p Not applicable.

## GUIDE TO AWS A 5.13: GMAW ELECTRODES FOR SURFACING

E = Covered electrode for manual metal arc

E Fe1

Alloy type	UNS Number e)	IRON BASE SURFACING ELECTRODES - Chemical composition % (m/m)											
		C	Mn	Si	Cr	Ni	Mo	V	W	Ti	Nb	Fe	others
EFe1	W74001	0.04-0.020	0.5-2.0	1.0	0.5-3.5	-	1.5	-	-	-	-	Rem	1.0
EFe2	W74002	0.10-0.30	0.5-2.0	1.0	1.8-3.8	1.0	1.0	0,35	-	-	-	Rem	1.0
EFe3	W74003	0.50-0.80	0.5-1.5	1.0	4.0-8.0	-	1.0	-	-	-	-	Rem	1.0
EFe4	W74004	1.0-2.0	0.5-2.0	1.0	3.0-5.0	-	-	-	-	-	-	Rem	1.0
EFe5	W75110	0.30-0.80	0.5-2.5	0.90	1.5-3.0	-	-	-	-	-	-	Rem	1.0
EFe6	W77510	0.6-1.0	0.4-1.0	1.0	3.0-5.0	-	7.0-9.5	0.5-1.5	0.5-1.5	-	-	Rem	1.0
EFe7	W77610	1.5-3.0	0.5-2.0	1.5	4.0-8.0	-	1.0	-	-	-	-	Rem	1.0
EFeMn-A	W79110	0.5-1.0	12-16	1.3	-	2.5-5.0	-	-	-	-	-	Rem	1.0
EFeMn-B	W79310	0.5-1.0	12-16	1.3	-	-	0.5-1.5	-	-	-	-	Rem	1.0
EFeMn-C	W79210	0.5-1.0	12-16	1.3	2.5-5.0	2.5-5.0	-	-	-	-	-	Rem	1.0
EFeMn-D	W79410	0.5-1.0	15-20	1.3	4.5-7.5	-	-	0.4-1.2	-	-	-	Rem	1.0
EFeMn-E	W79510	0.5-1.0	15-20	1.3	3.0-6.0	1.0	-	-	-	-	-	Rem	1.0
EFeMn-F	W79610	0.8-1.2	17-21	1.3	3.0-6.0	1.0	-	-	-	-	-	Rem	1.0
EFeMnCr	W79710	0.25-0.75	12-18	1.3	13-17	0.5-2.0	2.0	1.0	-	-	-	Rem	1.0
EFeCr-A1A	W74011	3.5-4.5	4.0-6.0	0.5-2.0	20-25	-	0.5	-	-	-	-	Rem	1.0
EFeCr-A2	W74012	2.5-3.5	0.5-1.5	0.5-1.5	7.5-9.0	-	-	-	-	1,2-1,8	-	Rem	1.0
EFeCr-A3	W74013	2.5-4.5	0.5-2.0	1.0-2.5	14-20	-	1.5	-	-	-	-	Rem	1.0
EFeCr-A4	W74014	3.5-4.5	1.5-3.5	1.5	23-29	-	1.0-3.0	-	-	-	-	Rem	1.0
EFeCr-A5	W74015	1.5-2.5	0.5-1.5	2.0	24-32	4.0	4.0	-	-	-	-	Rem	1.0
EFeCr-A6	W74016	2.5-3.5	0.5-1.5	1.0-2.5	24-30	-	0.5-2.0	-	-	-	-	Rem	1.0
EFeCr-A7	W74017	3.5-5.0	0.5-1.5	0.5-2.5	23-30	-	2.0-4.5	-	-	-	-	Rem	1.0
EFeCr-A8	W74018	2.5-4.5	0.5-1.5	1.5	30-40	-	2.0	-	-	-	-	Rem	1.0
EFeCr-E1	W74211	5.0-6.5	2.0-3.0	0.8-1.5	12-16	-	-	-	-	4.0-7.0	-	Rem	1.0
EFeCr-E2	W74212	4.0-6.0	0.5-1.5	1.5	14-20	-	5.0-7.0	1.5	-	-	-	Rem	1.0
EFeCr-E3	W74213	5.0-7.0	0.5-2.0	0.5-2.0	18-28	-	5.0-7.0	-	3.0-5.0	-	-	Rem	1.0
EFeCr-E4	W74214	4.0-6.0	0.5-1.5	1.0	20-30	-	5.0-7.0	0.5-1.5	2.0	-	4.0-7.0	Rem	1.0

**Anmerkungen:** a) Solid bare electrodes and rods previously classified in AWS A5.13-80 are now either discontinued or reclassified in AWS A5.21:2001, Specification for Bare Electrodes and Rods for Surfacing (see A8 in Annex A). b) Single values are maximum. Rem = Remainder. c) Electrodes and rods shall be analyzed for the specific elements for which values are shown in this table. If the presence of other elements is indicated in the course of this work, the amount. d) Sulfur and phosphorus contents each shall not exceed 0.035%. e) ASTM/SAE Unified Numbering System for Metals and Alloys.

Alloy type	UNS Number d)	NICKEL AND COBALT BASE SURFACING ELECTRODES - Chemical composition % (m/m)											
		C	Mn	Si	Cr	Ni	Mo	Fe	W	Co	B	V	others
ECrCo-A	W73006	0.7- 1.4	2.0	2.0	25-32	3.0	1.0	5.0	3.0-6.0	Rem	--	-	1.0
ECrCo-B	W73012	1.0-1.7	2.0	2.0	25-32	3.0	1.0	5.0	7.0-9.5	Rem	-	-	1.0
ECrCo-C	W73001	1.7-3.0	2.0	2.0	25-33	3.0	1.0	5.0	11-14	Rem	-	-	1.0
ECrCo-E	W73021	0.15-0.40	1.5	2.0	24-29	2.0-4.0	4.5-6.5	5.0	0.50	Rem	-	-	1.0
ENiCr-C	W89606	0.5-1.0	-	3.5-5.5	12-18	Rem	-	3.5-5.5	-	1.0	2.5-4.5	-	1.0
ENiCrMo-5A	W80002	0.12	1.0	1.0	14-18	Rem	14-18	4.0-7.0	3.0-5.0	-	-	0.40	1.0
ENiCrFeCo	W83002	2.2-3.0	1.0	0.6-1.5	25-30	10-33	7.0-10.0	20-25	2.0-4.0	10-15	-	-	1.0

**NOTES:** a) Single values are maximum percentages. Rem = Remainder. b) The weld metal shall be analyzed for the specific elements for which values are shown in this table. If the presence of other elements is indicated in the course of this work, the amount of those elements shall be determined to ensure that their total does not exceed the limit specified for "Other Elements, Total" in the last column of the table. c) Sulfur and phosphorus contents each shall not exceed 0.03%. d) ASTM/SAE Unified Numbering System for Metals and Alloys. e) Includes incidental cobalt.

Alloy type	UNS Number c)	COPPER BASE SURFACING ELECTRODES - Chemical composition % (m/m)											
		Cu	Mn	P	Si	Fe	Al	Zn	Ni	Pb	Sn	Ti	others
ECuAl-A2f	W60617	Rem	g	-	1.5	0.5-5.0	8.5-11.0	g	g	0.02	g	-	0.50
ECuAl-Bf	W60619	Rem	g	-	1.5	2.5-5.0	11-12	g	g	0.02	g	-	0.50
ECuAl-C	W60625	Rem	-	-	1.0	3.0-5.0	12-13	0.02	-	0.02	-	-	0.50
ECuAl-D	W61625	Rem	-	-	1.0	3.0-5.0	13-14	0.02	-	0.02	-	-	0.50
ECuAl-E	W62625	Rem	-	-	1.0	3.0-5.0	14-15	0.02	-	0.02	-	-	0.50
ECuSif	W60656	Rem	1.5	g	2.4/4.0	0.50	0.01	g	g	0.02	1.5	-	-
ECuSn-Af	W60518	Rem	g	0.05-0.35	g	0.25	0.01	g	g	0.02	4.0-6.0	-	0.50
ECuSn-Cf	W60521	Rem	g	0.05-0.35	g	0.25	0.01	g	g	0.02	7.0-9.0	-	0.50
ECuNief	W60715	Rem	1.0-2.5	0.02	0.50	0.40-0.75	-	g	29-33	0.02	g	0.50	0.50
ECuNiAlf	W60632	Rem	0.5-3.5	-	1.5	3.0-6.0	8.5-9.5	g	4.0-6.0	0.02	g	-	0.50
ECuMnNiAlf	W60633	Rem	11-14	-	1.5	2.0-4.0	7.0-8.5	g	1.5-3.0	0.02	g	-	0.50

**NOTES:** a) Single values shown are maximum percentages. Rem = Remainder. b) The weld metal shall be analyzed for the specific elements for which values, or a "g," are shown in this table. If the presence of other elements is indicated in the course of this work, the amount of those elements shall be determined to ensure that their total does not exceed the limit specified for "Other Elements, Total" in the last column of the table. c) ASTM/SAE Unified Numbering System for Metals and Alloys. d) Includes cobalt. e) Sulfur is restricted to 0.015% maximum. f) This AWS classification is intended to correspond to the same classification that appears in AWS A5.6, Specification for Copper and Copper-Alloy Covered Electrodes. Because of revision dates the composition ranges may not be identical. g) These elements must be included in "Other Elements, Total."

## GUIDE TO AWS 5.14 : NICKEL AND NICKEL-ALLOY BARE WELDING ELECTRODES AND RODS

R = welding rods  
E = wire electrodes  
EQ = Strip

**E R**      **Ni1**

Alloy Symbol			C	Mn	Fe	Si	Cu	Ni	Co	Al	Ti	Cr	Nb	Mo	W	Other total
Numerical ISO	Chemical	Numerical AWS	min./max	min./max	min./max.	min./max	min./max	min./max	min./max	min./max	min./max	min./max	min./max	min./max	min./max	
<b>NICKEL</b>																
Ni 2061	NiTi3	ERNi-1	0,15	1,0	1,0	0,7	0,2	≥92,0	-	1,5	2,0-3,5	-	-	-	-	-
<b>NICKEL – COPPER</b>																
Ni 4060	NiCu30Mn3Ti	ERNiCu-7	0,15	2,0-4,0	2,5	1,2	28,0-32,0	≥62,0	-	1,2	1,5-3,0	-	-	-	-	-
Ni 4061	NiCu30Mn3Nb		0,15	4,0	2,5	1,25	28,0-32,0	≥60,0	-	1,0	1,0	-	3,0	-	-	-
Ni 5504	NiCu25Al3Ti	ERNiCu-8	0,25	1,5	2,0	1,0	20,0-	63,0-70,0	-	2,0-4,0	0,3-1,0	-	-	-	-	-
<b>NICKEL – CHROMIUM</b>																
Ni 6072	NiCr44Ti	ERNiCr-4	0,01-0,10	0,20	0,50	0,20	0,50	≥52,0	-	-	0,3-1,0	42,0-46,0	-	-	-	-
Ni 6073	NiCr38AlNbTi	ERNiCr-7	0,03	0,50	1,0	0,30	0,30	≥63,0	1,0	0,75-1,20	0,25-0,75	36,0-39,0	0,25-1,00	0,50	-	P 0,02 S 0,015 B 0,003 Zr 0,02
Ni 6076	NiCr20	ERNiCr-6	0,08-0,25	1,0	2,00	0,30	0,50	≥75,0	-	0,4	0,5	19,0-21,0	-	-	-	-
Ni 6082	NiCr20Mn3Nb	ERNiCr-3	0,10	2,5-3,5	3,0	0,5	0,50	≥67,0	-	-	0,7	18,0-22,0	2,0-3,0	-	-	-
<b>NICKEL – CHROMIUM – IRON</b>																
Ni 6002	NiCr21Fe18Mo9	ERNiCrMo-2	0,05-0,15	2,0	17,0-20,0	1,0	0,5	≥44,0	0,5-2,5	-	-	20,5-23,0	-	8,0-10,0	0,2-1,0	-
Ni 6025	NiCr25Fe10AlY	ERNiCrFe-12	0,05-0,25	0,5	8,0-11,0	0,5	0,1	≥59,0	-	1,8-2,4	0,1-0,2	24,0-26,0	-	-	-	Y 0,05 - 0,12 Zr 0,01-0,1
Ni 6030	NiCr30Fe15Mo5W	ERNiCrMo-11	0,03	1,5	13,0-17,0	0,8	1,0-2,4	≥36,0	5,0	-	-	28,0-31,5	0,3-1,5	4,0-6,0	1,5-4,0	P 0,04 S 0,02
Ni 6045	NiCr28Fe23Si3	ERNiCrFeSi-1	0,05-0,12	1,0	21,0-25,0	2,5-3,0	0,3	≥40,0	1,0	0,30	-	26,0-29,0	-	-	-	P 0,02 S 0,01
Ni 6052	NiCr30Fe9	ERNiCrFe-7	0,04	1,0	7,0-11,0	0,5	0,30	≥54,0	-	1,1	1,0	28,0-31,5	0,10	0,5	-	Al + Ti < 1,5
Ni 6054	NiCr29Fe9	ERNiCrFe-7A	0,04	1,0	7,0-11,0	0,50	0,30	≥52,0	0,12	1,10	1,0	28,0-31,5	0,5	0,50	-	P 0,02 S 0,015
Ni6055	NiCr29Fe5Mo4Nb3	ERNiCrFe-13	0,03	1,0	Bal	0,50	0,30	52,0-62,0	0,10	0,50	0,50	28,0-31,0	2,1-4,0	3,0-5,0	-	P 0,02 S 0,015 B 0,003 Zr 0,02
UNS requested	NiCr30Fe9Nb2		0,04	2,0	7,0-12,0	0,50	0,30	≥54,0	-	0,50	0,50	28,0-31,5	1,0-2,5	0,50	-	-
Ni 6062	NiCr15Fe8Nb	ERNiCrFe-5	0,08	1,0	6,0-10,0	0,3	0,5	≥70,0	-	-	-	14,0-17,0	1,5-3,0	-	-	-
Ni 6176	NiCr16Fe6		0,05	0,5	5,5-7,5	0,5	0,1	≥76,0	0,05	-	-	15,0-17,0	-	-	-	-
Ni 6601	NiCr23Fe15Al	ERNiCrFe-11	0,10	1,0	20,0	0,5	1,0	58,0-63,0	-	1,0-1,7	-	21,0-25,0	-	-	-	-
Ni 6693	NiCr29Fe4Al3	ERNiCrFeAl-1	0,15	1,0	2,5-6,0	0,50	0,50	≥50,0	-	2,5-4,0	1,0	27,0-31,0	0,5-2,5	-	-	P 0,03 S 0,01
Ni 6701	NiCr36Fe7Nb		0,35-0,50	0,5-2,0	7,0	0,5-2,0	-	42,0-48,0	-	-	-	33,0-39,0	0,8-1,8	-	-	-
Ni 6975	NiCr25Fe13Mo6	ERNiCrMo-8	0,03	1,0	10,0-17,0	1,0	0,7-1,2	≥47,0	-	-	0,70-1,5	23,0-2,6	-	5,0-7,0	-	-
Ni 6985	NiCr22Fe20Mo7Cu2	ERNiCrMo-9	0,01	1,0	18,0-21,0	1,0	1,5-2,5	≥40,0	5,0	-	-	21,0-23,5	0,50	6,0-8,0	1,5	-
Ni 7069	NiCr15Fe7Nb	ERNiCrFe-8	0,08	1,0	5,0-9,0	0,50	0,50	≥70,0	-	0,40-1,0	2,0-2,7	14,0-17,0	0,70-1,20	-	-	-
Ni 7092	NiCr15Ti3Mn	ERNiCrFe-6	0,08	2,0-2,7	8,0	0,3	0,5	≥67,0	-	-	2,5-3,5	14,0-17,0	-	-	-	-
Ni 7718	NiCr19Fe19Nb5Mo3	ERNiFeCr-2	0,08	0,3	24,0	0,3	0,3	50,0-55,0	-	0,2-0,8	0,7-1,1	17,0-21,0	4,8-5,5	-	-	B 0,006 P 0,015
Ni 8025	NiFe30Cr29Mo		0,02	1,0-3,0	30,0	0,5	1,5-3,0	35,0-46,0	-	0,2	1,0	27,0-31,0	-	-	-	-
Ni 8065	NiFe30Cr21Mo3	ERNiFeCr-1	0,05	1,0	≥22,0	0,5	1,5-3,0	38,0-46,0	-	0,2	0,60-1,2	19,5-23,5	-	-	-	-
Ni 8125	NiFe26Cr25Mo		0,02	1,0-3,0	30,0	0,5	1,5-3,0	37,0-42,0	-	0,2	1,0	23,0-27,0	-	-	-	-
<b>NICKEL – MOLYBDENUM</b>																
Ni 1001	NiMo28Fe	ERNiMo-1	0,08	1,0	4,0-7,0	1,0	0,50	Min.55,0	2,5	-	-	1,0	-	26,0-30,0	1,0	V 0,20- 0,40 S 0,03
Ni 1003	NiMo17Cr7	ERNiMo-2	0,04-0,08	1,0	5,0	1,0	0,50	Min.65,0	0,20	-	-	6,0-8,0	-	15,0-18,0	0,5	V 0,50 S 0,02
Ni 1004	NiMo25Cr5Fe5	ERNiMo-3	0,12	1,0	4,0-7,0	1,0	0,50	Min.62,0	2,5	-	-	4,0-6,0	-	23,0-26,0	1,0	V 0,60 P 0,04 S 0,03
Ni 1008	NiMo19WCr	ERNiMo-8	0,1	1,0	10,0	0,50	0,50	Min.60,0	-	-	-	0,5-3,5	-	18,0-21,0	2,0-4,0	-
Ni 1009	NiMo20WCr	ERNiMo-9	0,10	1,0	5,0	0,50	0,3-1,3	Min.65,0	-	1,0	-	-	-	19,0-22,0	2,0-4,0	-
Ni 1024	NiMo25	ERNiMo-12	0,03	0,80	2,0	0,80	0,50	Min.59,0	1,0	0,50	-	7,0-9,0	-	24,0-26,0	-	P 0,03 S 0,015

## GUIDE TO AWS 5.14: NICKEL AND NICKEL-ALLOY BARE WELDING ELECTRODES AND RODS

R = welding rods  
E = wire electrodes  
EQ = Strip

E R

NiMo-7

Alloy Symbol			C	Mn	Fe	Si	Cu	Ni	Co	Al	Ti	Cr	Nb	Mo	W	Others d) e)
Numerical ISO	Chemical	Numerical AWS	min./max	min./max	min./max	min./max	min./max	min./max	min./max	min./max	min./max	min./max	min./max	min./max	min./max	
<b>NICKEL – MOLYBDENUM</b>																
Ni 1062	NiMo24Cr8Fe6		0,01	1,0	5,0-8,0	0,10	0,50	Min.62,0	-	0,50	-	6,0-10,0	-	21,0-26,0	-	-
Ni 1066	NiMo28	ERNiMo-7	0,02	1,0	2,0	0,10	0,50	Min.64,0	1,0	-	0,50	1,0	-	26,0-30,0	1,0	P 0,04 S 0,03
Ni 1067	NiMo30Cr	ERNiMo-10	0,01	3,0	1,0-3,0	0,10	0,20	Min.65,0	3,0	0,50	0,20	1,0-3,0	0,20	27,0-32,0	3,0	V 0,20 P 0,03
Ni 1069	NiMo28Fe4Cr	ERNiMo-11	0,01	1,0	2,0-5,0	0,10	0,50	Min.65,0	1,0	0,1-0,5	0,30	0,5-1,5	0,50	26,0-30,0	-	-
<b>NICKEL – CHROMIUM – MOLYBDENUM</b>																
(Ni 6007)		ERNiCrMo-1	0,08	1,0	4,0-7,0	1,0	0,5	Rem	2,5	-	-	1,0	-	26,0-30,0	1,0	P 0,025 S 0,03 V 0,20-0,40
(Ni 6002)		ERNiCrMo-2	0,04-0,08	1,0	5,0	1,0	0,5	Rem	0,20	-	-	6,0	-	15,0-18,0	0,5	P 0,015 S 0,02 V 0,50
Ni 6012	NiCr22Mo9		0,05	1,0	3,0	0,5	0,5	Min. 58,0	-	0,4	0,4	20,0-23,0	1,5	8,0-10,0	-	-
Ni 6022	NiCr21Mo13Fe4W3	ERNiCrMo-10	0,01	0,5	2,0-6,0	0,08	0,5	Min. 49,0	2,5	-	-	20,0-22,05	-	12,5-14,5	2,5-3,5	V 0,3
Ni 6035	NiCr33Mo8	ERNiCrMo-22	0,05	0,5	2,0	0,6	0,30	Min. 60,0	1,00	-	-	-	-	-	-	-
Ni 6057	NiCr30Mo11	ERNiCrMo-16	0,02	1,0	2,0	1,0	-	Min. 53,0	-	-	-	29,0-31,0	-	10,0-14,5	-	V 0,4 P 0,04 S 0,03
Ni 6058	NiCr21Mo20	ERNiCrMo-19	0,01	0,5	1,5	0,10	0,50	Min. 52,0	0,3	0,4	-	20,0-23,0	-	19,0-21,0	0,3	N 0,02 - 0,15 P 0,015 S 0,01
Ni 6059	NiCr23Mo16	ERNiCrMo-13	0,01	0,5	1,5	0,10	0,5	Min. 56,0	0,3	0,1-0,4	0,5	22,0-24,0	-	15,0-16,5	-	V 0,3
Ni 6200	NiCr23Mo16Cu2	ERNiCrMo-17	0,01	0,5	3,0	0,08	1,3-1,9	Min. 52,0	2,0	0,5	-	22,0-24,0	-	15,0-17,0	-	P 0,25
Ni 6205	NiCr25Mo16	ERNiCrMo-21	0,03	0,5	1,0	0,50,08	0,2	Min. 55,0	0,2	0,4	0,4	24,0-26,0	-	14,0-16,0	0,3	-
Ni 6276	NiCr15Mo16Fe6W4	ERNiCrMo-4	0,02	1,0	0,08	0,08	0,5	Min. 50,0	2,5	-	-	14,5-16,5	-	15,0-17,0	3,0-4,5	V 0,35 P 0,04 S 0,03
Ni 6452	NiCr20Mo15		0,01	1,0	0,10	0,10	0,5	Min. 56,0	-	-	-	19,0-21,0	0,4	14,0-16,0	-	V 0,4
Ni 6455	NiCr16Mo16Ti	ERNiCrMo-7	0,01	1,0	0,08	0,08	0,5	Min. 56,0	2,0	-	0,7	14,0-18,0	-	14,0-18,0	0,5	P 0,04 S 0,03
Ni 6625	NiCr22Mo9Nb	ERNiCrMo-3	0,1	0,5	0,5	0,5	0,5	Min. 58,0	-	0,4	0,4	20,0-23,0	3,2-4,1	8,0-10,0	-	-
Ni 6650	NiCr20Fe14Mo11WN	ERNiCrMo-18	0,03	0,5	0,5	0,5	0,3	Min. 45,0	1,0	0,05-0,50	-	19,0-21,0	0,05-0,5	9,5-12,5	0,5-2,5	N 0,05 - 0,20 S 0,010 V 0,30
Ni 6660	NiCr22Mo10W3	ERNiCrMo-20	0,03	0,5	0,5	0,5	0,3	Min. 58,0	0,2	0,4	0,4	21,0-23,0	0,20	9,5-11,0	2,0-4,0	-
Ni 6686	NiCr21Mo16W4	ERNiCrMo-14	0,01	1,0	0,08	0,08	0,5	Min. 49,0	-	0,5	0,25	19,0-23,0	-	15,0-17,0	3,0-4,4	S 0,02
Ni 7725	NiCr21Mo8Nb3Ti	ERNiCrMo-15	0,03	0,3	0,20	0,20	-	55,0-59,0	-	0,35	1,0-1,7	19,0-22,5	2,75-4,0	7,5-9,5	-	-
<b>NICKEL – CHROMIUM – COBALT</b>																
Ni 6160	NiCr28Co30Si3	ERNiCoCrSi-1	0,02-0,10	1,0	3,5	2,4-3,0	0,5	Min. 30,0	27,0-32,0	0,40	0,20-0,6	26,0-29,0	0,3	0,7	0,5	P 0,03
Ni 6617	NiCr22Co12Mo9	ERNiCrCoMo-1	0,05-0,15	1,0	3,0	1,0	0,5	Min. 44,0	10,0-15,0	0,8-1,5	0,6	20,0-24,0	-	8,0-10,0	0,5	0,03
Ni 7090	NiCr20Co18Ti3		0,13	1,0	1,5	1,0	0,2	Min. 50,0	15,0-18,0	1,0-2,0	2,0-3,0	18,0-21,0	-	-	-	g
Ni 7263	NiCr20Co20Mo6Ti2		0,04-0,80	1,0	0,7	0,4	0,2	Min. 47,0	19,0-21,0	0,3-0,6	1,9-2,4	19,0-21,0	-	5,6-6,1	-	Al+Ti 2,4 -2,8 f
<b>NICKEL – CHROMIUM – TUNGSTEN</b>																
Ni 6231	NiCr22W14Mo2	ERNiCrWMo-1	0,050-0,15	0,3-1,0	3,0	0,25-0,75	0,50	Min.48	5,0	0,2-0,5	--	20,0-24,0	--	1,0-3,0	13,0-15,0	P:0,03
<b>ANY OTHER AGREED COMPOSITION</b>																
	NiZ h															

## GUIDE TO AWS 5.15: WELDING ELECTRODES AND RODS FOR CAST IRON

"CI" after the hyphen which indicates that these filler metals are intended for cast iron applications.

E = Covered electrode  
S = Solid wire  
T = tubular wire  
R = cast Rod

ER Ni-CI A

Where different compositional limits in filler metals of the same alloy family result in more than one classification, the individual classifications are differentiated by the designators "A" or "B"

CHEMICAL COMPOSITION REQUIREMENTS FOR UNDILUTED WELD METAL FOR SHIELDED METAL ARC AND FLUX CORED ARC WELDING ELECTRODES													
Symbol d) AWS Class	UNS e) Number	Weight Percent a) b) c)											
		C	Mn	Si	P	S	Fe	Ni f)	Mo	Cu g)	Al	Mg	Other max.
<b>Shielded Metal Arc Welding Electrodes SMAW</b>													
E Ni-CI	W82001	2,0	2,5	4,0	-	0,03	8,0	85 min	-	2,5	1,0	-	1,0
E Ni-CI-A	W82003	2,0	2,5	4,0	-	0,03	8,0	85 min	-	2,5	1,0-3,0	-	1,0
E NiFe-CI	W82002	2,0	2,5	4,0	-	0,03	Rem	45-60	-	2,5	1,0	-	1,0
E NiFe-CI-A	W82004	2,0	2,5	4,0	-	0,03	Rem	45-60	-	2,5	1,0-3,0	-	1,0
ENiFeMn-CI	W82006	2,0	10-14	1,0	-	0,03	Rem	35-45	-	2,5	1,0	-	1,0
ENiCu-A	W84001	0,35-0,55	2,3	0,75	-	0,025	3,0-6,0	50-60	-	35-45	-	-	1,0
ENiCu-B	W84002	0,35-0,55	2,3	0,75	-	0,025	3,0-6,0	60-70	-	35-45	-	-	1,0
<b>Flux Cored Arc Welding Electrodes FCAW</b>													
ENiFeT3-CI h)	W82032	2,0	3,5-5,0	1,0	-	0,03	Rem	45-60	-	2,5	1,0	-	1,0
<b>CHEMICAL COMPOSITION REQUIREMENTS FOR CORE WIRE FOR SHIELDED METAL ARC WELDING ELECTRODES</b>													
<b>Shielded Metal Arc Welding Electrodes SMAW</b>													
RCI	F10090	3,2-3,5	0,60-0,75	2,7-3,0	0,50-0,75	0,10	Rem	Trace	Trace	-	-	-	-
RCI-A	F10091	3,2-3,5	0,50-0,70	2,0-2,5	0,20-0,40	0,10	Rem	1,2-1,6	0,25-0,45	-	-	-	-
RCI-B	F10092	3,2-4,0	0,10-0,40	3,2-3,8	0,05	0,015	Rem	0,50	-	-	-	0,04-0,10	Ce0,20
<b>Electrodes for Gas Metal Arc Welding GMAW</b>													
ERNi-CI	N02215	1,0	2,5	0,75	-	0,03	4,0	90 min.	-	4,0	-	-	1,0
ERNiFeMn-CI	N02216	0,50	10-14	1,0	-	0,03	Rem	35-45	-	2,5	1,0	-	1,0

- NOTES:**
- The weld metal, core wire, or the filler metal, as specified, shall be analyzed for the specific elements for which values are shown in this table. If the presence of other elements is indicated, in the course of this work, the amount of those elements shall be determined to ensure that their total does not exceed the limit specified for "Other Elements, Total" in the last column of the table.
  - Single values shown are maximum, unless otherwise noted.
  - "Rem." stands for Remainder.
  - Copper-base filler metals frequently used in the braze welding of cast irons are no longer included in this specification. For information pertaining to these materials see A7.6.
  - SAE/ASTM Unified Numbering System for Metals and Alloys.
  - Nickel plus incidental cobalt.
  - Copper plus incidental silver.
  - No shielding gas shall be used for classification ENiFeT3-CI.

## GUIDE TO AWS 5.16: TITANIUM AND TITANIUM-ALLOY WELDING ELECTRODES AND RODS.

ER

Ti-1

Chemical composition symbols for classification according to				Chemical composition, % b) c)									
Numerical AWS	UNS Number	Numerical ISO	Chemical	C	O	N	H	Fe	Al	V	Sn	Other elements	
ERTI-1	R50100	Ti 0100	Ti99,8	0,03	0,03 -0,10	0,012	0,005	0,08	--	--	--	--	
ERTI-2	R50120	Ti 0120	Ti99,6	0,03	0,08 -0,16	0,015	0,008	0,12	--	--	--	--	
ERTI-3	R50125	Ti 0125	Ti99,5	0,03	0,13 -0,20	0,02	0,008	0,16	--	--	--	--	
ERTI-4	R50130	Ti 0130	Ti99,3	0,03	0,18 -0,32	0,025	0,008	0,25	--	--	--	--	
Alloy group 01 (alloys 0100, 0120, 0125 and 0130) consists of commercially pure titanium. The alloys differ only in respect to their oxygen content. In general, higher oxygen results in higher strength, 550 instead of 425 MPa, but lower ductility. These are alpha alloys.													
ERTI-11	R52251	Ti 2251	TiPd0,2	0,03	0,03 -0,10	0,012	0,005	0,08	--	--	--	Pd: 0,12 -0,25	
ERTI-17	R52253	Ti 2253	TiPd0,06	0,03	0,03 -0,10	0,012	0,005	0,08	--	--	--	Pd: 0,04 -0,08	
ERTI-27	R52255	Ti 2255	TiRu0,1	0,03	0,03 -0,10	0,012	0,005	0,08	--	--	--	Ru: 0,08 -0,14	
Alloy group 22 (alloys 2251, 2253 and 2255) consists of low-oxygen titanium with deliberately small additions of palladium or ruthenium. These elements enhance the corrosion resistance of titanium in reducing acid media, crevice-corrosion situations, and hot oxidizing chloride brines. These are alpha alloys.													
ERTI-7	R52401	Ti 2401	TiPd0,2A	0,03	0,08 -0,16	0,015	0,008	0,12	--	--	--	Pd: 0,12 -0,25	
ERTI-16	R52403	Ti 2403	TiPd0,06A	0,03	0,08 -0,16	0,015	0,008	0,12	--	--	--	Pd: 0,04 -0,08	
ERTI-27	R52405	Ti 2405	TiRu0,1A	0,03	0,08 -0,16	0,015	0,008	0,12	--	--	--	Ru: 0,08 -0,14	
Alloy group 24 (alloys 2401, 2403 and 2405), like Group 22, has deliberately small additions of palladium and ruthenium but consists of a higher oxygen content giving higher strength (500 instead of 425 MPa). These are alpha alloys.													
ERTI-12	R53401	Ti 3401	TiNi0,7Mo0,3	0,03	0,08 -0,16	0,015	0,008	0,15	--	--	--	Mo: 0,2 -0,4 Ni: 0,6 -0,9	
ERTI-15A	R53416	Ti 3416	TiRu0,05Ni0,5	0,03	0,13 -0,20	0,02	0,008	0,16	--	--	--	Ru: 0,04 -0,06 Ni: 0,4 -0,6	
ERTI-13	R53423	Ti 3423	TiNi0,5	0,03	0,03 -0,10	0,012	0,005	0,08	--	--	--	Ru: 0,04 -0,06 Ni: 0,4 -0,6	
ERTI-14	R53424	Ti 3424	TiNi0,5A	0,03	0,08 -0,16	0,015	0,008	0,12	--	--	--	Ru: 0,04 -0,06 Ni: 0,4 -0,6	
ERTI-33	R53443	Ti 3443	TiNi0,45Cr0,15	0,03	0,08 -0,16	0,015	0,008	0,12	--	--	--	Pd: 0,01 -0,02 Ru: 0,02 -0,04 Cr: 0,1 -0,2 Ni: 0,35 -0,55	
ERTI-34	R53444	Ti 3444	TiNi0,45Cr0,15A	0,03	0,13 -0,20	0,02	0,008	0,16	--	--	--	Pd: 0,01 -0,02 Ru: 0,02 -0,04 Cr: 0,1 -0,2 Ni: 0,35 -0,55	
Alloy group 34 (alloys 3401, 3416, 3423, 3443 and 3444) contains about 0,5 % Ni as a deliberate alloying element. Nickel enhances the corrosion resistance of titanium in reducing acid media, crevice-corrosion situations, and hot oxidizing chloride brines. These are alpha alloys.													
ERTI-30	R53531	Ti 3531	TiCo0,5	0,03	0,08 -0,16	0,015	0,008	0,12	--	--	--	Pd: 0,04 -0,08 Co: 0,20 -0,80	
ERTI-31	R53533	Ti 3533	TiCo0,5A	0,03	0,13 -0,20	0,02	0,008	0,16	--	--	--	Pd: 0,04 -0,08 Co: 0,20 -0,80	
Alloy group 35 (alloys 3531 and 3533) contains about 0,5 % Co as a deliberate alloying addition. Cobalt enhances the corrosion resistance of titanium in reducing acid media, crevice-corrosion situations, and hot oxidizing chloride brines. These are alpha alloys.													
AMS 4952	R54621	Ti 4621	TiAl6Zr4Mo2Sn2	0,04	0,30	0,015	0,15	0,05	5,50 -6,50	--	1,80 -2,20	Zr: 3,60 -4,40 Mo: 1,80 -2,20 Cr: 0,25 max	
Alloy group 46 (alloy 4621) contains about 6 % aluminium, and 2 % tin, and the additions of 4 % zirconium, and 2 % molybdenum allow it to reach ultimate tensile strength of about 1 000 MPa. It is a near alpha alloy.													
AMS 4955	R54810	Ti 4810	TiAl8V1Mo1	0,08	0,12	0,05	0,01	0,30	7,35 -8,35	0,75 -1,25	--	Mo: 0,75 -1,25	
Alloy group 48 (alloy 4810) contains about 8 % aluminium, 1 % vanadium and 1 % molybdenum. This is a near-alpha alloy, having an ultimate tensile strength of around 950 MPa.													
ERTI-32	R55112	Ti 5112	TiAl5V1Sn1Mo1Zr1	0,03	0,05 -0,10	0,012	0,008	0,20	4,5 -5,5	0,6 -1,4	0,6 -1,4	Mo: 0,6 -1,2 Zr: 0,6 -1,4 Si: 0,06 -0,14	
Alloy group 51 (alloy 5112) contains about 5 % aluminium, 1 % vanadium, 1 % tin, 1 % molybdenum and 1 % zirconium. This is an alpha + beta alloy, having an ultimate tensile strength of around 850 MPa.													
-	-	Ti 6320	TiAl3V2,5	0,03	0,08 -0,16	0,020	0,008	0,25	2,5 -3,5	2,0 -3,0	--	--	
ERTI-9	R56321	Ti 6321	TiAl3V2,5A	0,03	0,06 -0,12	0,012	0,005	0,20	2,5 -3,5	2,0 -3,0	--	--	
ERTI-28	R56324	Ti 6324	TiAl3V2,5Ru	0,03	0,06 -0,12	0,012	0,005	0,20	2,5 -3,5	2,0 -3,0	--	Ru: 0,08 -0,14	
ERTI-18	R56326	Ti 6326	TiAl3V2,5Pd	0,03	0,06 -0,12	0,012	0,005	0,20	2,5 -3,5	2,0 -3,0	--	Pd: 0,04 -0,08	
Alloy group 63 (alloys 6320, 6321, 6324 and 6326) contains about 3 % aluminium and 2,5 % vanadium. These are alpha + beta alloys, having an ultimate tensile strength of around 700 MPa.													
ERTI-5	R56400	Ti 6402	TiAl6V4B	0,05	0,12 -0,20	0,030	0,15	0,22	5,50 -6,75	3,50 -4,50	--	--	
ERTI-23	R56408	Ti 6408	TiAl6V4A	0,03	0,03 -0,11	0,012	0,005	0,20	5,5 -6,5	3,5 -4,5	--	--	
ERTI-25	R56413	Ti 6413	TiAl6V4Ni0,5Pd	0,05	0,12 -0,20	0,030	0,015	0,22	5,5 -6,7	3,5 -4,5	--	Ni: 0,3 -0,8 Pd: 0,04 -0,08	
ERTI-29	R56414	Ti 6414	TiAl6V4Ru	0,03	0,03 -0,11	0,012	0,005	0,20	5,5 -6,5	3,5 -4,5	--	--	
ERTI-24	R56415	Ti 6415	TiAl6V4Pd	0,05	0,12 -0,20	0,030	0,015	0,22	5,5 -6,7	3,5 -4,5	--	--	
Alloy group 64 (alloys 6400, 6402, 6408, 6414 and 6415) contains about 6 % aluminium and 4 % vanadium. These are alpha + beta alloys, having an ultimate tensile strength of around 1 000 MPa.													
ERTI-19	R58641	Ti 8641		0,03	0,06 -0,10	0,015	0,015	0,20	3,0 -4,0	7,5 -8,5	-	Mo:3,5 -4,5 Cr:5,5 -6,5 Zr:3,5 -4,5	
ERTI-20	R58646	Ti 8646		0,03	0,06 -0,10	0,015	0,015	0,20	3,0 -4,0	7,5 -8,5	0,04 -0,08	Mo:3,5 -4,5 Cr:5,5 -6,5 Zr:3,5 -4,5	
ERTI-21	R58211	Ti 8211		0,03	0,10 -0,15	0,012	0,005	0,20 -0,40	-	-	-	Mo:14,0 -16,0 Nb:2,2 -3,2 Si:0,15 -0,25	
ERTI-36	R58451	Ti 8451		0,03	0,06 -0,12	0,02	0,0035	-	-	-	-	Nb: 42,0 -47,0	
ERTI-38	R54251	Ti 4251		0,03	0,20 -0,27	0,02	0,010	3,5 -4,5	2,0 -3,0	-	-	-	

Alloy group 86 (alloys 8441,8641,8646,8211 and 4251) These designation numbers have been proposed for addition to ISO 24034:2005

## NOTES:

- Titanium constitutes the remainder of the composition.
- Single values are maximum.
- Analysis of Fe and the interstitial elements C, O, H, and N shall be conducted on samples of filler metal taken after the filler metal has been reduced to its final diameter and all processing operations have been completed. Analysis of the other elements may be conducted on these same samples or it may have been conducted on samples taken from the ingot or the rod stock from which the filler metal is made. In case of dispute, samples from the finished filler metal shall be the referee method.
- Any element intentionally added (O, Fe, N, and C) must be measured and reported. Residual elements, total, shall not exceed 0.20%, with no single element exceeding 0.05%, except for yttrium, which shall not exceed 0.005%. Residual elements need not be reported unless specifically required by the purchaser. A residual element is any element present in the metal in small quantities that is inherent in the sponge or scrap additions, but not intentionally added. In titanium these elements include, among others, aluminum, vanadium, tin, chromium, molybdenum, niobium, zirconium, hafnium, bismuth, ruthenium, palladium, yttrium, copper, silicon, and cobalt.
- SAE HS-1086/ASTM DS-56, Metals & Alloys in the Unified Numbering System.
- ERTI-9 now conforms to the lower interstitial levels of the previous classification ERTI-9ELI (AWS A5.16/A5.16M:2004).



## GUIDE TO AWS 5.17: CARBON STEEL ELECTRODES AND FLUXES FOR SUBMERGED ARC WELDING

**S** = made solely from crushed slag or is a blend of crushed slag with unused (virgin) flux

**A** = As welded  
**P** = Post weld heat treated (PWHT) 620°C / 1h

**F** = Flux for Submerged Arc welding

**F S 7 A 4 -EC1 HX**

Tensile properties (multi-run)					
	Tensile strength		Min. yield strength		Elongation
	psi	MPa	psi	MPa	%
6	60,000–80,000	(414–551)	48,000	(331)	22
7	70,000–95,000	(483–655)	58,000	(400)	22

Hydrogen content	
Symbol	ml/100g weld metal
H2	2
H4	4
H8	8
H16	16

Impact properties				
	Temperature		Charpy-V impact min.	
	°F	°C	ft-lb	J
0	0	-18	20	27
2	-20	-29	20	27
4	-40	-40	20	27
5	-50	-46	20	27
6	-60	-51	20	27
8	-80	-62	20	27
Z	No requirements			

Chemical composition for composite electrode weld metal (%)						
Classification	C	Mn	Si	S	P	Cu
EC1	0,15	1,80	0,90	0,35	0,035	0,35
ECG	Not specied					

**NOTE:** Single values are maximum

Chemical composition for solid electrodes (%) (extract)						
Classification	C	Mn	Si	S	P	Cu
EL8	0,10	0,25–0,60	0,07	0,030	0,030	0,35
EL8K	0,10	0,25–0,60	0,10–0,25	0,030	0,030	0,35
EL12	0,04–0,14	0,25–0,60	0,10	0,030	0,030	0,35
EM12	0,06–0,15	0,80–1,25	0,10	0,030	0,030	0,35
EM12K	0,05–0,15	0,80–1,25	0,10–0,35	0,030	0,030	0,35
EH12K	0,06–0,15	1,50–2,00	0,25–0,65	0,025	0,025	0,35
EH14	0,10–0,20	1,70–2,20	0,10	0,030	0,030	0,35

**NOTE:** Single values are maximum

GUIDE TO EN AWS 5.18: CARBON STEEL ELECTRODES AND RODS FOR GAS SHIELDED ARC WELDING.

E = Wire electrode  
ER = Designates use as either an electrode or rod (ER), or use

C = Composit (cored) wire  
S = Solid wire

C = CO<sub>2</sub>  
M = 75-80% Ar/Rest CO<sub>2</sub>

Hydrogen Content	
Symbol	ml/100g weld metal
H2	2
H4	4
H8	8
H16	16

**E 70 C -6 M HX**

Classification	Shielding Gas c)	C	Mn	Si	S	P	Ni	Cr	Mo	V	Cu
Multiple Pass Classification a)		C	Mn	Si	S	P	Ni	Cr	Mo	V	Cu
E70C-3X	75-80% Ar/Balance CO <sub>2</sub> oder CO <sub>2</sub>	0,12	1,75	0,90	0,03	0,03	0,5	0,20	0,30	0,08	0,50
E70C-6X	75-80% Ar/Balance CO <sub>2</sub> oder CO <sub>2</sub>	0,12	1,75	0,90	0,03	0,03	0,5	0,20	0,30	0,08	0,50
E70C-G(X)	f	Not Specified h)									
Single Pass Classifications											
E70C-GS(X)	f										

NOTES: see next table

Classification	Shielding Gas	Tensile Strength		Yield Strength b)		Elongatio b)	Charpy V b)	
		psi	MPa	psi	MPa		%	ft-bf
ER70S-2	CO <sub>2</sub> c	70 000	480	58 000	400	22	20 (-20°F)	27 (-30°C)
ER70S-3							20 (0°F)	27 (-20°C)
ER70S-4							Not Required	
ER70S-6							20 (-20°F)	27 (-30°C)
ER70S-7							20 (-20°F)	27 (-30°C)
ER70S-G	d	70 000	480	58 000	400	22	As agreed	
E70C-3X	75-80% Ar/Balance CO <sub>2</sub> or CO <sub>2</sub>	70 000	480	58 000	400	22	20 (0°F)	27 (-20°C)
E70C-6X							20 (-20°F)	27 (-30°C)
E70C-G(X)	d	70 000	480	58 000	400	22	As agreed	
E70C-GS(X)							Not Required	

**NOTES:**

- a) The final X shown in the classification represents a "C" or "M" which corresponds to the shielding gas with which the electrode is classified. The use of "C" designates 100% CO<sub>2</sub> shielding (AWS A5.32 Class SG-C); "M" designates 75-80% Ar/balance CO<sub>2</sub> (AWS A5.32 Class, SG-AC-Y, where Y is 20 of 25). For E70C-G [E48C-G] and E70C-GS [E48C-GS], the final "C" or "M" may be omitted.
- b) Yield strength at 0.2% offset and elongation in 2 in. [50 mm] gage length (or 1.4 in. [36 mm] gage length for the 0.350 in. [9.0 mm] tensile specimen recommended in A4.2 for the optional in A4.2 for the optional acceptance test using gas tungsten arc).
- c) CO<sub>2</sub> p carbon dioxide shielding gas (AWS A5.32 Class SG-C). The use of CO<sub>2</sub> for classification purposes shall not be construed to preclude the use of Ar/CO<sub>2</sub> (AWS A5.32 Class SG-AC-Y) or Ar/O<sub>2</sub> (AWS A5.32 Class SG-AO-X) shielding gas mixtures. A filler metal tested with gas blends, such as Ar/O<sub>2</sub>, or Ar/CO<sub>2</sub> may result in weld metal having higher strength and lower elongation. Testing with 100% argon shielding (AWS A5.32 Class SG-A) is required when classification testing is based on GTAW only (see A4.2 in Annex A).
- d) Shielding gas shall be as agreed to between purchaser and supplier, unless designated by the C or M suffix.
- e) The sum of Ni, Cr, Mo and V shall not exceed 0.50%.
- f) The protective gas composition shall be agreed between the purchaser and the supplier, unless it is marked with the suffix C or M.
- g) The composition shall be specified; the requirements shall be those agreed between the customer and the supplier.
- h) The composition of the weld metal from this classification shall not be specified since electrodes of this classification are intended for single pass welds only. The dilution is usually quite high for such welds.

GUIDE TO AWS 5.20: CARBON STEEL ELECTRODES FOR FLUX CORED ARC WELDING.

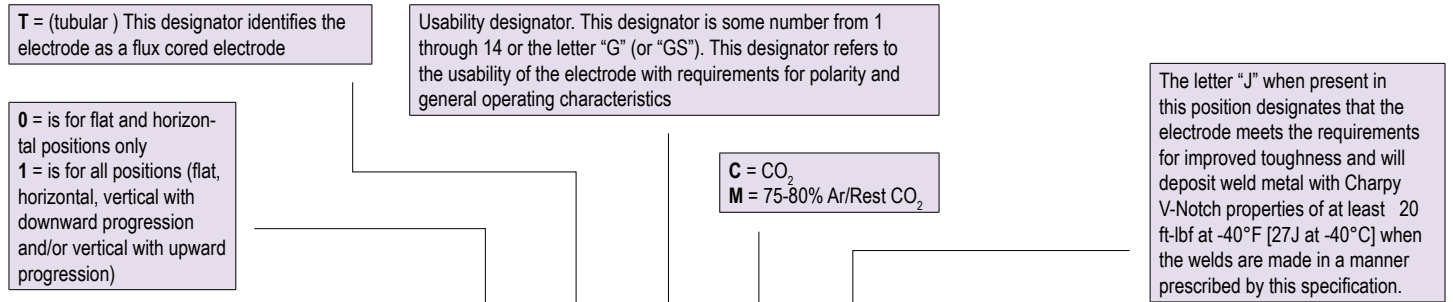

**E** = Wire electrode  
**ER** = Designates use as either an electrode or rod (ER), or use only as an electrode (E)

**E 7(1) T -1 M J D HX**

Hydrogen Content	
Symbol	ml/100g weld metal
H2	2
H4	4
H8	8
H16	16

Classification	C	Mn	Si	S	P	Cr	Ni	Mo	V	Al	Cu
E7XT-1C, -1M	0,12	1,75	0,90	0,03	0,03	0,20	0,50	0,30	0,08	-	0,35
E7XT-5C, -5M											
E7XT-9C, -9M											
E7XT-4	0,30	1,75	0,60	0,03	0,03	0,20	0,50	0,30	0,08	1,8	0,35
E7XT-6											
E7XT-7											
E7XT-8											
E7XT-11											
EXXT-G	-	1,75	0,90	0,03	0,03	0,20	0,50	0,30	0,08	1,80	0,35
E7XT-12C, -12M	0,12	1,60	0,90	0,03	0,03	0,20	0,50	0,30	0,08	-	0,35
E6XT-13	Not Specified										
E7XT-2C, -2M											
E7XT-3											
E7XT-10											
E7XT-13											
E7XT-14											
EXXT-GS											

The letter "D" or "Q" when present in this position indicates that the weld metal will meet supplemental mechanical property requirements with welding done using low heat input, fast cooling rate procedures and using high heat input, slow cooling rate

Classification	Tensile Strength		Yield Strength		Elongation	Ø Charpy V,						
	ksi	MPa	ksi	MPa		ft-bf	J					
E7XT-1C, -1M	70-95	480-655	58	400	22	20 (-20°F)	27 (-30°C)					
E7XT-2C, -2M	Min 70	Min 480	Not Specified									
E7XT-3												
E7XT-4	70-95	480-655	58	400	22							
E7XT-5C, -5M						20 (-20°F)	27 (-30°C)					
E7XT-6						20 (-20°F)	27 (-30°C)					
E7XT-7												
E7XT-8						20 (-20°F)	27 (-30°C)					
E7XT-9C, -9M						20 (-20°F)	27 (-30°C)					
E7XT-10						Min.70	Min 480	Not Specified			Not Specified	
E7XT-11						70-95	480-655	58	400	20		
E7XT-12C, -12M	22	20 (-20°F)	27 (-30°C)									
E6XT-13	Min.60	Min 480	Not Specified				Not Specified					
E7XT-13	Min.70	Min 480										
E7XT-14												
E6XT-G	60-80	441-552	48	331	22							
E7XT-G	70-95	480-655	58	400								
E6XT-GS	Min.60	Min 414	Not Specified									
E7XT-GS	Min.70	Min 480										

## GUIDE TO AWS 5.20 : CARBON STEEL ELECTRODES FOR FLUX CORED ARC WELDING.

### Supplementary information:

**EXXT-1C and EXXT-1M Classifications.** Both have similar type slags and are designed for single and multiple pass welding using DCEP Electrodes of this classification have a rutile base slag and have the ability to produce high deposition rates and used for welding in all positions.

**EXXT-2C and EXXT-2M Classification.** These are essentially EXXT-1C and EXXT-1M with higher manganese or silicon, or both, and are designed primarily for **single pass welding in the flat position** and for welding fillet welds in the horizontal position.

**EXXT-3 Classifications** are **self-shielded**, used on DCEP and have a spraytype transfer. The slag system is designed to make very high welding speeds possible. The electrodes are used for single-pass welds in the flat.

**EXXT-4 Classification.** Electrodes of this classification are **self-shielded**, operate on DCEP, and have a globular type transfer. The **basic slag system** is designed to make very high deposition rates possible and to produce a weld that is very low in sulfur for improved resistance to hot cracking.

**EXXT-5C and EXXT-5M Classifications** are used primarily for single and multiple pass welds in the flat position and for welding fillet welds in the horizontal. These electrodes are characterized by a globular transfer, slightly convex bead contour, and a thin slag that may not completely cover the weld bead. **These electrodes have lime-fluoride base slag.**

**EXXT-7 Classifications** are **self-shielded**. The slag system is designed to allow the larger sizes to be used for high deposition rates in the horizontal and flat positions, and to allow the smaller sizes to be used for all welding positions.

**EXXT-8 Classifications** are **self-shielded**, operate on DCEN, and have a small droplet to spray type transfer. These electrodes are suitable for all welding positions, and the weld metal has very good **low temperature** notch toughness and crack resistance.

**EXXT-9C and EXXT-9M Classifications** especially for out-of-position applications. Increasing the amount of argon in the argon-CO<sub>2</sub> mixture will affect the weld metal analysis and mechanical properties of weld metal deposited by these electrodes, this classification **have a rutile base slag.**

**EXXT-10 Classifications** are **self-shielded**. The electrodes are used for singlepass welds at high travel speeds.

**EXXT-11 Classifications** are **self-shielded**, operate on DCEN, and have a smooth spray-type transfer. They are general purpose electrodes for single- and multiple-pass welding in **all positions**.

**EXXT-12C and EXXT-12M Classifications.** are similar in arc transfer, welding characteristics and deposition rates; however, they have been modified to improve impact toughness and to meet the lower manganese requirements as T-1 (rutile slag) Type. Since welding procedures influence all-weld-metal properties.

**EXXT-13 Classifications** are **self-shielded** and operate on DCEN and are usually welded with a **short-arc transfer**. The slag system is designed so that these electrodes can be used in **all positions** for the **root pass on circumferential pipe welds**.

**EXXT-14 Classifications** are **self-shielded**, operate on DCEN and have a **smooth spray-type transfer**. They are intended for **singlepass welding**. The slag system is designed with characteristics so that these electrodes can be used to weld in **all positions** and also to make welds at **high speed**.

**EXXT-G Classification.** This classification is for multiple pass electrodes that have usability characteristics **not covered by any presently defined classification**.

**EXXT-GS Classification.** This classification is for single pass electrodes that have usability characteristics **not covered by any presently defined classification**.

## GUIDE TO AWS 5.21: BARE ELECTRODES AND RODS FOR SURFACING

ER = Solid wire and Rod Metal and Flux cored wire and Rod

ER

Fe1

Classification f)	UNS g) Number Solid	UNS g) Number Cored	SOLID AND CORED IRON BASE ELECTRODES AND RODS - Chemical composition % (m/m) a) b) c) d) e)									
			C	Mn	Si	Cr	Ni	Mo	V	W	Fe	Others h)
ERFe1	T47000	W74030	0,04-0,020	0,5-2,0	1,0	0,5-3,5	-	1,5	-	-	Rem	1,0
ERFe1a	T74001	W74031	0,05-0,25	1,7-3,5	1,0	0,5-3,5	-	-	-	-	Rem	1,0
ERFe2	T74002	W74032	0,10-0,30	0,5-2,0	1,0	1,8-3,8	1,0	1,0	0,35	-	Rem	1,0
ERFe3	T74003	W74033	0,50-0,80	0,5-1,5	1,0	4,0-8,0	-	1,0	-	-	Rem	1,0
ERFe5	T74005	W74035	0,50-0,80	1,5-2,5	0,90	1,5-3,0	-	-	-	-	Rem	1,0
ERFe6	T75006	W77530	0,6-1,0	0,4-1,0	1,0	3,0-5,0	-	7,0-9,5	0,5-1,5	0,5-1,5	Rem	1,0
ERFe8	T75008	W77538	0,30-0,80	1,0-2,0	1,0	4,0-8,0	-	1,0-2,0	0,50	1,0-2,0	Rem	1,0
ERFeMn-C	-	W79230	0,5-1,0	12-16	1,3	2,5-5,0	2,5-5,0	-	-	-	Rem	1,0
ERFeMn-F	-	W79630	0,7-1,1	16-22	1,3	2,5-5,0	1,0	-	-	-	Rem	1,0
ERFeMn-G	-	W79231	0,5-1,0	12-16	1,3	2,5-5,0	1,0	-	-	-	Rem	1,0
ERFeMn-H	-	W79232	0,30-0,80	12-16	1,3	4,5-7,5	2,0	-	-	-	Rem	1,0
ERFeMnCr	-	W79730	0,25-0,75	12-18	1,3	11-16	2,0	2,0	-	-	Rem	1,0
ERFeCr-A	-	W74531	1,5-3,5	0,5-1,5	2,0	8,0-14,0	-	1,0	-	-	Rem	1,0
ERFeCr-A1A	-	W74530	3,5-5,5	4,0-6,0	0,5-2,0	20-25	-	0,50	-	-	Rem	1,0
ERFeCr-A3A	-	W74533	2,5-3,5	0,5-2,0	0,5-2,0	14-20	-	-	-	-	Rem	1,0
ERFeCr-A4	-	W74534	3,5-4,5	1,5-3,5	1,5	23-29	-	1,0-3,0	-	-	Rem	1,0
ERFeCr-A5	-	W74535	1,5-2,5	0,5-1,5	2,0	24-32	4,0	4,0	-	-	Rem	1,0
ERFeCr-A9	-	W74539	3,5-5,0	0,5-1,5	2,5	24-30	-	-	-	-	Rem	1,0
ERFeCr-A10	-	W74540	5,0-7,0	0,5-2,5	1,5	20-25	-	-	-	-	Rem	1,0

## NOTES:

- a) Covered composite iron base electrodes that were included in AWS A5.21-80, Specification for Bare Surfacing Electrodes and Rods, have been deleted. They now appear in AWS A5.13:2000, Specification for Surfacing Electrodes for Shielded Metal Arc Welding.
- b) Single values are maximum. Rem p Remainder
- c) Electrodes and rods shall be analyzed for the specific elements for which values are shown in this table. If the presence of other elements is indicated in the course of this work, the amount of those elements shall be determined to ensure that their total does not exceed the limit specified for "Other Elements, Total" in the last column of the table.
- d) Sulfur and phosphorus contents shall not exceed 0.035% each.
- e) For solid electrodes and rods, composition is that of the electrode itself or the stock from which it was made. For metal cored or flux cored electrodes, the composition is that of a weld deposit prepared in accordance with 9.3 or 9.4.
- f) For metal cored and flux cored composite (tubular) electrodes and rods, insert "C" in the classification designation just after the "R."
- g) ASTM DS-56/SAE HS-1086 Unified Numbering System for Metals and Alloys.
- h) Aluminum and magnesium contents of weld metal deposited by self-shielding electrodes shall not be included in the value of "Other Elements, Total."

Alloy type	UNS Number d)	SOLID COBALT AND NICKEL BASE BARE ELECTRODES AND RODS Chemical composition % (m/m) a) b) c) d) e)											
		C	Mn	Si	Cr	Ni	Mo	Fe	W	Co	B	V	others
ERCoCr-A	R30006	0,9-1,4	1,0	2,0	26-32	3,0	1,0	3,0	3,0-6,0	Rem	-	-	0,50
ERCoCr-B	R30012	1,2-1,7	1,0	2,0	26-32	3,0	1,0	3,0	7,0-9,5	Rem	-	-	0,50
ERCoCr-C	R30001	2,0-3,0	1,0	2,0	26-33	3,0	1,0	3,0	11,0-14,0	Rem	-	-	0,50
ERCoCr-E	R30021	0,15-0,45	1,5	1,5	25-30	1,5-4,0	4,5-7,0	3,0	0,50	Rem	-	-	0,50
ERCoCr-F	R30002	1,5-2,0	1,0	1,5	24-27	21-24	1,0	3,0	11-13	Rem	-	-	0,50
ERCoCr-G	R30014	3,0-4,0	1,0	2,0	24-30	4,0	1,0	3,0	12-16	Rem	-	-	0,50
ERNiCr-A	N99644	0,20-0,60	-	1,2-4,0	6,5-14,0	Rem	-	1,0-3,5	-	-	1,5-3,0	-	0,50
ERNiCr-B	N99645	0,30-0,80	-	3,0-5,0	9,5-16,0	Rem	-	2,0-5,0	-	-	2,0-4,0	-	0,50
ERNiCr-C	N99646	0,50-1,00	-	3,5-5,5	12-18	Rem	-	3,0-5,5	-	-	2,5-4,5	-	0,50
ERNiCr-D	N99647	0,6-1,1	-	4,0-6,6	8,0-12,0	Rem	-	1,0-5,0	1,0-3,0	0,10	0,35-0,60	-	Sn:0,50-0,9
ERNiCr-E	N99648	0,1-0,5	-	5,5-8,0	15-20	Rem	-	3,5-7,5	0,5-1,5	0,10	0,7-1,4	-	0,50
ERNiCrMo-5A	N10006	0,12	1,0	1,0	14-18	Rem	14-18	4,0-7,0	3,0-5,0	-	-	0,40	0,50
ERNiCrFeCo	F46100	2,5-3,0	1,0	0,6-1,5	25-30	10-33	7-10	20-25	2,0-4,0	10-15	-	-	0,50

Legierungstyp	UNS Nummer d)	METAL CORE COBALT AND NICKEL BASE ELECTRODES AND RODS Chemical composition % (m/m) a) b) c) d) e)											
		C	Mn	Si	Cr	Ni	Mo	Fe	W	Co	B	V	andere
ERCoCr-A	W73036	0,7-1,4	2,0	2,0	25-32	3,0	1,0	5,0	3,0-6,0	Rem	-	-	1,0
ERCoCr-B	W73042	1,2-2,0	2,0	2,0	25-32	3,0	1,0	5,0	7,0-10,0	Rem	-	-	1,0
ERCoCr-C	W73031	2,0-3,0	2,0	2,0	25-33	3,0	1,0	5,0	11,0-14,0	Rem	-	-	1,0
ERCoCr-E	W73041	0,15-0,40	2,0	1,5	25-30	1,5-4,0	4,5-7,0	5,0	0,50	Rem	-	-	1,0
ERCoCr-G	W73032	3,0-4,0	1,0	2,0	24-30	4,0	1,0	5,0	12,0-16,0	Rem	-	-	1,0
ERNiCr-A	W89634	0,20-0,60	-	1,2-4,0	6,5-14,0	Rem	-	1,0-3,5	-	-	1,5-3,0	-	1,0
ERNiCr-B	W89635	0,30-0,80	-	3,0-5,0	9,5-16,0	Rem	-	2,0-5,0	-	-	2,0-4,0	-	1,0
ERNiCr-C	W89636	0,50-1,00	-	3,5-5,5	12-18	Rem	-	3,0-5,5	-	-	2,5-4,5	-	1,0
ERNiCrMo-5A	W80036	0,12	1,0	2,0	14-18	Rem	14-18	4,0-7,0	3,0-5,0	-	-	0,40	1,0
ERNiCrFeCo	W83032	2,2-3,0	1,0	2,0	25-30	10-33	7-10	20-25	2,0-4,0	10,0-15,0	-	-	1,0

## Notes:

- a) Individual values are maximum values. Rem = remainder
- b) Electrodes and rods must be analyzed for the specific elements for which values are given in this table. If, in the course of this work, the presence of other elements is detected during the course of this work, the amount of these elements must be determined - ensure that their sum does not exceed the limit given for „Other elements, total“ in the last column of the table. the last column of the table.
- c) The sulfur and phosphorus content shall not exceed 0.03% each.
- d) ASTM/SAE Unified Numbering System for Metals and Alloys.
- e) Includes incidental cobalt.

## GUIDE TO EN AWS 5.21: BARE ELECTRODES AND RODS FOR SURFACING

Alloy typ	UNS Number solid	UNS Number cord	Copper base solid wire, cored wire and rods chemical composition % (m/m) a) b) c) d) e)									
			Fe	Cu	Al	Zn	Si	Pb	Sn	P	Mn	other
ERCuAl-A2g	C61800	W60618	0.5-1.5	Rem	8.5-11.0	0.02	0.10	0.02	-	-	-	0,50
ERCuAl-A3g	C62400	W60624	2.0-4.5	Rem	10.0-11.5	0.10	0.10	0.02	-	-	-	0,50
ERCuAl-C	C62580	W60626	3.0-5.0	Rem	12-13	0.02	0,04	0.02	-	-	-	0,50
ERCuAl-D	C62581	W61626	3.0-5.0	Rem	13-14	0.02	0,04	0.02	-	-	-	0,50
ERCuAl-E	C62582	W62626	3.0-5.0	Rem	14-15	0.02	0,04	0.02	-	-	-	0,50
ERCuSi-Ag	C65600	W60657	0.50	Rem	0.01	1,0	2.8-4.0	0.02	1.0	-	1,50	0,50
ERCuSn-Ag	C51800	W60518	-	Rem	0.01	-	-	0.02	4.0-6.0	0.10-0.35	-	0,50
ERCuSn-D	C52400	W60524	-	Min. 88,5	0.01	-	-	0,05	9.0-11.0	0.10-0.35	-	0,50

**NOTES:**

- a) Individual values given are maximum percentages. Rem = remainder.
- b) Electrodes and rods must be analyzed for the specific elements for which values are given in this table. If, during the course of this work, the presence of other elements is determined, the amount of these elements must be determined - ensure that their sum does not exceed the limit given for „Other Elements, Total“ in the last column of the table.
- c) For solid electrodes and rods, the composition is that of the electrode itself or the material from which it is made.
- d) For composite metal core and flux cored electrodes and wires, insert „C“ immediately after „R“ in the classification designation.
- e) ASTM/SAE Unified Number System for Metals and Alloys.
- f) Sulfur content shall not exceed 0.015%.
- g) These AWS classifications shall conform to the classification appearing in AWS A5.7, Specification for Copper and Copper Alloy Bare Welding Rods and Electrodes. Due to -possible ongoing revisions, the composition ranges may not be identical.

**Supplementary information:****Solid Electrodes or Rods.**

Chemical analysis of the filler metal itself (or the stock from which it is made) is the only test required for classification of a product under this specification.

**Metal Cored and Flux Cored Composite (Tubular) Electrodes and Rods.**

Chemical analysis of a pad of undiluted weld metal, as shown in Fig. 1, or a fused sample as agreed upon by the supplier and purchaser, is the only test required for classification. In case of dispute, the weld pad described in Norm.

**Tungsten Carbide Rods.**

The amount and mesh size distribution of the tungsten carbide granules shall be determined. Chemical analysis of the tungsten carbide granules shall be determined.

**ERFe-1, ERFe-1A, and ERFe-2 Electrodes.**

Deposits made with these electrodes and rods are a machinery-grade steel suitable for application on carbon and alloy steels. With care, they can be applied crack-free. hardness generally is in the range of **25-50 HRC** with ERFe-2.

**ERFe-3 Electrodes and Rods.**

Deposited by these electrodes and rods is an air-hardening tool steel type with high room-temperature hardness **55-60 HRC**.

**ERFe-5 Electrodes and Rods.**

Electrodes and rods deposit a cold work tool steel weld metal. Hardness as deposited should be in the range of **50-55 HRC** Weld metal deposited by ERFe-5 electrodes is air hardening.

**ERFe-6 Electrodes and Rods.**

Deposited by ERFe-6 electrodes and rods is a high-speed tool steel with a hardness in the range of **60 HRC or higher**. The deposit maintains a **high degree** of hardness to 1100°F (593°C).

**ERFe-8 Electrodes and Rods.**

Deposited by ERFe-8 electrodes and rods is similar to an H12 hot work tool steel with an as-deposited hardness of **HRC 54-60** The microstructure consists of martensite plus alloy carbides to produce a tough, hard deposit on either carbon or low-alloy steel base metal, **crack-free deposits**.

**ERFeMn Series Electrodes and Rods (except ERFeMnCr).**

Deposits made with these electrodes and rods nominally contain **14% manganese**, although they may vary from 12 to 22%. The additions of other alloys, such as **4% nickel**, are made to give more stability to the austenite. Chromium and molybdenum can also be added to increase the yield strength. As deposited, surfaces generally are no harder than **HRC 20**, but can work harden to **HRC 55**.

**ERFeMnCr Electrodes and Rods.**

Deposited by ERFeMnCr electrodes have similar characteristics to those of the austenitic manganese deposits. These deposits **cannot be flame cut**

**ERFeCr-A Electrodes and Rods.**

Deposited by these electrodes and rods will contain moderate amounts of **chromium carbides in a high-carbon austenitic matrix** Two layers are recommended to maintain uniform hardness and deposit composition ERFeCr-A electrodes may be applied to carbon, low-alloy, **austenitic manganese steel and austenitic stainless steel** base metals.

**ERFeCr-A1A and ERFeCr-A4 Electrodes and Rods.**

Deposited by these electrodes and rods will contain massive **chromium carbides** in an austenitic matrix providing excellent wear resistance and fair toughness.

## GUIDE TO AWS 5.21: BARE ELECTRODES AND RODS FOR SURFACING

**Supplementary information:****ERFeCr-A3A Electrodes and Rods.**

The microstructure of weld metal deposited by electrodes and rods resembles that of **white cast iron**.

**ERFeCr-A5 Electrodes and Rods.**

The weld deposit contains **chromium carbide** in an **austenitic matrix**. The **nonmagnetic** weld metal has fair machinability.

**ERFeCr-A9 Electrodes and Rods.**

The deposit contains **hexagonal chromium carbides** in an **austenitic matrix** with a hardness of **50-60 HRC**.

**ERFeCr-A10 Electrodes and Rods.**

The deposited by these electrodes and rods contains massive **hexagonal carbides** in an **austenite-carbide matrix**. The deposit has a hardness of **HRC 58-63** which is maintained to a **temperature of 1400°F (760°C)**. The deposit **cannot be flame cut. Finishing is by grinding only**.

**ERCoCr-A Electrodes and Rods.**

The deposited by electrodes and rods are characterized by a **hypoeutectic structure**, consisting of a network of about **13% eutectic chromium carbides** distributed in a **cobaltchromium-tungsten solid solution matrix**, **hot hardness up to a maximum of 1200°F (650°C)**.

**ERCoCr-B Electrodes and Rods.**

The deposited by ERCoCr-B electrodes and rods is similar in composition to deposits made using ERCoCr-A. A slightly **higher percentage (approximately 16%) of carbides**.

**ERCoCr-C Electrodes and Rods.**

This alloy has a higher percentage (**approximately 19%**) of carbides.

**ERCoCr-E Electrodes and Rods.**

Deposits are resistant to **thermal shock and oxidizing and reducing atmospheres**, e very good strength and ductility in temperatures up to **2100°F (1150°C)**.

**ERCoCr-F Electrodes and Rods.**

The differs from the other cobalt chrome tungsten alloys due to the addition of over **20% nickel**. This alloy was developed to impart additional oxidation and corrosion resistance, especially where lead additives are made to automotive engine fuels.

**ERCoCr-G Electrodes and Rods.**

Have higher carbon and tungsten version of ERCoCr-C that imparts excellent abrasion resistance under high loads. The increase in the volume fraction of primary carbides also increases the average hardness and adhesive wear resistance.

Typical hardness values for multilayer welds made using cobalt base electrodes and rods are as follows:

**CoCr-A 23-47 HRC, CoCr-B 34-47 HRC, CoCr-C 43-58 HRC, CoCr-E 20-35 HRC, CoCr-F 32-46 HRC, CoCr-G 52-60 HRC**

**ERNiCr-A, -B, and -C Electrodes and Rods.**

Undiluted weld metals of these compositions exhibit a structure consisting of borides and chromium carbides in a **nickel-rich matrix**. The nickel-base and high-chromium content gives these deposits good heat and corrosion resistance. The deposited by these electrodes and rods **flows very easily**, has very high abrasion resistance, and normally **takes on a high polish**.

**ERNiCrMo-5A Electrodes and Rods.**

Weld metal of this composition is a solid **solution strengthened alloy** with a **relatively low weight-percent carbide phase**. The resultant deposit is **tough and work hardening**. Deposits have the ability to **retain hardness to 1400°F (760°C)**. Deposits are machinable with **high-speed tool bits** and have excellent resistance to **high-temperature wear and impact**.

**ERNiCrFeCo Electrodes and Rods.**

Filler metal deposited by these electrodes is a **nickel-chromium-iron-cobalt base alloy** containing a fairly **large volume fraction of hypereutectic chromium carbides** distributed throughout the microstructure.

**ERNiCr-D and E Electrodes and Rods.**

Undiluted weld metals of these compositions with Si/B greater than 3.3 exhibit a structure consisting of a **nickel solid solution**, a **binary eutectic of nickel solid solution and nickel silicide**; and a ternary eutectic of nickel solid solution, nickel silicide and nickel boride. There are also carbide and boride particles dispersed in the matrix.

**ERCuAl-A2**

Filler metal is used for building up bearing surfaces between the hardness range of **130-150 HB**.

**ERCuAl-A3**

Filler metal deposits produce a deposit of high strength and good ductility with a nominal hardness of **166 HB**.

**ERCuAl-C, ERCuAl-D, ERCuAl-E**

Filler metals have excellent **wear-resisting characteristics** and are used where extreme wear and high pressure are encountered in service

**ERCuAl-C 250-290 HB, ERCuAl-D 310-350 HB, ERCuAl-E 340-380 HB, ERCuSi-A** (copper-silicon)

Filler metal is used primarily for corrosion-resistant surfaces.

**ERCuSn-A, ERCuSn-D** (copper-tin) filler metal is primarily used to build-up **bearing surfaces** where **lower hardness is required**.

**Tungsten Carbide Electrodes and Rods. Characteristics.** Tungsten carbide electrodes and rods classified in this **specification contain 60% by weight of tungsten carbide granules**. The WC1 carbide is a mixture of WC and W2C. The **W2C carbide is microcrystalline WC**.

Hardness of the **matrix** of the deposit can be **varied from 30-60 HRC** depending on welding technique. Hardness of individual carbide **particles typically is about 2400 HV20**.



WELDING KNOW-HOW - STANDARD

GUIDE TO AWS 5.22: STAINLESS STEEL ELECTRODES FOR FLUX CORED ARC WELDING AND STAINLESS STEEL FLUX CORED RODS FOR GAS TUNGSTEN ARC WELDING

E = Wire electrode  
R = Wire rod

T = (tubular) This designator identifies the electrode as a flux cored electrode

0 = Is for flat and horizontal positions only  
1 = Is for all positions (flat, horizontal, vertical with downward progression and/or vertical with upward progression and overhead)

1 = CO<sub>2</sub>  
3 = None (self-shielded)  
4 = 75-80% Ar/Rest CO<sub>2</sub>  
5 = 100% Argon  
G = Not Specified

E 307 T 1 -1

Symbols and all-weld metal chemical composition requirements of gas shielded flux cored electrodes

Classification ISO	Classification AWS	Chemical composition % by mass a) b) DE												
		Sh.- gas	C	Mn	Si	Pc	Sc	Cr	Ni	Mo	Nb+Tad	Cu	N	Others
307	E307TX-X	C1 M12 M21, Z	0,13	3.30-4.75	1,0	0,04	0,03	18.0-20.5	9.0-10.5	0.5-1.5	-	0,75 (0,5 AWS)	-	-
308	E308TX-X	C1 M12 M21, Z	0,08	0.5-2.5	1,0	0,04	0,03	18.0-21.0	9.0-11.0	0,5	-	0,75 (0,5 AWS)	-	-
308L	E308LTX-X	C1 M12 M21, Z	0,04	0.5-2.5	1,0	0,04	0,03	18.0-21.0	9.0-11.0	0,5	-	0,75 (0,5 AWS)	-	-
308H	E308HTX-X	C1 M12 M21, Z	0,04-0,08	0.5-2.5	1,0	0,04	0,03	18.0-21.0	9.0-11.0	0,5	-	0,75 (0,5 AWS)	-	-
308Mo	E308MoTX-X	C1 M12 M21, Z	0,08	0.5-2.5	1,0	0,04	0,03	18.0-21.0	9.0-11.0	2.0-3.0	-	0,75 (0,5 AWS)	-	-
308LMo	E308LMoTX-X	C1 M12 M21, Z	0,04	0.5-2.5	1,0	0,04	0,03	18.0-21.0	9.0-12.0	2.0-3.0	-	0,75 (0,5 AWS)	-	-
309	E309TX-X	C1 M12 M21, Z	0,10	0.5-2.5	1,0	0,04	0,03	0 22.0-25.0	12.0-14.0	0,5	-	0,75 (0,5 AWS)	-	-
	E309LCbTX-X	C1 M12 M21, Z	0,04	0.5-2.5	1,0	0,04	0,03	0 22.0-25.0	12.0-14.0	0,5	-	0,75 (0,5 AWS)	-	-
309L	E309LTX-X	C1 M12 M21, Z	0,04	0.5-2.5	1,0	0,04	0,03	0 22.0-25.0	12.0-14.0	0,5	-	0,75 (0,5 AWS)	-	-
309H		C1 M12 M21, Z	0,04-0,10	0.5-2.5	1,0	0,04	0,03	0 22.0-25.0	12.0-14.0	0,75	-	0,75 (0,5 AWS)	-	-
309Mo	E309MoTX-X	C1 M12 M21, Z	0,12	0.5-2.5	1,0	0,04	0,03	21.0-25.0	12.0-16.0	2.0-3.0	-	0,75 (0,5 AWS)	-	-
309LMo	E309LMoTX-X	C1 M12 M21, Z	0,04	0.5-2.5	1,0	0,04	0,03	21.0-25.0	12.0-16.0	2.0-3.0	-	0,75 (0,5 AWS)	-	-
309LNb		C1 M12 M21, Z	0,04	0.5-2.5	1,0	0,04	0,03	0 22.0-25.0	12.0-14.0	0,75	0,7 - 1,0	0,75 (0,5 AWS)	-	-
309LNiMo	E309LNiMoTX-X	C1 M12 M21, Z	0,04	0.5-2.5	1,0	0,04	0,03	20.5-23.5	15.0-17.0	2.5-3.5	-	0,75 (0,5 AWS)	-	-
310	E310TX-X	C1 M12 M21, Z	0,20	1.0-2.5	1,0	0,04	0,03	25.0-28.0	20.0-22.5	0,5	-	0,75 (0,5 AWS)	-	-
312	E312TX-X	C1 M12 M21, Z	0,15	0.5-2.5	1,0	0,04	0,03	28.0-32.0	8.0-10.5	0,5	-	0,75 (0,5 AWS)	-	-
316	E316TX-X	C1 M12 M21, Z	0,08	0.5-2.5	1,0	0,04	0,03	17.0-20.0	11.0-14.0	2.0-3.0	-	0,75 (0,5 AWS)	-	-
316L	E316LTX-X	C1 M12 M21, Z	0,04	0.5-2.5	1,0	0,04	0,03	17.0-20.0	11.0-14.0	2.0-3.0	-	0,75 (0,5 AWS)	-	-
316H		C1 M12 M21, Z	0,04-0,08	0.5-2.5	1,0	0,04	0,03	17.0-20.0	11.0-14.0	2.0-3.0	-	0,75 (0,5 AWS)	-	-
316LCu		C1 M12 M21, Z	0,04	0.5-2.5	1,0	0,04	0,03	17.0-20.0	11.0-16.0	1,25-2,75	-	0,75 (0,5 AWS)	-	-
317		C1 M12 M21, Z	0,08	0.5-2.5	1,0	0,04	0,03	13.0-15.0	12.0-14.0	3.0-4.0	-	0,75 (0,5 AWS)	-	-
317L	E317LTX-X	C1 M12 M21, Z	0,04	0.5-2.5	1,0	0,04	0,03	18.0-21.0	12.0-14.0	3.0-4.0	-	0,75 (0,5 AWS)	-	-
318		C1 M12 M21, Z	0,08	0.5-2.5	1,0	0,04	0,03	18.0-20.5	11.0-14.0	2.0-3.0	8 x C min 1,0 max	0,75 (0,5 AWS)	-	-
347	E347TX-X	C1 M12 M21, Z	0,08	0.5-2.5	1,0	0,04	0,03	18.0-21.0	9.0-11.0	0,75	8 x C min 1,0 max	0,75 (0,5 AWS)	-	-
347L		C1 M12 M21, Z	0,04	0.5-2.5	1,0	0,04	0,03	18.0-21.0	9.0-11.0	0,75	8 x C min 1,0 max	0,75 (0,5 AWS)	-	-
347H		C1 M12 M21, Z	0,04-0,08	0.5-2.5	1,0	0,04	0,03	18.0-21.0	9.0-11.0	0,75	8 x C min 1,0 max	0,75 (0,5 AWS)	-	-
409	E409TX-X	C1 M12 M21, Z	0,10	0,80	1,0	0,04	0,03	10.5-13.5	0,6	0,75	-	0,75 (0,5 AWS)	-	Ti: 10xC 1,5 max
409Nb		C1 M12 M21, Z	0,10	1,2	1,0	0,04	0,03	10.5-13.5	0,6	0,75	8 x C min 1,5 max	0,75 (0,5 AWS)	-	-
410	E410TX-X	C1 M12 M21, Z	0,12	1,2	1,0	0,04	0,03	11.5-13.5	0,6	0,75	-	0,75 (0,5 AWS)	-	-
410NiMo	E410NiMoTX-X	C1 M12 M21, Z	0,06	1,0	1,0	0,04	0,03	11.5-12.5	4.0-5.0	0.40-0.7	-	0,75 (0,5 AWS)	-	-
	E410NiTiTX-X	C1 M12 M21, Z	0,04	0,7	0,5	0,03	0,03	11.0-12.0 3	3.6-4.5	0,5	-	0,75 (0,5 AWS)	-	-
430	E430TX-X	C1 M12 M21, Z	0,10	1,0	1,0	0,04	0,03	15.0-18.0	0,6	0,75	-	0,75 (0,5 AWS)	-	-
430Nb		C1 M12 M21, Z	0,10	1,2	1,0	0,04	0,03	15.0-18.0	0,6	0,75	0,5-1,5	0,75 (0,5 AWS)	-	-
16-8-2		C1 M12 M21, Z	0,10	0.5-2.5	1,0	0,04	0,03	14.5-17.5	7.5-9.5	1.0-2.0	-	0,75 (0,5 AWS)	-	Cr+Mo=18,5 max
	E502TX-X	C1 M12 M21, Z	0,10	1,2	1,0	0,04	0,03	4.0-6.0	0,40	0.45-0.65	-	0,75 (0,5 AWS)	-	-
	E505TX-X	C1 M12 M21, Z	0,10	12	1,0	0,04	0,03	8.0-10.5	0,40	0.85-1.20	-	0,75 (0,5 AWS)	-	-
2209	E2209TO-X	C1 M12 M21, Z	0,04	0.5-2.0	1,0	0,04	0,03	21.0-24.0	7.5-10.0	2.5-4.0	-	0,75 (0,5 AWS)	0,08-0,20	-
2553	E2553TO-X	C1 M12 M21, Z	0,04	0.5-1.5	1,0	0,04	0,03	24.0-27.0	8.5-10.5	2.9-3.9	-	0,75 (0,5 AWS)	0,10-0,25	-
2594		C1 M12 M21, Z	0,04	0.5-2.5	1,0	0,04	0,03	24.0-27.0	8.0-10.5	2.5-4.5	-	0,75 (0,5 AWS)	0,20-0,30	W:1.0
		C1 M12 M21, Z												

a) "-" signs in the Table are used to indicate that these element are not required to be analyzed

b) Single values shown in Table are maximum values.

c) Consumables for which the chemical composition is not listed in the table shall be symbolised similarly and perfixed by letter Z The chemical composition ranges are not specified and therefore two electrodes with same Z classification may not be interchangeable

## GUIDE TO AWS 5.22 : STAINLESS STEEL ELECTRODES FOR FLUX CORED ARC WELDING AND STAINLESS STEEL FLUX CORED RODS FOR GAS TUNGSTEN ARC WELDING

E = Wire electrode  
R = Wire rod

T = (tubular) This designator identifies the electrode as a flux cored electrode

0 = Is for flat and horizontal positions only  
1 = Is for all positions (flat, horizontal, vertical with downward progression and/or vertical with upward progression and overhead)

**E 307 T 1 -1**

1 = CO<sub>2</sub>  
3 = None (self-shielded)  
4 = 75-80% Ar/Rest CO<sub>2</sub>  
5 = 100% Argon  
G = Not Specified

Symbols and all-weld metal chemical composition requirements of non-gas shielded flux cored electrodes

Classification ISO	Classification AWS	Chemical composition % by mass a) b) DE													
		Sh.- gas	C	Mn	Si	Pc	Sc	Cr	Ni	Mo	Nb+Tad	Cu	N	Others	
307	E307T0-3	NO	0,13	3.30-4.75	1,0	0,04	0,03	19.5-22.0	9.0-10.5	0.5-1.5	-	0,75 (0,5)	-	-	
308	E308T0-3	NO	0,08	0.5-2.5	1,0	0,04	0,03	19.5-22.0	9.0-11.0	0,75(0,5)	-	0,75 (0,5)	-	-	
308L	E308LT0-3	NO	0,04(0,03)	0.5-2.5	1,0	0,04	0,03	19.5-22.0	9.0-12.0 (11,0)	0,75(0,5)	-	0,75 (0,5)	-	-	
308H	E308HT0-3	NO	0,04-0,08	0.5-2.5	1,0	0,04	0,03	19.5-22.0	9.0-11.0	0,75(0,5)	-	0,75 (0,5)	-	-	
308Mo	E308MoT0-3	NO	0,08	0.5-2.5	1,0	0,04	0,03	18.0-21.0	9.0-11.0	2.0-3.0	-	0,75 (0,5)	-	-	
308LMo	E308LMoT0-3	NO	0,04(0,03)	0.5-2.5	1,0	0,04	0,03	18.0-21.0	9.0-12.0	2.0-3.0	-	0,75 (0,5)	-	-	
308HMo	E308HMoT0-3	NO	0.07-0.12	1.25-2.25	0.25-0.80	0,04	0,03	19.0-21.5	9.0-10.7	1.8-2.4	-	0,75 (0,5)	-	-	
309	E309T0-3	NO	0,10	0.5-2.5	1,0	0,04	0,03	22.0-25.0	12.0-14.0	0,75(0,5)	-	0,75 (0,5)	-	-	
309L	E309LT0-3	NO	0,04(0,03)	0.5-2.5	1,0	0,04	0,03	22.0-25.0	12.0-14.0	0,75(0,5)	-	0,75 (0,5)	-	-	
309Mo	E309MoT0-3	NO	0,12	0.5-2.5	1,0	0,04	0,03	21.0-25.0	12.0-16.0	2.0-3.0	-	0,75 (0,5)	-	-	
309LMo	E309LMoT0-3	NO	0,04	0.5-2.5	1,0	0,04	0,03	21.0-25.0	12.0-16.0	2.0-3.0	-	0,75 (0,5)	-	-	
309LNb	E309LCbT0-3	NO	0,04(0,03)	0.5-2.5	1,0	0,04	0,03	23.0-25.5	12.0-14.0	0,75(0,5)	0,7 - 1,0	0,75 (0,5)	-	-	
310	E310T0-3	NO	0,20	1.0-2.5	1,0	0,04	0,03	25.0-28.0	20.0-22.5	0,75(0,5)	-	0,75 (0,5)	-	-	
312	E312T0-3	NO	0,15	0.5-2.5	1,0	0,04	0,03	28.0-32.0	8.0-10.5	0,75(0,5)	-	0,75 (0,5)	-	-	
316	E316T0-3	NO	0,08	0.5-2.5	1,0	0,04	0,03	18.0-20.5	11.0-14.0	2.0-3.0	-	0,75 (0,5)	-	-	
316L	E316LT0-3	NO	0,04(0,03)	0.5-2.5	1,0	0,04	0,03	18.0-20.5	11.0-14.0	2.0-3.0	-	0,75 (0,5)	-	-	
	E316LKT0-3	NO	0,04	0.5-2.5	1,0	0,04	0,03	17.0-20.0	11.0-14.0	2.0-3.0	-	0,75 (0,5)	-	-	
316H		NO	0,04-0,08	0.5-2.5	1,0	0,04	0,03	18.0-20.5	11.0-14.0	2.0-3.0	-	0,75 (0,5)	-	-	
316LCu		NO	0,04	0.5-2.5	1,0	0,04	0,03	17.0-20.0	11.0-16.0	1.25-2.75	-	0,75 (0,5)	-	-	
317		NO	0,08	0.5-2.5	1,0	0,04	0,03	13.0-15.0	13.0-15.0	3.0-4.0	-	0,75 (0,5)	-	-	
317L	E317LT0-3	NO	0,04(0,03)	0.5-2.5	1,0	0,04	0,03	18.0-21.0	13.0-15.0	3.0-4.0	-	0,75 (0,5)	-	-	
318		NO	0,08	0.5-2.5	1,0	0,04	0,03	18.0-20.5	11.0-14.0	2.0-3.0	8 x C min 1,0 max	0,75 (0,5)	-	-	
347	E347T0-3	NO	0,08	0.5-2.5	1,0	0,04	0,03	18.0-21.0	9.0-11.0	0,75(0,5)	8 x C min 1,0 max	0,75 (0,5)	-	-	
347L		NO	0,04	0.5-2.5	1,0	0,04	0,03	18.0-21.0	9.0-11.0	0,75	8 x C min 1,0 max	0,75 (0,5)	-	-	
347H		NO	0,04-0,08	0.5-2.5	1,0	0,04	0,03	18.0-21.0	9.0-11.0	0,75	8 x C min 1,0 max	0,75 (0,5)	-	-	
409	E409T0-3	NO	0,10	0,80	1,0	0,04	0,03	10.5-13.5	0,6	0,75(0,5)	-	0,75 (0,5)	-	Ti: 10xC 1,5 max	
409Nb		NO	0,10	1,2	1,0	0,04	0,03	10.5-13.5	0,6	0,75	8 x C min 1,5 max	0,75 (0,5)	-	-	
410	E410T0-3	NO	0,12	1,0	1,0	0,04	0,03	11.5-13.5	0,6	0,75(0,5)	-	0,75 (0,5)	-	-	
410NiMo	E410NiMoT0-3	NO	0,06	1,0	1,0	0,04	0,03	11.5-12.5	4.0-5.0	0.40-0.7	-	0,75 (0,5)	-	-	
	E410NiTiT0-3	NO	0,04	0,7	0,5	0,03	0,03	11.0-12.0 3	3.6-4.5	0,5	-	0,75 (0,5)	-	-	
430	E430T0-3	NO	0,10	1,0	1,0	0,04	0,03	15.0-18.0	0,6	0,75(0,5)	-	0,75 (0,5)	-	-	
430Nb		NO	0,10	1,2	1,0	0,04	0,03	15.0-18.0	0,6	0,75	0.5-1.5	0,75 (0,5)	-	-	
16-8-2		NO	0,10	0.5-2.5	1,0	0,04	0,03	14.5-17.5	7.5-9.5	1.0-2.0	-	0,75 (0,5)	-	Cr+Mo=18,5 max	
2209		NO	0,04	0.5-2.0	1,0	0,04	0,03	21.0-24.0	7.5-10.0	2.5-4.0	-	0,75 (0,5)	0.08-0.20	-	
2553		NO	0,04	0.5-1.5	1,0	0,04	0,03	24.0-27.0	8.5-10.5	2.9-3.9	-	0,75 (0,5)	0.10-0.25	-	
2594		NO	0,04	0.5-2.5	1,0	0,04	0,03	24.0-27.0	8.0-10.5	2.5-4.5	-	0,75 (0,5)	0.20-0.30	W:1.0	
		NO	Any other agreed composition												

a) "-" signs in the Table are used to indicate that these element are not required to be analyzed

b) Single values shown in Table are maximum values.

c) Consumables for which the chemical composition is not listed in the table shall be symbolised similarly and prefixed by letter Z The chemical composition ranges are not specified and therefore two electrodes with same Z classification may not be interchangeable (XX) = AWS Percent

WELDING KNOW-HOW - STANDARD

GUIDE TO AWS 5.22 : STAINLESS STEEL ELECTRODES FOR FLUX CORED ARC WELDING AND STAINLESS STEEL FLUX CORED RODS FOR GAS TUNGSTEN ARC WELDING

E = Wire electrode  
R = Wire rod

T = (tubular) This designator identifies the electrode as a flux cored electrode

0 = Is for flat and horizontal positions only  
1 = Is for all positions (flat, horizontal, vertical with downward progression and/or vertical with upward progression and overhead)

1 = CO<sub>2</sub>  
3 = None (self-shielded)  
4 = 75-80% Ar/Rest CO<sub>2</sub>  
5 = 100% Argon  
G = Not Specified

E 307 T 1 -1

Symbols and all-weld metal chemical composition requirements of cored rods for tungsten arc welding

Classification ISO	Classification AWS	Chemical composition % by mass a) b) DE												
		Sh.- gas	C	Mn	Si	Pc	Sc	Cr	Ni	Mo	Nb+Tad	Cu	N	Others
308L	R308LT1-5	Argon I1,Z	0,03	0,5-2,5	1,2	0,04	0,03	18,0-21,0	9,0-11,0	0,5	-	0,5	-	-
309L	R309LT1-5	Argon I1,Z	0,03	0,5-2,5	1,2	0,04	0,03	22,0-25,0	12,0-14,0	0,5	-	0,5	-	-
316L	R316LT1-5	Argon I1,Z	0,03	0,5-2,5	1,2	0,04	0,03	17,0-20,0	11,0-14,0	2,0-3,0	-	0,5	-	-
347L	R347T1-5	Argon I1,Z	0,08	0,5-2,5	1,2	0,04	0,03	18,0-21,0	9,0-11,0	0,5	8xC 1,0max	0,5	-	-
Z		Argon I1,Z	Any other agreed composition											

a) "-" signs in the Table are used to indicate that these element are not required to be analyzed

b) Single values shown in Table are maximum values.

c) Consumables for which the chemical composition is not listed in the table shall be symbolized similarly and prefixed by letter Z The chemical composition ranges are not specified and therefore two electrodes with same Z classification may not be interchangeable

Classification AWS	Tensile Strength		Elongation	Postweld Heat Treatment
	ksi	MPa	%	
E307TX-X	85	590	30	None
E308TX-X	80	550	35	
E308LTX-X	75	520	35	
E308HTX-X	80	550	35	
E308MoTX-X	80	550	35	
E308LMoTX-X	75	520	35	
E309TX-X	80	550	30	
E309LCbTX-X	75	520	30	
E309LTX-X	75	520	30	
E309MoTX-X	80	550	25	
E309LMoTX-X	75	520	25	
E309LNiMoTX-X	75	520	25	
E310TX-X	80	550	30	
E312TX-X	95	660	22	
E316TX-X	75	520	30	
E316LTX-X	70	485	30	
E317LTX-X	75	520	20	
E347TX-X	75	520	30	
E409TX-X	65	450	15	
E410TX-X	75	520	20	b
E410NiMoTX-X	110	760	15	c
E410NiTiTX-X	110	760	15	c
E430TX-X	65	450	20	d
E502TX-X	60	415	20	e
E505TX-X	60	415	20	e
E308HMoT0-3	80	550	30	None
E316LKT0-3	70	485	30	
E2209TX-X	100	690	20	None
E2553TX-X	110	760	15	
	Not Specified			
R308LT1-5	75	520	35	None
R309LT1-5	75	520	30	
R316LT1-5	70	485	30	
R347T1-5	75	520	30	

NOTE:

- a) In this table, the "X" following the "T" refers to the position of welding (1 for all-position or 0 for flat or horizontal operation) and the "X" following the dash refers to the shielding medium (-1, -3 or -4) as shown in the AWS Classification.
- b) The weld test assembly (or the blank from it, from which the tensile test specimen is to be machined) shall be heated to a temperature between 1350 and 1400°F (732 and 760°C), held for 1 hour, then furnace cooled to 600°F (316°C) at a rate not to exceed 100°F (55°C) per hour, then cooled in air to room temperature.
- c) The weld test assembly (or the blank from it, from which the tensile test specimen is to be machined) shall be heated to a temperature between 1100 and 1150°F (593 and 621°C), held for 1 hour, then cooled in air to room temperature.
- d) The weld test assembly (or the blank from it, from which the tensile test specimen is to be machined) shall be heated to a temperature between 1400 and 1450°F (760 and 788°C), held for 4 hours, then furnace cooled to 1100°F (593°C) at a rate not to exceed 100°F (55°C) per hour, then cooled in air to room temperature.
- e) The weld test assembly (or blank from it, from which the tensile test specimen is to be machined) shall be heated to a temperature between 1550 and 1600°F (840 and 870°C) held for 2 hours, then furnace cooled to 1100°F (593°C) at a rate not to exceed 100°F (55°C) per hour, then cooled in air to room temperature.

## GUIDE TO AWS 5.22 : STAINLESS STEEL ELECTRODES FOR FLUX CORED ARC WELDING AND STAINLESS STEEL FLUX CORED RODS FOR GAS TUNGSTEN ARC WELDING

## Supplementary information

ISO Classification A	ISO Classification B	AWS Classification	Proof strength Rp02		Tensile Strength, Rm		Elongation	Postweld Heat Treatment	NOTE:
			ksi	MPa	ksi	MPa	Iso A/B (AWS) %		
	307	E307TX-X			75	590	25 (30)	None	a) In this table, the "X" following the "T" refers to the position of welding (1 for all-position or 0 for flat or horizontal operation) and the "X" following the dash refers to the shielding medium (-1, -3 or -4) as shown in the AWS Classification.
	308	E308TX-X			80	550	25 (35)		
19 9 L	308L	E308LTX-X	46	320	75	(Iso A 510) 520	30 / 25 (35)	None	b) The weld test assembly (or the blank from it, from which the tensile test specimen is to be machined) shall be heated to a temperature between 1350 and 1400°F (732 and 760°C), held for 1 hour, then furnace cooled to 600°F (316°C) at a rate not to exceed 100°F (55°C) per hour, then cooled in air to room temperature.
19 9 H	308H	E308HTX-X	51	350	75	550	30 / 25 (35)		
20 10 3	308Mo	E308MoTX-X	58	400	80	(Iso A 620) 550	20 / 25 (35)	None	c) The weld test assembly (or the blank from it, from which the tensile test specimen is to be machined) shall be heated to a temperature between 1100 and 1150°F (593 and 621°C), held for 1 hour, then cooled in air to room temperature.
	308LMo	E308LMoTX-X			75	520	25 (35)		
	308HMo				75	550	25	None	d) The weld test assembly (or the blank from it, from which the tensile test specimen is to be machined) shall be heated to a temperature between 1400 and 1450°F (760 and 788°C), held for 4 hours, then furnace cooled to 1100°F (593°C) at a rate not to exceed 100°F (55°C) per hour, then cooled in air to room temperature.
21 10 N			51	350	75	550	25		
23 7 N L			65	450	83	570	20	None	e) The weld test assembly (or blank from it, from which the tensile test specimen is to be machined) shall be heated to a temperature between 1550 and 1600°F (840 and 870°C) held for 2 hours, then furnace cooled to 1100°F (593°C) at a rate not to exceed 100°F (55°C) per hour, then cooled in air to room temperature.
	309	E309TX-X			80	550	25 (30)		
23 12 Nb	309Nb		51	350	75	550	25	None	
	309LNb	E309LCbTX-X			75	520	25 (30)		
23 12 L	309L	E309LTX-X	46	320	70	(Iso A 510) 520	25 (30)	None	
22 12 H	309H		51	350	80	550	25		
	309Mo	E309MoTX-X			80	550	15 (25)	None	
23 12 2 L	309LMo	E309LMoTX-X	51	350	75	(Iso A 550) 520	25 (30)		
	309LNiMo	E309LNiMoTX-X			75	520	25	None	
25 20	310	E310TX-X	51	350	80	550	25 (30)		
25 4			65	450	94	650	15	None	
29 9	312	E312TX-X	65	450	95	(Iso A 650) 660	15 (22)		
	316	E316TX-X			75	520	25 (30)	None	
19 12 3 L	316L	E316LTX-X	46	320	70	(Iso A 510) 485	25 (30)		
	316H				75	520	25	None	
	316LCu				70	485	25		
19 13 4 N L			51	350	75	550	25	None	
	317				80	550	20		
	317L	E317LTX-X			75	520	20	None	
19 12 3 Nb	318		51	350	75	(Iso A 550) 520	25 / 20		
19 9 Nb	347	E347TX-X	51	350	75	(Iso A 550) 520	25 (30)	None	
	347L				75	520	25		
19 9 Nb	347 H				80	550	25	None	
13 Ti	409	E409TX-X	36	250	65	450	15		
	409Nb				65	450	15	None	
13	410	E410TX-X	36	250	75	(Iso A 450) 520	20		
13 4	410NiMo	E410NiMoTX-X	73	500	110	(Iso A 750) 760	10 (15)	None	
		E410NiTiTX-X			110	760	15		
17	430	E430TX-X	44	300	65	450	15 (20)	None	
	430Nb				65	450	13		
		E502TX-X			60	415	20	None	
		E505TX-X			60	415	20		
		E308HMoT0-3			80	550	30	None	
		E316LKT0-3			70	485	30		
16-8-2	16-8-2		46	320	75	(IsoA 510) 520	25	None	
18 16 5 N L			44	300	70	480	25		
18 8 Mn			51	350	73	500	25	None	
18 9 Mn Mo			51	350	73	500	25		
22 9 3 N L	2209	E2209TX-X	65	45	100	(IsoA 550) 690	20 / 15 (20)	None	
20 25 5 Cu N L			46	320	74	510	25		
25 9 4 Cu N L	2553	E2553TX-X			110	760	13 (15)	None	
25 9 4 N L	2594		80	550	110	(Iso A 620) 760	18 / 13		
25 9 4 Cu N L	Z	EXXXTX-G	Not Specified					None	
		R308LT1-5			75	520	35		
		R309LT1-5			75	520	30		
		R316LT1-5			70	485	30		
		R347T1-5			75	520	30	None	

GUIDE TO AWS 5.23 : LOW-ALLOY STEEL ELECTRODES AND FLUXES FOR SUBMERGED ARC WELDING WELDING

Multiple Pass Classification					
	Tensile strength		Min. yield strength		Elongation
	ksi	MPa	ksi	MPa	
	70-95	483-655	58	400	22
8	80-100	552-698	68	489	20
9	90-110	621-758	78	538	17
10	100-120	689-827	887	607	16
11	110-130	758-896	98	676	15
12	120-140	827-965	108	745	14
13	130-150	896-1034	118	814	14

Multiple Pass Classification					
	Tensile strength		Min. yield strength		Elongation
	ksi	MPa	ksi	MPa	
6	60	414	50		22
7	70	483	60	400	22
8	80	552	70	489	20
9	90	621	80	538	17
10	100	689	90	607	16
11	110	758	100	676	15
12	120	827	110	745	14
13	130	896	120	814	14

	Temperature		Charpy-V min.	
	°F	°C	ft-lb	J
0	0	-18	20	27
2	-20	-29	20	27
4	-40	-40	20	27
5	-50	-46	20	27
6	-60	-51	20	27
8	-80	-62	20	27
10	-100	-73	20	27
15	-150	-101	20	27
Z	No requirements			

F = Flux for Submerged Arc welding

A = As welded  
P = Post weld heat treated (PWHT) 620°C / 1h

**F 9 P 0 -EB3 -B3 HX**

Hydrogen content	
Symbol	ml/100g weld metal
H2	2
H4	4
H8	8
H16	16

CHEMICAL COMPOSITION REQUIREMENTS FOR WELD METAL a Part1

Weld Metal Designation b) c)	Chemical composition % f) g)									
	C	Mn	Si	S	P	Cr	Ni	Mo	Cu	Other
A1	0,12	1.00	0,80	0.030	0.030	-	-	0.40-0.65	0,35	-
A2	0,12	1.40	0,80	0.030	0.030	-	-	0.40-0.65	0,35	-
A3	0,15	2.10	0,80	0.030	0.030	-	-	0.40-0.65	0,35	-
A4	0,15	1.60	0,80	0.030	0.030	-	-	0.40-0.65	0,35	-
B1	0,12	1.60	0,80	0.030	0.030	0.40-0.65	-	0.40-0.65	0,35	-
B2h	0.05-0.15	1.20	0,80	0.030	0.030	1.00-1.50	-	0.40-0.65	0,35	V: 0.30
B2H	0.10-0.25	1.20	0,80	0.020	0.020	1.00-1.50	-	0.40-0.65	0,35	-
B3h	0.05-0.15	1.20	0,80	0.030	0.030	2.00-2.50	-	0.90-1.20	0,35	-
B4	0,12	1.20	0,80	0.030	0.030	1.75-2.25	-	0.40-0.65	0,35	-
B5	0,18	1.20	0,80	0.030	0.030	0.40-0.65	-	0.90-1.20	0,35	-
B6	0,12	1.20	0,80	0.030	0.030	4.50-6.00	-	0.40-0.65	0,35	-
B6H	0.10-0.25	1.20	0,80	0.030	0.030	4.50-6.00	-	0.40-0.65	0,35	-
B8	0,12	1.20	0,80	0.030	0.030	8.00-10.0	-	0.80-1.20	0,35	-
B9	0,08-0,13	1.20	0,80	0.010	0.010	8.00-10.5	0.80 i	0.80-1.20	0,25	Nb (Cb): 0.02-0.10 N: 0.02-0.07 V: 0.15-0.25 Al: 0.04
Ni1	0,12	1.60	0,80	0.025	0.030	0,15	0.75-1.10	0,35	0,35	Ti + V + Zr: 0.05
Ni2	0,12	1.60	0,80	0.025	0.030	-	2.00-2.90	-	0,35	-
Ni3	0,12	1.60	0,80	0.025	0.030	0,15	2.80-3.80	-	0,35	-
Ni4	0,14	1.60	0,80	0.025	0.030	-	1.40-2.10	0.10-0.35	0,35	-
Ni5	0,12	1.60	0,80	0.025	0.030	-	0.70-1.10	0.10-0.35	0,35	-
F1	0,12	0.70-1.50	0,80	0.030	0.030	0,15	0.90-1.70	0.55	0,35	-
F2	0,17	1.25-2.25	0,80	0.030	0.030	-	0.40-0.80	0.40-0.65	0,35	-
F3	0,17	1.25-2.25	0,80	0.030	0.030	-	0.70-1.10	0.40-0.65	0,35	-
F4	0,17	1.60	0,80	0.035	0.030	0,60	0.40-0.80	0,25	0,35	Ti + V + Zr: 0.03
F5	0,17	1.20-1.80	0,80	0.020	0.020	0,65	2.00-2.80	0.30-0.80	0,50	-
F6	0,14	0.80-1.85	0,80	0.020	0.030	0,65	1.50-2.25	0,60	0,40	-
M1	0,10	0.60-1.60	0,80	0.030	0.030	0,15	1.25-2.00	0,35	0,30	Ti + V + Zr: 0.03
M2	0,10	0.90-1.80	0,80	0.020	0.020	0,35	1.40-2.10	0.25-0.65	0,30	Ti + V + Zr: 0.03
M3	0,10	0.90-1.80	0,80	0.020	0.020	0,65	1.80-2.60	0.20-0.70	0,30	Ti + V + Zr: 0.03
M4	0,10	1.30-2.25	0,80	0.020	0.020	0,80	2.00-2.80	0.30-0.80	0,30	Ti + V + Zr: 0.03
M5	0,12	1.60-2.50	0,80	0.015	0.015	0,40	1.40-2.10	0.20-0.50	0,30	Ti: 0.03 V: 0.02 Zr: 0.02
M6	0,12	1.60-2.50	0,50	0.015	0.015	0,40	1.40-2.10	0.70-1.00	0,30	Ti: 0.03 V: 0.02 Zr: 0.02
W	0,12	0.50-1.60	0,80	0.030	0.035	0,45-0,70	0.40-0.80	-	0.30-0.75	-
G	As agreed between supplier and purchaser									

- a) These requirements are applicable to both flux-solid electrode and flux-composite electrode combinations.
- b) The electrode designation for composite electrodes is obtained by placing an "EC" before the appropriate weld metal designation.
- c) The letter "N" when added as a suffix is an optional supplemental designator indicating that the limits as follows: P≤0.012%, V≤0.05%, and Cu≤0.08%. Additional requirements are given in
- d) Refer to ASTM DS-56/SAE HS-1086, Metals & Alloys in the Unified Numbering System.
- e) The weld metal shall be analyzed for the specific elements for which values are shown in this table. If the presence of other elements is indicated in the course of this work, the amount of those elements shall be determined to ensure that their total (excluding iron) does not exceed 0.50%.
- f) Single values are maximum.
- g) As a substitute for the weld pad in Fig. 3, the sample for chemical analysis may be taken from the reduced section of the fractured tension test specimen (see 10.2) or from a corresponding location (or any location above it) in the weld metal in the groove weld in Fig. 4. In case of dispute, the weld pad shall be the referee method.
- h) The letter "R" when added as a suffix is an optional supplemental designator indicating that the limits on sulfur, phosphorous, copper, arsenic, tin and antimony are as follows: S≤0.010% P≤0.010% , Cu≤0.15% , As ≤ 0.005% , Sn ≤ 0.005% , and Sb≤0.005% . These reduced residual limits are necessary to meet the "X" factor requirements for step cooling applications.
- i) Mn + Ni ≤1.50% maximum (see A7.2.3.1 in Annex A).
- j) Manganese in the Ni1 and Ni2 designated weld metals may be 1.80% maximum when the carbon is restricted to 0.10% maximum.

7

## GUIDE TO AWS 5.23 : LOW-ALLOY STEEL ELECTRODES AND FLUXES FOR SUBMERGED ARC WELDING

## CHEMICAL COMPOSITION REQUIREMENTS FOR SOLID Part 2 ELECTRODES

F	9	P	0	-EB3	-B3	HX
---	---	---	---	------	-----	----

Electrode Designation c)	Chemical composition % f g)											others		
	C	Mn	Si	S	P	Cr	Ni	Mo	Cu	V				
EL8	0.10	0.25-0.60	0.07	0,030	0,030	-	-	-	-	-	-	-		
EL8K	0.10	0.25-0.60	0.10-0.25	0,030	0,030	-	-	-	-	-	-	-		
EL12	0.04-0.14	0.25-0.60	0.10	0,030	0,030	-	-	-	-	-	-	-		
EM11K	0.07-0.15	1.00-1.50	0.65-0.85	0,030	0,025	-	-	-	-	-	-	-		
EM12	0.06-0.15	0.80-1.25	0,10	0,030	0,030	-	-	-	-	-	-	-		
EM12K	0.05-0.15	0.80-1.25	0.10-0.35	0,030	0,030	-	-	-	-	-	-	-		
EM13K	0.06-0.16	0.90-1.40	0.35-0.75	0,030	0,030	-	-	-	-	-	-	-		
EM14K	0.06-0.19	0.90-1.40	0.35-0.75	0,025	0,025	-	-	-	-	-	-	-	Ti: 0.03-0.17	
EM15K	0.10-0.20	0.80-1.25	0.10-0.35	0,030	0,030	-	-	-	-	-	-	-		
EH10K	0.07-0.15	1.30-1.70	0.05-0.25	0,025	0,025	-	-	-	-	-	-	-		
EH11K	0.06-0.15	1.40-1.85	0.80-1.15	0,030	0,030	-	-	-	-	-	-	-		
EH12K	0.06-0.15	1.50-2.00	0.20-0.65	0,025	0,025	-	-	-	-	-	-	-		
EH114	0.10-0.20	1.70-2.20	0.10	0,030	0,030	-	-	-	-	-	-	-		
EA1	0.05-0.15	0.65-1.00	0,20	0,025	0,025	-	-	0.45-0.65	-	-	-	-		
EA1TiB	0.05-0.15	0.65-1.00	0,20	0,025	0,025	-	-	0.45-0.65	-	-	-	-	Ti: 0.05-0.30 B: 0.005-0.030	
EA2TiB	0.05-0.17	0.95-1.35	0,20	0,025	0,025	-	-	0.45-0.65	-	-	-	-	Ti: 0.05-0.30 B: 0.005-0.030	
EA2	0.05-0.17	0.95-1.35	0,20	0,025	0,025	-	-	0.45-0.65	0,35	-	-	-		
EA3	0.05-0.17	1.65-2.20	0,20	0,025	0,025	-	-	0.45-0.65	0,35	-	-	-		
EA3K	0.05-0.15	1.60-2.10	0.50-0.80	0,025	0,025	-	-	0.40-0.60	0,35	-	-	-		
EA4	0.05-0.15	1.20-1.70	0,20	0,025	0,025	-	-	0.45-0.65	0,35	-	-	-		
EB1	0.10	0.40-0.80	0.05-0.30	0,025	0,025	0.40-0.75	-	0.45-0.65	0,35	-	-	-		
EB2 <sup>a</sup>	0.07-0.15	0.45-1.00	0.05-0.30	0,025	0,025	1.00-1.75	-	0.45-0.65	0,35	-	-	-		
EB2H	0.28-0.33	0.45-0.65	0.55-0.75	0,015	0,015	1.00-1.50	-	0.40-0.65	0,30	0.20-0.30	-	-		
EB3 <sup>b</sup>	0.05-0.15	0.40-0.80	0.05-0.30	0,025	0,025	2.25-3.00	-	0.90-1.10	0,35	-	-	-		
EB5	0.15-0.23	0.40-0.70	0.40-0.60	0,025	0,025	0.45-0.65	-	0.90-1.20	0,30	-	-	-		
EB6	0.10	0.35-0.70	0.05-0.50	0,025	0,025	4.50-6.50	-	0.45-0.70	0,35	-	-	-		
EB6H	0.25-0.40	0.75-1.00	0.25-0.50	0,025	0,025	4.80-6.00	-	0.45-0.65	0,35	-	-	-		
EB8	0.10	0.30-0.65	0.05-0.50	0,025	0,025	8.00-10.50	-	0.80-1.20	0,35	-	-	-		
EB23	0.05-0.12	1,10	0,50	0,015	0,015	1,9-3,0	0,5	0,5	0,10	0,15-0,30	-	-	W: 1.50-2.00 Nb: 0.02-0.10 B: 0.006 Al: 0.04 N: 0.05	
EB24	0.04-0.12	1,10	0,50	0,015	0,020	1,9-3,0	0,3	0,8-1,20	0,10	0,15-0,30	-	-	Nb: 0.02-0.10 Ti: 0.10 B: 0.006 Al: 0.04 N: 0.07	
EB91	0.07-0.13	1,25	0,50	0,010	0,010	8.50-10.50	1.00h	0.85-1.15	0,10	-	-	-	Nb (Cb): 0.02-0.10 N: 0.03-0.07 Al: 0.04	
EF1	0.07-0.15	0.90-1.70	0.15-0.35	0,025	0,025	-	-	0.95-1.60	0.25-0.55	0,35	-	-		
EF2	0.10-0.18	1.70-2.40	0,20	0,025	0,025	-	-	0.40-0.80	0.40-0.65	0,35	-	-		
EF3	0.10-0.18	1.50-2.40	0,30	0,025	0,025	-	-	0.70-1.10	0.40-0.65	0,35	-	-		
EF4	0.16-0.23	0.60-0.90	0.15-0.35	0,030	0,025	0.40-0.60	0.40-0.80	0.15-0.30	0,35	-	-	-		
EF5	0.10-0.17	1.70-2.20	0,20	0,015	0,010	0.25-0.50	2.30-2.80	0.45-0.65	0,35	-	-	-		
EF6	0.07-0.15	1.45-1.90	0.10-0.30	0,015	0,015	0.20-0.55	1.75-2.25	0.40-0.65	0,35	-	-	-		
EM2 <sup>j</sup>	0.10	1.25-1.80	0.20-0.60	0,015	0,010	0.30	1.40-2.10	0.25-0.55	0,35	-	-	-	Ti: 0.10 Zr: 0.10 Al: 0.10	
EM3 <sup>j</sup>	0.10	1.40-1.80	0.20-0.60	0,015	0,010	0.55	1.90-2.60	0.25-0.65	0,35	-	-	-	Ti: 0.10 Zr: 0.10 Al: 0.10	
EM4 <sup>j</sup>	0.10	1.40-1.80	0.20-0.60	0,015	0,010	0.60	2.00-2.80	0.30-0.65	0,35	-	-	-	Ti: 0.10 Zr: 0.10 Al: 0.10	
ENi1	0.12	0.75-1.25	0.05-0.30	0,020	0,020	0.15	0.75-1.25	0.30	0,35	-	-	-		
ENi1K	0.12	0.80-1.40	0.40-0.80	0,020	0,020	-	0.75-1.25	-	0,35	-	-	-		
ENi2	0.12	0.75-1.25	0.05-0.30	0,020	0,020	-	2.10-2.90	-	0,35	-	-	-		
ENi3	0.13	0.60-1.20	0.05-0.30	0,020	0,020	0.15	3.10-3.80	-	0,35	-	-	-		
ENi4	0.12-0.19	0.60-1.00	0.10-0.30	0,020	0,015	-	1.60-2.10	0.10-0.30	0,35	-	-	-		
ENi5	0.12	1.20-1.60	0.05-0.30	0,020	0,020	-	0.75-1.25	0.10-0.30	0,35	-	-	-		
ENi6	0.07-0.15	1.20-1.60	0.05-0.30	0,020	0,020	-	0.75-1.25	0.10-0.30	0,35	-	-	-		
EW	0,12			0,030	0,025	0.50-0.80	0.40-0.80	-	0,35	-	-	-		
EG														Not specified as agreed between supplier and buyer

- a) The electrode shall be analyzed for the specific elements for which values are shown in this Table. If the presence of other elements is indicated in the course of this work, the amount of those elements shall be determined to ensure that their total (excluding iron) does not exceed 0.50%.
- b) Single values are maximum.
- c) The letter "N", when added as a suffix to the electrode classification, is an optional supplemental designator indicating that the limits on phosphorous, vanadium, and copper are as follows: P≤0.012%, V≤0.05%, Cu ≤0.08%
- d) Refer to ASTM DS-56/SAE HS-1086, Metals & Alloys in the Unified Numbering System.
- e) The copper limit includes any copper coating that may be applied to the electrode.
- f) This electrode is also classified under AWS A5.17/A5.17M, Specification for Carbon Steel Electrodes and Fluxes for Submerged Arc Welding. It is included in this specification because it can be used with an alloy flux to deposit some of the weld metals designated in Table 3. In addition, this carbon steel electrode can be used for the two-run classification of flux-electrode combinations according to the provisions of this specification.
- g) The letter "R" when added as a suffix is an optional supplemental designator indicating that the limits on sulfur, phosphorous, copper, arsenic, tin, and antimony are as follows: S≤0.010%, P≤0.010%, Cu≤0.15%, As≤0.005%, Sn≤0.005%, and Sb≤0.005%. These reduced residual limits are necessary to meet "X" factor requirements for step cooling applications.
- h) See A7.2.3.1 in Annex A for a discussion of the B9 alloy and recommendations regarding the Mn + Ni level achieved in the weld deposit. See also note i of Table 3 for limits on the Mn + Ni content of the B9 weld deposit.
- i) The composition ranges of classifications with the "EM" prefix are intended to conform to the ranges of similar electrodes in the military specifications.



## GUIDE TO EN AWS 5.23: LOW-ALLOY STEEL ELECTRODES AND FLUXES FOR SUBMERGED ARC WELDING

Supplementary Info:

COMPARISON OF SOLID ELECTRODE DESIGNATIONS a)

AWS A5.23/A5.23M Classification	ISO 14171 b Designation		ISO 24598 c Designation		ISO 26304 d Designation		<b>NOTES:</b>
	ISO 14171-A	ISO 14171-B	ISO 24598-A	ISO 24598-B	ISO 26304-A	ISO 26304-B	
EL8e	S1	(SU11)	-	-	-	-	<p>a. The requirements for the equivalent classifications shown are not necessarily identical in every respect.</p> <p>b. ISO 14171, Welding consumables - Wire electrodes and wire-flux combinations for submerged arc welding of non alloy and fine grain steels - Classification, is a cohabitation document providing for classification utilizing a system based upon the yield strength and the average impact energy for all-weld metal of 47 J (ISO 14171-A), or utilizing a system based upon the tensile strength and the average impact energy for all-weld metal of 27 J (ISO 14171-B).</p> <p>c. ISO 24598 Welding consumables - Solid wire electrodes, tubular cored electrodes, and electrode-flux combinations for submerged arc welding of creep-resisting steels - Classification, is a cohabitation document. The classification according to system A is mainly based on EN 12070. The classification according to system B is mainly based upon standards used around the Pacific Rim. This ISO document is still under review and has not yet been released for publication.</p> <p>d. ISO 26304, Welding consumables 5 Solid wire electrodes, tubular cored electrodes and electrode/flux combinations for submerged arc welding of high strength steels - Classification, is a cohabitation document. The classification according to system A is mainly based on EN 14295. The classification according to system B is mainly based upon standards used around the Pacific Rim. This ISO document is still under review and has not yet been released for publication.</p> <p>e. These solid wire electrode classifications also appear in AWS A5.17/A5.17M.</p>
EL8Ke	S1Si1	SU12	-	-	-	-	
EL12e	S1	SU11	-	-	-	-	
EM11Ke	-	SU25	-	-	-	-	
EM12e	S2	SU22	-	-	-	-	
EM12Ke	S2Si	SU21	-	-	-	-	
EM13K e	S2Si2	SU25	-	-	-	-	
EM14Ke	-	SU24	-	-	-	-	
EM15K e	S2Si	(SU21)	-	-	-	-	
EH10K e	S3Si	SU32	-	-	-	-	
EH11K e	-	SU31	-	-	-	-	
EH12K e	S4Si	SU42	-	-	-	-	
EH114e	-	SU41	-	-	-	-	
EA1	-	SU1M3	(SMo)	SU1M3	-	-	
EA1TiB	-	-	-	-	-	-	
EA2	S2Mo	SU2M3	SMo	SU2M3	-	-	
EA3	S4Mo	SU4M3	-	SU4M3	-	-	
EA3K	-	SU4M31	-	SU4M32	-	-	
EA4	S3Mo	SU3M3	SMnMo	SU3M3	-	-	
EB1	-	-	-	SUCM	-	-	
EB2g	-	-	SCrMo1	SU1CM	-	-	
EB2H	-	-	-	Su1CMVH	-	-	
EB3g	-	-	SCrMo2	SU2C1M	-	-	
EB5	-	-	-	SUC1MH	-	-	
EB6	-	-	SCrMo5	SU5CM	-	-	
EB6H	-	-	-	SU5CMH	-	-	
EB8	-	-	SCrMo9	SU9C1M	-	-	
EB9	-	-	-	SU9C1MV	-	-	
ENi1	S2Ni1	SUN2	-	-	-	-	
ENi1K	-	SUN21	-	-	-	-	
ENi2	-	SUN5	-	-	-	-	
ENi3	S2Ni3	SUN7	-	-	-	-	
ENi4	-	SUN4M1	-	-	-	SUN4M1	
ENi5	-	SUN2M1	-	-	-	SUN2M1	
EF1					S2Ni1Mo	SUN2M2	
EF2						SUN1M3	
EF3						SUN2M33	
EF4						SUN1C1M1	
EF5						SUN5CM3	
EF6						SUN4C1M3	
EM2i						SUN3M2	
EM3i						SUN4C1M2	
EM4i						SUN5C1M3	
EW	SUNCC1						



## GUIDE TO AWS 5.24: ZIRCONIUM AND ZIRCONIUM-ALLOY WELDING ELECTRODES AND RODS

E = Wire electrode  
R = Wire rod

ER Zr2

Classification AWS	Chemical composition % by mass (1)									
	UNS Number	Zirconium + Hafnium	Hafnium	Iron + Chro- mium	Tin	Oxygen(3)	Hydrogen(3)	Nitrogen(3)	Carbon(3)	Niobium (Columbium)
ERZr2	R60702	99.0 min	4,5	0.20	-	0,11 - 0,15	0.005	0.015	0.03	-
ERZr3	R60704	97.5 min	4,5	0.20 - 0,40	1,00 - 2,00	0,11 - 0,16	0.005	0.015	0.03	-
ERZr4	R60705	95.5 min	4,5	0.20	-	0,11 - 0,16	0.005	0.015	0.03	2,0 - 3,0

**NOTES:**  
 (1) Single values are maximum, except as noted.  
 (2) SAE HS-1086 Metals and Alloys in the Unified Numbering System. Document may be obtained from SAE International, 400 Commonwealth Drive, Warrendale, PA 15096-0001.  
 (3) Analysis of the interstitial elements C, O, H and N shall be conducted on samples of filler metal taken after the filler metal has been reduced to its final diameter and all processing operations have been completed. Analysis of the other elements may be conducted on these same samples or it may have been conducted on samples taken from the ingot or the rod stock from which the filler metal is made. In case of dispute, samples from the finished filler metal shall be the referee method.

**The ERZr2** classification is a "commercially pure" zirconium. It produces weld metal having good strength and ductility. The tensile strength should be at least 55 ksi [380 MPa]. These electrodes and rods are intended to be used for welding the UNS R60702 zirconium alloy.

**The ERZr3** classification contains tin as an alloying element. Tin increases the strength of the weld metal, yet allows it to retain good ductility. The strength should be at least 60 ksi [410 MPa]. These electrodes and rods are intended only for welding UNS R60704 zirconium alloy. Weld metal from ERZr3 filler metal may not resist corrosion as well as that from ERZr2 filler metal.

**The ERZr4** classification contains niobium (columbium) as an alloying element. It produces weld metal of good ductility with a tensile strength of at least 80 ksi [550 MPa]. These electrodes and rods are used only to weld UNS R60705 zirconium alloy. Weld metal from ERZr4 filler metal may not resist corrosion as well as that from ERZr2 filler metal. All welds utilizing ERZr4 filler metal should be post weld heat treated to reduce the susceptibility for delayed hydride cracking.

GUIDE TO AWS 5.25: CARBON AND LOW-ALLOY STEEL ELECTRODES AND FLUXES FOR ELECTROSLAG WELDING

Classification	Classification Metric	Temperature		Min. yield strength		Elongation %
		ksi	MPa	ksi	MPa	
FES6Z-XXX	FES43Z-XXX	60 - 80	430 - 450	38	250	24
FES60-XXX	FES430-XXX					
FES62-XXX	FES432-XXX					
FES7Z-XXX	FES48Z-XXX	70 - 90	480 - 650	50	350	22
FES70-XXX	FES480-XXX					
FES72-XXX	FES482-XXX					
FES8Z-XXX	FES55Z-XXX	80 - 100	550 - 700	60	410	20
FES80-XXX	FES550-XXX					
FES82-XXX	FES552-XXX					

Classification	Classification Metric	Temperature		Charpy-V min.	
		°F	°C	ft-lb	J
FES6Z-XXX	FES43Z-XXX	Not specified			
FES7Z-XXX	FES48Z-XXX				
FES8Z-XXX	FES55Z-XXX				
5FES60-XXX	FES432-XXX	0	-20	15	20
6FES70-XXX	FES482-XXX	0	-20	15	20
8FES80-XXX	FES552-XXX	0	-20	15	20
FES62-XXX	FES433-XXX	-20	-30	15	20
FES72-XXX	FES483-XXX	-20	-30	15	20
FES82-XXX	FES553-XXX	-20	-30	15	20

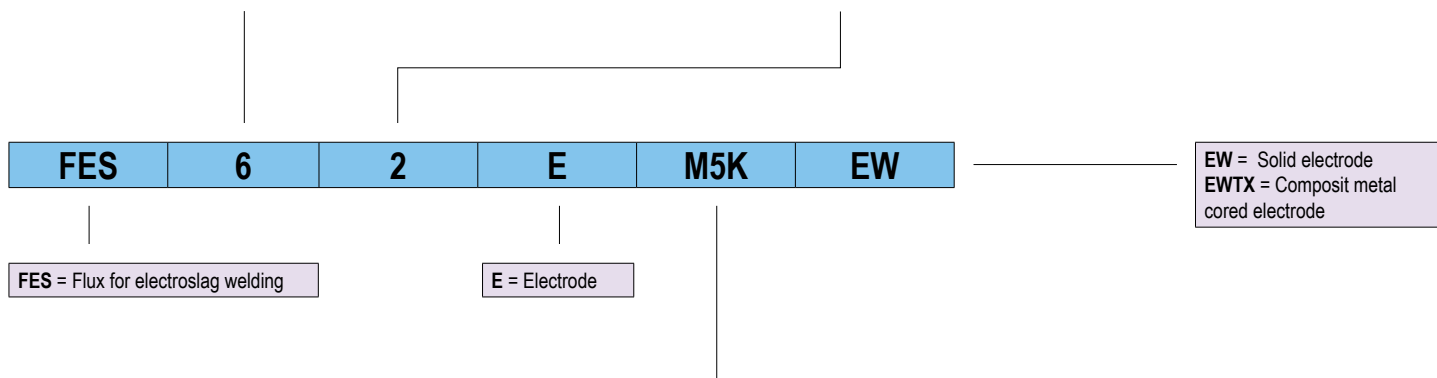

CHEMICAL COMPOSITION REQUIREMENTS FOR SOLID ELECTRODES													
AWS Classification c)	Weight Percent, a) b)												
	C	Mn	P	S	Si	Ni	Cr	Mo	Cu	Ti	Zr	Al	Other
<b>Medium-Manganese Classes</b>													
EM5K-EW	0.07	0.90-1.40	0,025	0,030	0.40-0.70	-	-	-	0.35	0.05-0.15	0.02-0.12	0.05-0.15	0.50
EM12-EW	0.06-0.15	0.80-1.25	0,030	0,030	0.10	-	-	-	0.35	-	-	-	0.50
EM12K-EW	0.06-0.15	0.80-1.25	0,030	0,030	0.10-0.35	-	-	-	0.35	-	-	-	0.50
EM13K-EW	0.06-0.16	0.90-1.40	0,030	0,030	0.35-0.75	-	-	-	0.35	-	-	-	0.50
EM15K-EW	0.10-0.20	0.80-1.25	0,030	0,030	0.10-0.35	-	-	-	0.35	-	-	-	0.50
<b>High-Manganese Classes</b>													
EH14-EW	0.10-0.20	1.70-2.20	0,030	0,030	0,10	-	-	-	0.35	-	-	-	0.50
<b>Special Classes</b>													
EWS-EW	0.07-0.12	0.35-0.65	0,030	0,030	0.22-0.37	0.40-0.75	0.50-0.80	-	0.25-0.55	-	-	-	0.50
EA3K-EWf	0.07-0.12	1.60-2.10	0,025	0,025	0.50-0.80	0,15	-	0.40-0.60	0.35	-	-	-	0.50
EH10K-EW	0.07-0.14	1.40-2.00	0,025	0,030	0.15-0.30	-	-	-	-	-	-	-	0.50
EH11K-EW	0.06-0.15	1.40-1.85	0,025	0,030	0.80-1.15	-	-	-	0.35	-	-	-	0.50
ES-G-EW	As agreed between supplier and purchaser												

**NOTES:**

- The electrode shall be analyzed for the specific elements for which values are shown in this table. If the presence of other elements is indicated, in the course of this work, the amount of those elements shall be determined to ensure that their total (excluding iron) does not exceed the limit specified for "Other Elements, Total" in the last column of the table.
- Single values are maximums.
- Chemical composition requirements may be similar to those in other AWS specifications; see Table A1 in the Annex.
- The copper limit includes copper that may be applied as a coating on the electrode.
- Formerly classified EH10Mo-EW in ANSI/AWS A5.25-91.
- Composition shall be reported; the requirements are those agreed to by the purchaser and the supplier.

7

CHEMICAL COMPOSITION REQUIREMENTS FOR WELD METAL FROM COMPOSITE METAL CORED ELECTRODES											
AWS Classification c)	Weight Percent, a) b)										
	C	Mn	P	S	Si	Ni	Cr	Mo	Cu	V	Andere
EWT1	0.13	2.00	0,030	0,030	0.60	-	-	-	-	-	0.50
EWT2	0.12	0.50-1.60	0,030	0,040	0.25-0.80	0.40-0.80	0.40-0.70	-	0.25-0.75	-	0.50
EWT3	0.12	1.00-2.00	0,020	0,030	0.15-0.50	1.50-2.50	0,20	0.40-0.65	-	0,05	0.50
EWTG	As agreed between supplier and purchaser										

**NOTES:**

- The flux used, when classifying composite electrodes shall be one with which the electrode is classified for mechanical properties (see Tables 3 or 3M and 4 or 4M).
- The weld metal shall be analyzed for the specific elements for which values are shown in this table. If the presence of other elements is indicated, in the course of this work, the amount of those elements shall be determined to ensure that their total (excluding iron) does not exceed the limit specified for "Other Elements, Total" in the last column of the table.
- Single values are maximums.

## GUIDE TO AWS 5.26 : CARBON AND LOW-ALLOY STEEL ELECTRODES FOR ELECTROGAS WELDING

Classification	Classification Metric	Tensile strength		Min. yield strength		Elongation
		ksi	MPa	ksi	MPa	
EG6ZX-X	EG43ZX-X	60 - 80	430 - 450	38	250	24
EG60X-X	EG432X-X					
EG62X-X	EG433X-X					
EG7ZX-X	EG48ZX-X	70 - 95	480 - 650	50	350	22
EG70X-X	EG482X-X					
EG72X-X	EG483X-X					
EG8ZX-X	EG55ZX-X	80 - 100	550 - 700	60	410	20
EG80X-X	EG552X-X					
EG82X-X	EG553X-X					

Classification	Classification Metric	Temperature		Charpy-V min.	
		°F	°C	ft-lb	J
EG6ZX-X	EG43ZX-X	Not specified			
EG7ZX-X	EG48ZX-X				
EG8ZX-X	EG55ZX-X				
EG60X-X	EG432X-X	0	-20	20	27
EG70X-X	EG482X-X	0	-20	20	27
EG80X-X	EG552X-X	0	-20	20	27
EG62X-X	EG433X-X	-20	-30	20	27
EG72X-X	EG483X-X	-20	-30	20	27
EG82X-X	EG553X-X	-20	-30	20	27

<b>EG</b>	<b>6</b>	<b>2</b>	<b>S</b>	<b>-1</b>
-----------	----------	----------	----------	-----------

EG = Electrode for Electro gas welding

**S** = Solid electrode  
**T** = cored electrode

## CHEMICAL COMPOSITION REQUIREMENTS FOR SOLID ELECTRODES

AWS Classification c)	Weight Percent, a) b)											
	C	Mn	P	S	Si	Ni	Mo	Cu	Ti	Zr	Al	Other
EGXXS-1	0.07-0.19	0.90-1.40	0.035	0.025	0.30-0.50	-	-	0,35	-	-	-	0,50
EGXXS-2	0,07	0.90-1.40	0.035	0.025	0.40-0.70	-	-	0,35	0.05-0.15	0.02-0.12	0.05-0.15	0,50
EGXXS-3	0.06-0.15	0.90-1.40	0.035	0.025	0.45-0.75	-	-	0,35	-	-	-	0,50
EGXXS-5	0.07-0.19	0.90-1.40	0.035	0.025	0.30-0.60	-	-	0,35	-	-	0.50-0.90	0,50
EGXXS-6	0.06-0.15	1.40-1.85	0.035	0.025	0.80-1.15	-	-	0,35	-	-	-	0,50
EGXXS-D2	0.07-0.12	1.60-2.10	0.035	0.025	0.50-0.80	0,15	0.40-0.60	-	-	-	-	0,50
EGXXS-G	As agreed between supplier and purchaser											

## NOTES:

- a) The filler metal shall be analyzed for the specific elements for which values are shown in this table. If the presence of other elements is indicated, in the course of this work, the amount of those elements shall be determined to ensure that their total (excluding iron) does not exceed the limit specified for "Other Elements, Total" in the last column of the table.
- b) Single values are maximums.
- c) The letters "XX" as used in the AWS classification column of this table refer respectively to the designator for tensile strength of the weld metals (see Tables 2 and 2M) and the designator for impact strength (see Tables 3 and 3M). d. SAE/ASTM Unified Numbering System for Metals and Alloys.
- d) SAE / ASTM Unified Numbering System for metals and alloys.
- e) The copper limit includes copper that may be applied as a coating on the electrode.
- f) Composition shall be reported; the requirements are those agreed to by the purchaser and the supplier

## CHEMICAL COMPOSITION REQUIREMENTS FOR WELD METAL FROM COMPOSITE FLUX CORED AND METAL CORED ELECTRODES

AWS Classification c)	Shielding Gas	Weight Percent, a) b)										
		C	Mn	P	S	Si	Ni	Cr	Mo	Cu	V	Other
EG6XT-1	None	(e)	1.7	0,03	0,03	0,50	0,30	0,20	0,35	0,35	0,08	0,50
EG7XT-1		(e)	1.7	0,03	0,03	0,50	0,30	0,20	0,35	0,35	0,08	0,50
EG8XT-1		(e)	1,8	0,03	0,03	0,90	0,30	0,20	0,25-0,65	0,35	0,08	0,50
EG6XT-2	CO <sub>2</sub>	(e)	2.0	0,03	0,03	0,90	0,30	0,20	0,35	0,35	0,08	0,50
EG7XT-2		(e)	2.0	0,03	0,03	0,90	0,30	0,20	0,35	0,35	0,08	0,50
EGXXT-Ni1		(e)	1.0-1.8	0,03	0,03	0,50	0,70-1.10	-	0,30	0,35	-	0,50
EGXXT-NM1	Ar/CO <sub>2</sub> or CO <sub>2</sub>	0,10	1.0-2.0	0,02	0,03	0.15-0.50	1.5-2.0	0,20	0.40-0.65	0,35	0,05	0,50
EGXXT-NM2	CO <sub>2</sub>	0,12	1.1-2.1	0,03	0,03	0.20-0.60	1.1-2.0	0,20	0.10-0.35	0,35	0,05	0,50
EGXXT-W		0,12	0.50-1.3	0,03	0,03	0.30-0.80	0.40-0.80	0.45-0.70	-	0.30-0.75	-	0,50
		As agreed between supplier and purchaser										

## NOTES:

- a) The weld metal shall be analyzed for the specific elements for which values are shown in this table. If the presence of other elements is indicated, in the course of this work, the amount of those elements shall be determined to ensure that their total (excluding iron) does not exceed the limit specified for "Other Elements, Total" in the last column of this table.
- b) Single values are maximums.
- c) The letters "XX" or "XXX" as used in the AWS classification column in this table refer respectively to the designator(s) for tensile strength of the weld metal (see Tables 2 and 2M) and the designator for impact strength (see Tables 3 and 3M). The single letter "X" as used in the AWS classification column refers to the designator for impact strength (see Tables 3 and 3M).
- d) SAE/ASTM Unified Numbering System for Metals and Alloys.
- e) Composition range of carbon not specified for these classifications, but the amount shall be determined and reported.
- f) Composition shall be reported; the requirements are those agreed to by the purchaser and supplier.

GUIDE TO AWS 5.28 : LOW-ALLOY STEEL ELECTRODES AND RODS FOR GAS SHIELDED ARC WELDING

ER = Wire electrode or rod  
E = Only electrode

C = Composit (cored) wire  
S = Solid wire

C = CO<sub>2</sub>  
M = 75-80% Ar/Rest CO<sub>2</sub>

Hydrogen content	
Symbol	ml/100g weld metal
H2	2
H4	4
H8	8
H16	16

**ER 80 S -B2 M HX**

TENSION AND IMPACT TEST REQUIREMENTS

AWS Classification		Shielding Gas	Tensile Strength		Yield Strength b)		Elongation b)	Testing Condition	Average Impact Strengtha, b)		
A5.28	A5.28 M		psi	MPa	psi	MPa			ft-lbf	J	
ER70S-B2L	ER49S-B2L	Argon/1-5% O2 (Classes SG-AO-1 thru SG-AO-5)	75	515	58	400	19	PWHT 150 ± 25 °F 620 ± 15 °C	Not Required		
ER70C-B2L	E49C-B2L										
ER70S-A1	ER49S-A1										
ER80S-B2	ER55S-B2		80	550	68	470	19				
E80C-B2	E55C-B2										
ER80S-B3L	ER55S-B3L		80	550	68	470	17	PWHT 275 ± 25 °F 690 ± 15 °C			
E80C-B3L	E55C-B3L										
ER90S-B	ER62S-B3		90	620	78	540	17				
E90C-B3	E62C-B3										
ER80S-B6	ER55S-B6		80	550	68	470	17	PWHT 1375 ± 25 °F 745 ± 15 °C			
E80C-B6	E55C-B6	80	550	68	470	17					
ER80S-B8	ER55S-B8	80	550	68	470	17	PWHT 375 ± 25 °F 745 ± 15 °C				
E80C-B8	E55C-B8	80	550	68	470	17					
ER90S-B9	ER62S-B9	Argon/5% CO2 (Class SG-AC-5)	90	620	60	410	16	PWHT 1400 ± 25 °F 760 ± 15 °C			
E90C-B9	E62C-B9	Argon/5-25% CO2 (Classes SG-AC-5 thru SG-AC-25)									
E70C-Ni2	E49C-Ni2	Argon/1-5% O2 (Classes SG-AO-1 thru SG-AO-5)	70	480	58	400	24	PWHT 1150 ± 25 °F 620 ± 15 °C	20 ft-lbf at -80°F	27 J at -60°C	
ER80S-Ni1	ER55S-Ni1		80	550	68	470	24	As-Welded	20 ft-lbf at -50°F	27 J at -45°C	
E80C-Ni1	E55C-Ni1										
ER80S-Ni2	ER55S-Ni2		80	550	68	470	24	PWHT 1150 ± 25 °F 620 ± 15 °C	20 ft-lbf at -80°F	27 J at -60°C	
E80C-Ni2	E55C-Ni2										
ER80S-Ni3	ER55S-Ni3										
E80C-Ni3	E55C-Ni3										
ER80S-D2	ER55S-D2	CO2 (Class SG-C)	80	550	68	470	17	As-Welded	20 ft-lbf at -20°F	27 J at -30°C	
ER90S-D2	ER62S-D2	Argon/1-5% O2 (Classes SG-AO-1 thru SG-AO-5)	90	620	78	540	17				
E90C-D2	E62C-D2										
ER100S-1	ER69S-1	Argon/2% O2 (Class SG-AO-2)	100	690	88	610	16	As-Welded			
ER110S-1	ER76S-1		110	760	95	660	15				
ER120S-1	ER76S-1		120	830	105	730	14				
E90C-K3	E62C-K3	Argon/5-25% CO2 (Classes SG-AC-5 thru SG-AC-25)	90	620	78	540	18	As-Welded			
E100C-K3	E69C-K3		100	690	88	610	16				
E110C-K3	E76C-K3		110	760	98	680	15				
E110C-K4	E76C-K4										
E120C-K4	E83C-K4		120	830	108	750	15				
E80C-W2	E55C-W2		80	550	68	470	22				20 ft-lbf at -20°F
ER70S-G	-	(d)	70	480	(e)	(e)	(e)	(e)			
E70C-G	-										
ER80S-G	-		80	550	(e)	(e)	(e)	(e)			
E80C-G	-										
ER90S-G	-		90	620	(e)	(e)	(e)	(e)			
E90C-G	-										
ER100S-G	-		100	690	(e)	(e)	(e)	(e)			
E100C-G	-										
ER110S-G	-		110	760	(e)	(e)	(e)	(e)			
E110C-G	-										
ER120S-G	-	120	830	(e)	(e)	(e)	(e)				
E120C-G	-										

NOTES:

- a) The use of a particular shielding gas for classification purposes shall not be construed to restrict the use of shielding gas mixtures. A filler metal tested with other gas blends, such as Argon/O2 or Argon/CO2 may result in weld metal having different strength and elongation. Classification with other gas blends shall be as agreed upon between the purchaser and supplier.
- b) Yield strength at 0.2% offset and elongation in 2 in. [51 mm] gage length.
- c) Postweld heat-treated condition in accordance with Table 7.
- d) Shielding gas shall be as agreed to between purchaser and supplier.
- e) Not specified (As agreed to between purchaser and supplier).

## GUIDE TO AWS 5.28: LOW-ALLOY STEEL ELECTRODES AND RODS FOR GAS SHIELDED ARC WELDING

ER = Wire electrode or rod  
E = only electrode

C = Composit (cored) wire  
S = Solid wire

C = CO<sub>2</sub>  
M = 75-80% Ar/Rest CO<sub>2</sub>

Hydrogen content	
Symbol	ml/100g weld metal
H2	2
H4	4
H8	8
H16	16

ER 80 S -B2 M HX

CHEMICAL COMPOSITION REQUIREMENTS FOR SOLID ELECTRODES AND RODS														
AWS Classification c)	Weight Percent, a) b)													
	C	Mn	Si	P	S	Ni	Cr	Mo	V	Ti	Zr	Al	Cu	Other
<b>Carbon-Molybdenum Steel Electrodes and Rods</b>														
ER70S-A1	0,12	1,30	0.30-0.70	0.025	0.025	0.20	-	0.40-0.65	-	-	-	-	0,35	0,50
<b>Chromium-Molybdenum Steel Electrodes and Rods</b>														
ER80S-B2	0.07-0.12	0.40-0.70	0.40-0.70	0.025	0.025	0,20	1.20-1.50	0.40-0.65	-	-	-	-	0,35	0,50
ER70S-B2L	0,05	0.40-0.70	0.40-0.70	0.025	0.025	0,20	1.20-1.50	0.40-0.65	-	-	-	-	0,35	0,50
ER90S-B3	0.07-0.12	0.40-0.70	0.40-0.70	0.025	0.025	0,20	2.30-2.70	0.90-1.20	-	-	-	-	0,35	0,50
ER80S-B3L	0,05	0.40-0.70	0.40-0.70	0.025	0.025	0,20	2.30-2.70	0.90-1.20	-	-	-	-	0,35	0,50
ER80S-B6f	0,10	0.40-0.70	0.50	0.025	0.025	0,60	4.50-6.00	0.45-0.65	-	-	-	-	0,35	0,50
ER80S-B8g	0,10	0.40-0.70	0.50	0.025	0.025	0,50	8.00-10.50	0.80-1.20	-	-	-	-	0,35	0,50
ER90S-B9h,i,j	0.07-0.13	1.20	0.15-0.50	0,010	0,010	0,80	8.00-10.50	0.80-1.20	0.15-0.30	-	-	0.04	0,20	0,50
<b>Nickel Steel Electrodes and Rods</b>														
ER80S-Ni1	0.12	1.25	0.40-0.80	0.025	0.025	0.80-1.10	0,15	0,35	0,05	-	-	-	0,35	0,50
ER80S-Ni2	0.12	1.25	0.40-0.80	0.025	0.025	2.00-2.75	-	-	-	-	-	-	0,35	0,50
ER80S-Ni3	0.12	1.25	0.40-0.80	0.025	0.025	3.00-3.75	-	-	-	-	-	-	0,35	0,50
<b>Manganese-Molybdenum Steel Electrodes and Rods</b>														
ER80S-D2	0.07-0.12	1.60-2.10	0.50-0.80	0.025	0.025	0,15	-	0.40-0.60	-	-	-	-	0,50	0,50
ER90S-D2														
<b>Other Low-Alloy Steel Electrodes and Rods</b>														
ER100S-1	0,08	1.25-1.80	0.20-0.55	0,010	0,010	1.40-2.10	0,30	0.25-0.55	0,05	0,10	0,10	0,10	0,25	0,50
ER110S-1	0,09	1.40-1.80	0.20-0.55	0,010	0,010	1.90-2.60	0,50	0.25-0.55	0,04	0,10	0,10	0,10	0,25	0,50
ER120S-1	0,10	1.40-1.80	0.25-0.60	0,010	0,010	2.00-2.80	0,60	0.30-0.65	0,03	0,10	0,10	0,10	0,25	0,50
EGXXS-G	As agreed between supplier and purchaser													
<b>NOTES:</b>														
a) The filler metal shall be analyzed for the elements for which values are shown in this table. If the presence of other elements is indicated in the course of this work, the amount of those elements shall be determined to ensure that their total (excluding iron) does not exceed the limits specified for "Other Elements, Total."														
b) Single values are maximum.														
c) The suffixes B2, Ni1, etc., designate the chemical composition of the electrode and rod classification.														
d) SAE HS-1086/ASTM DS-56H, Metals and Alloys in the Unified Numbering System.														
e) Copper due to any coating on the electrode or rod plus the copper content of the filler metal itself, shall not exceed the stated 0.50% max.														
f) Similar to former class ER502 in AWS Specification A5.9-93.														
g) Similar to former class ER505 in AWS Specification A5.9-93.														
h) Niobium (Columbium) 0.02-0.10%														
i) Nitrogen 0.03-0.07%														
j) The sum of Mn and Ni shall be less than or equal to 1.50% max.														
k) In order to meet the requirements of the "G" classification, the electrode must have a minimum of one or more of the following: 0.50% Nickel, 0.30% Chromium, or 0.20% Molybdenum. The composition shall be reported; the requirements are those agreed to by the purchaser and supplier.														

GUIDE TO EN AWS 5.28: LOW-ALLOY STEEL ELECTRODES AND RODS FOR GAS SHIELDED ARC WELDING

ER = Wire electrode or rod  
E = Only electrode

C = Composit (cored) wire  
S = Solid wire

C = CO<sub>2</sub>  
M = 75-80% Ar/Rest CO<sub>2</sub>

Hydrogen content	
Symbol	ml/100g weld metal
H2	2
H4	4
H8	8
H16	16

**ER 80 S -B2 M HX**

CHEMICAL COMPOSITION REQUIREMENTS FOR WELD METAL FROM COMPOSITE ELECTRODES a)														
AWS Classification c)	Weight Percent a) b)													
	C	Mn	Si	P	S	Ni	Cr	Mo	V	Ti	Zr	Al	Cu	Other
<b>Chromium-Molybdenum Steel Electrodes and Rods</b>														
ER80C-B2	0.05-0.12	0.40-1.00	0.25-0.60	0.025	0,030	0,20	1.00-1.50	0.40-0.65	0,030	-	-	-	-	0,50
ER70C-B2L	0,05	0.40-1.00	0.25-0.60	0.025	0,030	0,20	1.00-1.50	0.40-0.65	0,030	-	-	-	0,35	0,50
ER90C-B3	0.05-0.12	0.40-1.00	0.25-0.60	0.025	0,030	0,20	2.00-2.50	0.90-1.20	0,030	-	-	-	0,35	0,50
ER80C-B3L	0,05	0.40-1.00	0.25-0.60	0.025	0,030	0,20	2.00-2.50	0.90-1.20	0,030	-	-	-	0,35	0,50
ER80C-B6	0,10	0.40-1.00	0.25-0.60	0.025	0,025	0,60	4.50-6.00	0.45-0.65	0,030	-	-	-	0,35	0,50
ER80C-B8	0,10	0.40-1.00	0.25-0.60	0.025	0,025	0,50	8.00-10.50	0.80-1.20	0,030	-	-	-	0,35	0,50
ER90C-B9 f	0.08-0.13	1.20 g	0.50	0,020	0,015	0,80	8.00-10.50	0.80-1.20	0.15-0.30	-	-	0.04	0,20	0,50
<b>Nickel Steel Electrodes and Rods</b>														
ER80C-Ni1	0.12	1.50	0,90	0.025	0,030	0.80-1.10	-	0,30	0,03	-	-	-	0,35	0,50
ER70C-Ni2	0,08	1,25	0,90	0,025	0,030	1,75-2,75	-	-	0,30	-	-	-	0,35	0,50
ER80C-Ni2	0.12	1.50	0,90	0.025	0,030	1,75-2,75	-	-	0,03	-	-	-	0,35	0,50
ER80C-Ni3	0.12	1.50	0,90	0.025	0,015	3.00-3.75	-	-	0,03	-	-	-	0,35	0,50
<b>Manganese-Molybdenum Steel Electrodes and Rods</b>														
ER90C-D2	0.12	1.00-1.90	0,90	0.025	0,030	-	-	0.40-0.60	0,03	-	-	-	0,35	0,50
<b>Other Low-Alloy Steel Electrodes and Rods</b>														
E90C-K3	0,15	0.75-2.25	0,80	0.025	0,025	0.50-2.50	0.15	0.25-0.65	0,030	-	-	-	0,35	
E100C-K3	0,15	0.75-2.25	0,80	0.025	0,025	0.50-2.50	0.15	0.25-0.65	0,030	-	-	-	0,35	0,50
E110C-K3	0,15	0.75-2.25	0,80	0.025	0,025	0.50-2.50	0.15	0.25-0.65	0,030	-	-	-	0,35	0,50
E110C-K4	0,15	0.75-2.25	0,80	0.025	0,025	0.50-2.50	0.15-0.65	0.25-0.65	0,030	-	-	-	0,35	
E120C-K4	0,15	0.75-2.25	0,80	0.025	0,025	0.50-2.50	0.15-0.65	0.25-0.65	0,030	-	-	-	0,35	0,50
E80C-W2	0,12	0.50-1.30	0.35-0.80	0.025	0,030	0.40-0.80	0.45-0.70	-	0,030	-	-	-	0.30-0.75	
EXXC-G	-													

- NOTES:**
- a) Chemical requirements for composite electrodes are based on analysis of their weld metal in the as-welded condition using the shielding gas specified in Table 3.
  - b) The weld metal shall be analyzed for the specific elements for which values are shown in this table. If the presence of other elements is indicated in the course of this work, the amount of those elements shall be determined to ensure that their total (excluding iron) does not exceed the limit specified for "Other Elements, Total."
  - c) Single values are maximum.
  - d) Solid electrodes are generally recommended for gas tungsten arc welding (GTAW) or plasma arc welding (PAW).
  - f) Niobium (Columbium) 0.02-0.10%, Nitrogen 0.03-0.07%.
  - g) The sum of Mn and Ni shall be 1.50% max.
  - h) In order to meet the requirements of the "G" classification, the electrode must have a minimum of one or more of the following: 0.50% Nickel, 0.30% Chromium, or 0.20% Molybdenum. The composition shall be reported; the requirements are those agreed to by the purchaser and supplier.

GUIDE TO AWS 5.29: LOW-ALLOY STEEL ELECTRODES FOR FLUX CORED ARC WELDING

0 = is for flat and horizontal positions only  
1 = is for all positions (flat, horizontal, vertical with downward progression and/or vertical with upward progression)

T = (tubular ) This designator identifies the electrode as a flux cored electrode

Usability designator. This designator is some number from 1 through 14 or the letter "G"(or "GS"). This designator refers to the usability of the electrode with requirements for polarity and general operating characteristics

Hydrogen content	
Symbol	ml/100g weld metal
H2	2
H4	4
H8	8
H16	16

E = Wire electrode

C = CO<sub>2</sub>  
M = 75-80% Ar/Rest CO<sub>2</sub>

**E 81 T 5 Ni1 M -J HX**

AWS Classification	Tensile Strength		Min Yield Strength b)		Elongation b)	Testing Condition	Average Impact Strength, b)		
	ksi	MPa	ksi	MPa			ft-lbf	J	
A5.29									
E7XT5-A1C, -A1M	70-90	490-620	58	400	20	PWHT 1150 ± 25°F 620 ± 15°C	20 ft-lbf at -20°F	27 J at -30°C	
E8XT1-A1C, -A1M	80-100	550-690	68	470	19	PWHT 1275 ± 25°F 690 ± 15°C	Not Specified		
E8XT1-B1C, -B1M, -B1LC, -B1LM	80-100	550-690	68	470	19				
E8XT1-B2C, -B2M, -B2HC, -B2HM, -B2LC, -B2LM	80-100	550-690	68	470	19				
E8XT5-B2C, -B2M, -B2LC, -B2LM	80-100	550-690	68	470	19				
E9XT1-B3C, -B3M, -B3LC, -B3LM, -B3HC, -B3HM	90-110	620-760	78	540	17				
E9XT5-B3C, -B3M	90-110	620-760	78	540	17				
E10XT1-B3C, -B3M	100-120	690-830	88	610	16				
E8XT1-B6C,e -B6M,e -B6LC,e -B6LM,e	80-100	550-690	68	470	19		PWHT 1375 ± 25°Fd 745± 15°Cd		
E8XT5-B6C,e -B6M,e -B6LC,e -B6LM,e	80-100	550-690	68	470	19				
E8XT1-B8C,e -B8M,e -B8LC,e -B8LM,e	80-100	550-690	68	470	19				
E8XT5-B8C,e -B8M,e -B8LC,e -B8LM,e	80-100	550-690	68	470	19				
E9XT1-B9C, -B9M	90-120	620-830	78	540	17				
E6XT1-Ni1C, -Ni1M	60-80	430-550	50	340	22		AW As Welded	20 ft-lbf @ -20°F	27 J at -30°C
E7XT6-Ni1	70-90	490-620	58	400	20		AW As Welded	20 ft-lbf @ -20°F	27 J at -30°C
E7XT8-Ni1	70-90	490-620	58	400	20	20 ft-lbf @ -20°F		27 J at -30°C	
E8XT1-Ni1C, -Ni1M	80-100	550-690	68	470	19	20 ft-lbf @ -20°F		27 J at -30°C	
E8XT5-Ni1C, -Ni1M	80-100	550-690	68	470	19	20 ft-lbf @ -60°F		27 J at -50°C	
E7XT8-Ni2	70-90	490-620	58	400	20	AW As Welded	20 ft-lbf @ -20°F	27 J at -30°C	
E8XT8-Ni2	80-100	550-690	68	470	19		20 ft-lbf @ -20°F	27 J at -30°C	
E8XT1-Ni2C, -Ni2M	80-100	550-690	68	470	19		20 ft-lbf @ -40°F	27 J at -40°C	
E8XT5-Ni2C,f -Ni2Mf	80-100	550-690	68	470	19		PWHT 1150 ± 25°F 620 ± 15°C	20 ft-lbf @ -75°F	27 J at -60°C
E9XT1-Ni2C, -Ni2M	90-110	620-760	78	540	17	AW As Welded	20 ft-lbf @ -40°F	27 J at -40°C	
E8XT5-Ni3C,f -Ni3Mf	80-100	550-690	68	470	19	PWHT 1150 ± 25°F 620 ± 15°C	20 ft-lbf @ -100°F	27 J at -70°C	
E9XT5-Ni3C,f -Ni3Mf	90-110	620-760	78	540	17	AW As Welded	20 ft-lbf @ -100°F	27 J at -70°C	
E8XT11-Ni3	80-100	550-690	68	470	19		20 ft-lbf @ 0°F	27 J at -20°C	
E9XT1-D1C, -D1M	90-110	620-760	78	540	17		20 ft-lbf @ -40°F	27 J at -40°C	
E9XT5-D2C, -D2M	90-110	620-760	78	540	17	PWHT 1150 ± 25°F 620 ± 15°C	20 ft-lbf @ -60°F	27 J at -50°C	
E10XT5-D2C, -D2M	100-120	690-830	88	610	16	AW As Welded	20 ft-lbf @ -40°F	27 J at -40°C	
E9XT1-D3C, -D3M	90-110	620-760	78	540	17		20 ft-lbf @ -20°F	27 J at -30°C	
E8XT5-K1C, -K1M	80-100	550-690	68	470	19		20 ft-lbf @ -40°F	27 J at -40°C	
E7XT7-K2	70-90	490-620	58	400	20		20 ft-lbf @ -20°F	27 J at -30°C	
E7XT4-K2	70-90	490-620	58	400	20		20 ft-lbf @ 0°F	27 J at -20°C	
E7XT8-K2	70-90	490-620	58	400	20	20 ft-lbf @ -20°F	27 J at -30°C		
E7XT11-K2	70-90	490-620	58	400	20	20 ft-lbf @ +32°F	27 J at 0°C		



GUIDE TO AWS 5.29: LOW-ALLOY STEEL ELECTRODES FOR FLUX CORED ARC WELDING

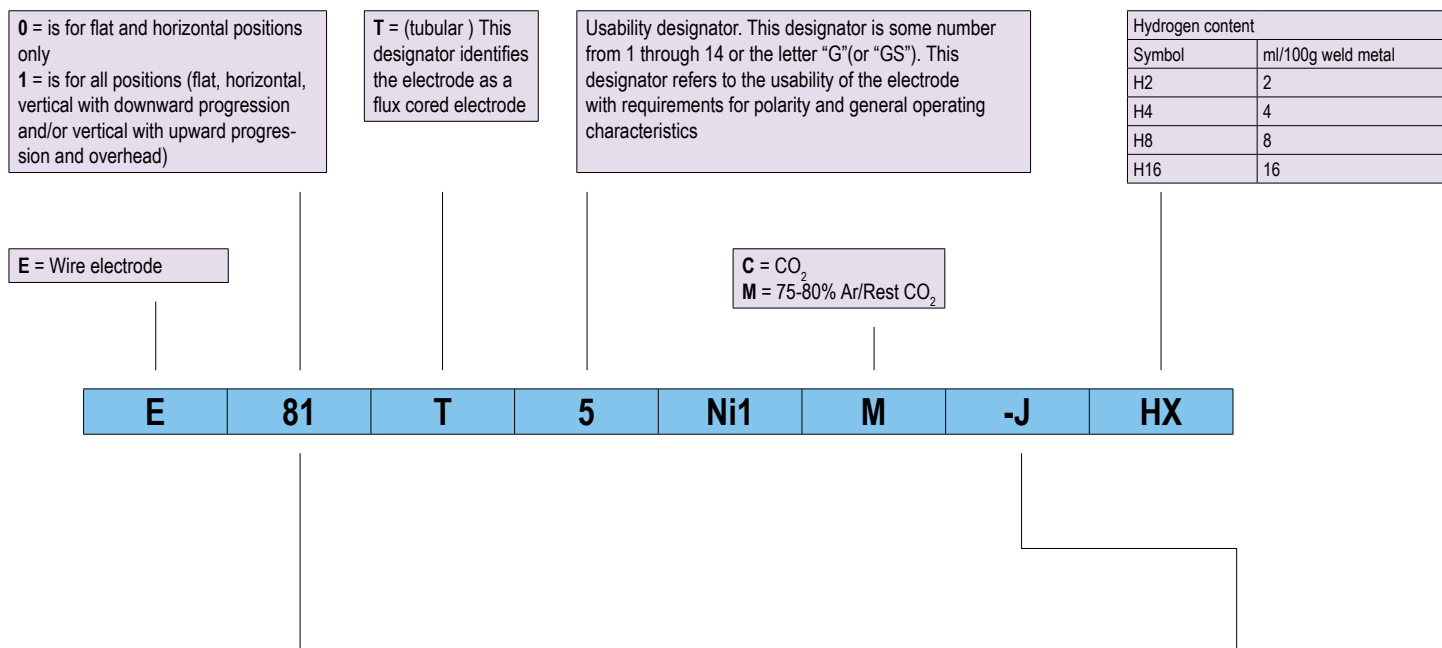

AWS Classification a) b)	Tensile Strength		Min Yield Strength b)		Elongation b)	Testing Condition	Average Impact Strength b)	
	ksi	MPa	ksi	MPa			ft-lbf	J
A5.29						As welded (AW)		
E8XT1-K2C, -K2M	80-100	550-690	68	470	19		20 ft-lbf @ -20°F	27 J @ -30°C
E8XT5-K2C, -K2M	80-100	550-690	68	470	19		20 ft-lbf @ -20°F	27 J @ -30°C
E9XT1-K2C, -K2M	90-110	620-760	78	540	17		20 ft-lbf @ 0°F	27 J @ -20°C
E9XT5-K2C, -K2M	90-110	620-760	78	540	17		20 ft-lbf @ -60°F	27 J @ -50°C
E10XT1-K3C, -K3M	100-120	690-830	88	610	16		20 ft-lbf @ 0°F	27 J @ -20°C
E10XT5-K3C, -K3M	100-120	690-830	88	610	16		20 ft-lbf @ -60°F	27 J @ -50°C
E11XT1-K3C, -K3M	110-130	760-900	98	680	15		20 ft-lbf @ 0°F	27 J @ -20°C
E11XT5-K3C, -K3M	110-130	760-900	98	680	15		20 ft-lbf @ -60°F	27 J @ -50°C
E11XT1-K4C, -K4M	110-130	760-900	98	680	15		20 ft-lbf @ 0°F	27 J @ -20°C
E11XT5-K4C, -K4M	110-130	760-900	98	680	15		20 ft-lbf @ -60°F	27 J @ -50°C
E12XT5-K4C, -K4M	120-140	830-970	108	745	14		20 ft-lbf @ -60°F	27 J @ -50°C
E12XT1-K5C, -K5M	120-140	830-970	108	745	14		Not Specified	Not Specified
E7XT5-K6C, -K6M	70-90	490-620	58	400	20		20 ft-lbf @ -75°F	27 J @ -60°C
E6XT8-K6	60-80	430-550	50	340	22		20 ft-lbf @ -20°F	27 J @ -30°C
E7XT8-K6	70-90	490-620	58	400	20		20 ft-lbf @ -20°F	27 J @ -30°C
E10XT1-K7C, -K7M	100-120	690-830	88	610	16		20 ft-lbf @ -60°F	27 J @ -50°C
E9XT8-K8	90-110	620-760	78	540	17		20 ft-lbf @ -20°F	27 J @ -30°C
E10XT1-K9C, -K9M	100-120 g	690-830 g	82-97	560-670	18		35 ft-lbf @ -60°F	47 J @ -50°C
E8XT1-W2C, -W2M	80-100	550-690	68	470	19		20 ft-lbf @ -20°F	27 J @ -30°
EXXTX-G,h -GC,h -GMh	The weld deposit composition, condition of test (AW or PWHT) and Charpy V-Notch impact properties are as agreed upon between the supplier and purchaser. Requirements for the tension test, positionality, slag system and shielding gas, if any, conform to those indicated by the digits used.							
EXXTG-Xh	The slag system, shielding gas, if any, condition of test (AW or PWHT) and Charpy VNotch impact properties are as agreed upon between the supplier and purchaser. Requirements for the tension test, positionality and weld deposit composition conform to those indicated by the digits used.							
EXXTG-Gh	The slag system, shielding gas, if any, condition of test (AW or PWHT), Charpy V-Notch impact properties and weld deposit composition are as agreed upon between the supplier and purchaser. Requirements for the tension test and positionality conform to those indicated by the digits used.							

**NOTES:**

- a) The „Xs“ in actual classification will be replaced with the appropriate designators. See Fig. 1.
- b) The placement of a „G“ in a designator position indicates that those properties have been agreed upon between the supplier and purchaser.
- c) AW p As Welded. PWHT p Postweld heat treated in accordance with Table 6 and 9.4.1.2.
- d) Electrodes with the optional supplemental designator „J“ shall meet the minimum Charpy V-Notch impact energy requirement for its classification at a test temperature 20°F lower than the test temperature shown in Table 1U for its classification.
- e) These electrodes are presently classified E502TX-X or E505TX-X in AWS A5.22-95. With the next revision of A5.22 they will be removed and exclusively listed in this specification.
- f) PWHT temperatures in excess of 1150°F will decrease the Charpy V-Notch impact properties.
- g) For this classification (E10XT1-K9C, -K9M) the tensile strength range shown is not a requirement. It is an approximation.
- h) The tensile strength, yield strength, and % elongation requirements for EXXTX-G, -GC, -GM; EXXTG-X and EXXTG-G electrodes are as shown in this table for other electrode classifications (not including the E10XT1-K9C, -K9M classifications) having the same tensile strength designator.

## GUIDE TO AWS 5.29: LOW-ALLOY STEEL ELECTRODES FOR FLUX CORED ARC WELDING

0 = is for flat and horizontal positions only  
1 = is for all positions (flat, horizontal, vertical with downward progression and/or vertical with upward progression and overhead)

T = (tubular) This designator identifies the electrode as a flux cored electrode

Usability designator. This designator is some number from 1 through 14 or the letter "G" (or "GS"). This designator refers to the usability of the electrode with requirements for polarity and general operating characteristics

Hydrogen content	
Symbol	ml/100g weld metal
H2	2
H4	4
H8	8
H16	16

E = Wire electrode

C = CO<sub>2</sub>  
M = 75-80% Ar/Rest CO<sub>2</sub>

**E 81 T 5 Ni1 M -J HX**

AWS Classification	Chemical composition % a)											
	C	Mn	P	S	Si	Ni	Cr	Mo	V	Al	Cu	Other
<b>Carbon-Molybdenum Steel Electrodes and Rods</b>												
A1	0,12	1,25	0,030	0,030	0,80	-	-	0,40-0,65	-	-	-	-
<b>Chromium-Molybdenum Steel Electrodes and Rods</b>												
B1	0,05-0,12	1,25	0,030	0,030	0,80	-	0,40-0,65	0,40-0,65	-	-	-	-
B1L	0,05	1,25	0,030	0,030	0,80	-	0,40-0,65	0,40-0,65	-	-	-	-
B2	0,05-0,12	1,25	0,030	0,030	0,80	-	1,00-1,50	0,40-0,65	-	-	-	-
B2L	0,05	1,25	0,030	0,030	0,80	-	1,00-1,50	0,40-0,65	-	-	-	-
B2H	0,10-0,15	1,25	0,030	0,030	0,80	-	1,00-1,50	0,40-0,65	-	-	-	-
B3	0,05-0,12	1,25	0,030	0,030	0,80	-	2,00-2,50	0,90-1,20	-	-	-	-
B3L	0,05	1,25	0,030	0,030	0,80	-	2,00-2,50	0,90-1,20	-	-	-	-
B3H	0,10-0,15	1,25	0,030	0,030	0,80	-	2,00-2,50	0,90-1,20	-	-	-	-
B6	0,05-0,12	1,25	0,040	0,030	1,00	0,40	4,0-6,0	0,40-0,65	-	-	0,50	-
B6L	0,05	1,25	0,040	0,030	1,00	0,40	4,0-6,0	0,40-0,65	-	-	0,50	-
B8	0,05-0,12	1,25	0,040	0,030	1,00	0,40	8,0-10,5	0,85-1,20	-	-	0,50	-
B8L	0,05	1,25	0,030	0,030	1,00	0,40	8,0-10,5	0,85-1,20	-	-	0,50	-
B9	0,08-0,13	1,20 d	0,020	0,015	0,50	0,80	8,0-10,5	0,85-1,20	0,15-0,30	0,04	0,25	Nb: 0,02-0,10 N: 0,02-0,07
<b>Nickel Steel Electrodes and Rods</b>												
Ni1	0,12	1,50	0,030	0,030	0,80	0,80-1,10	0,15	0,35	0,05	1,8 c	-	-
Ni2	0,12	1,50	0,030	0,030	0,80	1,75-2,75	-	-	-	1,8 c	-	-
Ni3	0,12	1,50	0,030	0,030	0,80	2,75-3,75	-	-	-	1,8 c	-	-
<b>Manganese-Molybdenum Steel Electrodes and Rods</b>												
D1	0,12	1,25-2,00	0,030	0,030	0,80	-	-	0,25-0,55	-	-	-	-
D2	0,15	1,65-2,25	0,030	0,030	0,80	-	-	0,25-0,55	-	-	-	-
D3	0,12	1,00-1,75	0,030	0,030	0,80	-	-	0,40-0,65	-	-	-	-
<b>Other Low-Alloy Steel Electrodes and Rods</b>												
K1	0,15	0,80-1,40	0,030	0,030	0,80	0,80-1,10	0,15	0,20-0,65	0,05	-	-	-
K2	0,15	0,50-1,75	0,030	0,030	0,80	1,00-2,00	0,15	0,35	0,05	1,8 c	-	-
K3	0,15	0,75-2,25	0,030	0,030	0,80	1,25-2,60	0,15	0,25-0,65	0,05	-	-	-
K4	0,15	1,20-2,25	0,030	0,030	0,80	1,25-2,60	0,20-0,60	0,20-0,65	0,03	-	-	-
K5	0,10-0,25	0,60-1,60	0,030	0,030	0,80	0,75-2,00	0,20-0,70	0,15-0,55	0,05	-	-	-
K6	0,15	0,50-1,50	0,030	0,030	0,80	0,40-1,00	0,20	0,15	0,05	1,8 c	-	-
K7	0,15	1,00-1,75	0,030	0,030	0,80	2,00-2,75	-	-	-	-	-	-
K8	0,15	1,00-2,00	0,030	0,030	0,40	0,50-1,50	0,20	0,20	0,05	1,8 c	-	-
K9	0,07	0,50-1,50	0,015	0,015	0,60	1,30-3,75	0,20	0,50	0,05	-	0,06	-
W2	0,12	0,50-1,30	0,030	0,030	0,35-0,80	0,40-0,80	0,45-0,70	-	-	-	0,30-0,75	-
Ge	-	0,50 f	0,030	0,030	1,00	0,50 f	0,30 f	0,20 f	0,10 f	1,8 c	-	-

**NOTES:**

- Single values are maximum unless otherwise noted.
- ASTM DS-56 or SAE HS-1086. An „X,“ when present in the last position, represents the usability designator for the electrode type used to deposit the weld metal. An exception to this applies to the T11 electrode type where a „9“ is used instead of an „11.“
- Applicable to self-shielded electrodes only. Electrodes intended for use with gas shielding normally do not have significant additions of aluminum.
- Mn + Ni p 1.5% maximum. See A7.9.2 in Annex A.
- In order to meet the alloy requirements of the G group, the undiluted weld metal shall have not less than the minimum specified for one or more of the following alloys: Mn, Ni, Cr, Mo, or V.
- Minimum values

## GUIDE TO AWS 5.29: LOW-ALLOY STEEL ELECTRODES FOR FLUX CORED ARC WELDING

## Supplementary information :

COMPARISON OF APPROXIMATE EQUIVALENT CLASSIFICATIONS, a), b) FOR ISO/DIS 17632, c)				NOTES:
ISO/DIS 17632A c	ISO/DIS 17632B	AWS A5.29	AWS A5.29M	
	T493T5-XXP-2M3	E7XT5-A1X	E49XT5-A1X	<p>a) The requirements for the equivalent classifications shown are not necessarily identical in every respect.</p> <p>b) An „X“ in the designations indicates the type of electrode core, the positionality or the type of shielding gas used (if any). The symbols „A“ and „P“ in ISO 17632B designations indicate whether the mechanical properties were achieved in the as-welded (A) or post-weld heat treated (P) condition, and the symbol „N“ following an „X“ applies (in ISO 17632B classifications) when no shielding gas is required.</p> <p>c) ISO/DIS 17632, Welding consumables - Tubular cored electrodes for gas shielded and non-gas shielded metal arc welding of non-alloy and fine grain steels - Classification</p>
T46Z Mo X X	T552T1-XXA-2M3	E8XT1-A1X	E55XT1-A1X	
	T433T8-XNA-N1	E6XT8-K6	E43XT8-K6	
	T493T8-XNA-N1	E7XT8-K6	E49XT8-K6	
	T496T5-XXA-N1	E7XT5-K6X	E49XT5-K6X	
T35 3 1Ni X X	T433T1-XXA-N2	E6XT1-Ni1X	E43XT1-Ni1X	
T38 3 1Ni X X	E493T6-XNA-N2	E7XT6-Ni1	E49XT6-Ni1	
	T493T8-XNA-N2	E7XT8-Ni1	E49XT8-Ni1	
	T553T1-XXA-N2	E8XT1-Ni1X	E55XT1-Ni1X	
T46 3 1Ni X X	T556T5-XXP-N2	E8XT5-Ni1X	E55XT5-Ni1X	
	T493T8-XNA-N5	E7XT8-Ni2	E49XT8-Ni2	
	T553T8-XNA-N5	E8XT8-Ni2	E55XT8-Ni2	
T46 4 2Ni X X	T554T1-XXA-N5	E8XT1-Ni2X	E55XT1-Ni2X	
T46 6 3Ni X X	T557T5-XXP-N7	E8XT5-Ni3X	E55XT5-Ni3X	
T50 3 1NiMo X X	T554T5-XXA-N2M2	E8XT5-K1X	E55XT5-K1X	
	T492T4-XNA-N3M1	E70T4-K2	E490T4-K2	
	T493T7-XNA-N3M1	E7XT7-K2	E49XT7-K2	
	T493T8-XNA-N3M1	E7XT8-K2	E49XT8-K2	
	T553T1-XXA-N3M1	E8XT1-K2X	E55XT1-K2X	
	T553T5-XXA-N3M1	E8XT5-K2X	E55XT5-K2X	
	T553T1-XXA-NCC1	E8XT1-W2X	E55XT1-W2X	

COMPARISON OF APPROXIMATE EQUIVALENT CLASSIFICATIONS, a), b), FOR ISO 17634, c)				NOTES:
ISO 17634 A c	ISO/DIS 17634 B	AWS A5.29	AWS A5.29M	
T Mo X X	T55TX-XX-2M3	E8XTX-A1X	E55XTX-A1X	<p>a) The requirements for the equivalent classifications shown are not necessarily identical in every respect.</p> <p>b) An „X“ in the designations indicates the type of electrode core, the usability of the electrode, the positionality and the type of shielding gas used (if any), as applicable.</p> <p>c) ISO 17634, Welding consumables - Tubular cored electrodes for gas shielded metal arc welding of creep resisting steels - Classification.</p>
T MoL X X	T49TX-XX-2M3	E7XTX-A1X	E49XTX-A1X	
	T55TX-XX-CM	E8XTX-B1X	E55XTX-B1X	
	T55TX-XX-CML	E8XTX-B1LX	E55XTX-B1LX	
T CrMo1 X X	T55TX-XX-1CM	E8XTX-B2X	E55XTX-B2X	
T CrMo1L X X	T55TX-XX-1CML	E8XTX-B2LX	E55XTX-B2LX	
	T55TX-XX-1CMH	E8XTX-B2HX	E55XTX-B2HX	
T CrMo2 X X	T55TX-XX-2C1M	E8XTX-B3X	E55XTX-B3X	
T CrMo2L X X	T55TX-XX-2C1ML	E8XTX-B3LX	E55XTX-B3LX	
	T55TX-XX-2C1MH	E8XTX-B3HX	E55XTX-B3HX	
T CrMo 5 X X	T55TX-XX-5CM	E8XTX-B6X	E55XTX-B6X	
	T55TX-XX-5CML	E8XTX-B6LX	E55XTX-B6LX	
	T55TX-XX-9C1M	E8XTX-B8X	E55XTX-B8X	
	T55TX-XX-9C1ML	E8XTX-B8LX	E55XTX-B8LX	
	T55TX-XX-9C1MV	E9XTX-B9X	E62XTX-B9X	

COMPARISON OF APPROXIMATE EQUIVALENT CLASSIFICATIONS, a), b) FOR ISO 18276, c)				NOTES:
ISO 17634 A c	ISO/DIS 17634 B	AWS A5.29	AWS A5.29M	
T Mo X X	T55TX-XX-2M3	E8XTX-A1X	E55XTX-A1X	<p>a) The requirements for the equivalent classifications shown are not necessarily identical in every respect.</p> <p>b) An „X“ in the designations indicates the type of electrode core, the positionality and the type of shielding gas used (if any). The symbols „A“ and „P“ in ISO 18276B designations indicate whether the mechanical properties were achieved in the as-welded (A) or the post-weld heat treated (P) condition, and the symbol N following an X applies when no shielding gas is required.</p> <p>c) ISO/DIS 18276, Welding consumables - Tubular cored electrodes for gas shielded and non-gas shielded metal arc welding of high strength steels - Classification</p>
T MoL X X	T49TX-XX-2M3	E7XTX-A1X	E49XTX-A1X	
	T55TX-XX-CM	E8XTX-B1X	E55XTX-B1X	
	T55TX-XX-CML	E8XTX-B1LX	E55XTX-B1LX	
T CrMo1 X X	T55TX-XX-1CM	E8XTX-B2X	E55XTX-B2X	
T CrMo1L X X	T55TX-XX-1CML	E8XTX-B2LX	E55XTX-B2LX	
	T55TX-XX-1CMH	E8XTX-B2HX	E55XTX-B2HX	
T CrMo2 X X	T55TX-XX-2C1M	E8XTX-B3X	E55XTX-B3X	
T CrMo2L X X	T55TX-XX-2C1ML	E8XTX-B3LX	E55XTX-B3LX	
	T55TX-XX-2C1MH	E8XTX-B3HX	E55XTX-B3HX	
T CrMo 5 X X	T55TX-XX-5CM	E8XTX-B6X	E55XTX-B6X	
	T55TX-XX-5CML	E8XTX-B6LX	E55XTX-B6LX	
	T55TX-XX-9C1M	E8XTX-B8X	E55XTX-B8X	
	T55TX-XX-9C1ML	E8XTX-B8LX	E55XTX-B8LX	
	T55TX-XX-9C1MV	E9XTX-B9X	E62XTX-B9X	

## GUIDE TO AWS 5.31: FLUXES FOR BRAZING AND BRAZE WELDING

FB = The letters FB at the beginning of each classification designation stands for "Flux for Brazing or Braze Welding."

The third character is a number that stands for a group of applicable base metals

FB 1 A

The fourth character, a letter, designates a change in form and attendant composition within the broader base metal classification

AWS Classification*	Form	Filler Metal Type	Activity Temperature Range		Flux 3B in the Brazing Manual, 3rd Edition, 1976 has been discontinued. Type 3B has been divided into types FB3-C and FB3-D.
			°F	°C	
FB1-A	Powder	BAISi	1080–1140	580–615	<b>NOTES:</b> a. The selection of a flux designation for a specific type of work may be based on the form, the filler metal type, and the classification above, but the information here is generally not adequate for flux selection. Refer to Section A6 and the latest issue of the Brazing Handbook for further assistance. b. See 11.2 and 11.3 for the difference between paste flux and slurry flux.
FB1-B	Powder	BAISi	1040–1140	560–615	
FB1-C	Powder	BAISi	1000–1140	540–615	
FB2-A	Powder	BMg	900–1150	480–620	
FB3-A	Paste	BAG and BCuP	1050–1600	565–870	
FB3-C	Paste	BAG and BCuP BAG, BCu, BNi,	1050–1700	565–925	
FB3-D	Paste	BAu & RBCuZn	1400–2200	760–1205	
FB3-E	Liquid	BAG and BCuP	1050–1600	565–870	
FB3-F	Powder	BAG and BCuP	1200–1600	650–870	
FB3-G	Slurry	BAG and BCuP	1050–1600	565–870	
FB3-H	Slurry	BAG, BCu, BNi,	1050–170	565–925	
FB3-I	Slurry	BAu & RBCuZn BCu, BNi	1400–2200	760–1205	
FB3-J	Powder	BAu & RBCuZn	1400–2200	760–1205	
FB3-K	Liquid	BAG & RBCuZn	1400–2200	760–1205	
FB4-A	Paste	BAG and BCuP	1100–1600	595–870	

**Supplementary information: look also Iso 17672**

**FB1-A** is a brazing flux in powder form intended for torch and furnace brazing of aluminum and its brazeable alloys. It consists primarily of fluorides and chlorides of some of the alkali metals. Water or alcohol may be used for thinning

**FB1-B** is a brazing flux in powder form intended for furnace brazing of aluminum and its brazeable alloys. The lower end of its activity temperature range is slightly lower than that of the FB1-A classification. It consists primarily of fluorides and chlorides of some of the alkali metals. Water or alcohol may be used for thinning

**FB1-C** is a brazing flux in powder form intended for salt-bath dip brazing of aluminum and its brazeable alloys. The lower end of its activity temperature range is much lower than that of the FB1-A and FB1-B classifications. It consists primarily of fluorides and chlorides of some of the alkali metals. Water should be avoided in the flux or removed prior to immersion of the brazement in the salt bath.

**FB2-A** is a brazing flux in powder form intended for salt-bath dip brazing of magnesium alloys whose designators start with AZ. It consists primarily of fluorides and chlorides of some of the alkali metals. Water should be avoided in the flux or removed prior to immersion of the brazement in the salt bath.

**FB3-A** is a general purpose brazing flux in paste form intended for use with most brazing processes in the brazing of steels, copper, copper alloys, nickel, and nickel alloys. It is not suitable for aluminum bronze or other base metals containing alloying elements, such as aluminum, which form refractory oxides. It consists primarily of boric acid, borates, and complex fluorine compounds. Water is used for thinning.

**FB3-C** is a brazing flux in paste form similar to FB3-A, except that the activity temperature range extends to a higher temperature, and it may contain elemental boron. Water is used for thinning.

**FB3-D** is a brazing flux in paste form intended for torch, furnace and induction brazing of steels, nickel and its alloys, and carbides using high-temperature filler metals. It consists primarily of boric acid, borates, and complex fluorine compounds. It may contain elemental boron. Water is used for thinning

**FB3-E** is a low-activity liquid brazing flux used in the torch brazing of jewelry or to augment borderline furnace brazing atmospheric conditions. Flux usually is applied by dipping or by the use of semi- or fully-automatic spray dispensing equipment. The flux constituents are similar to those in FB3-D fluxes.

**FB3-F** is a brazing flux somewhat similar to the FB3-A flux, except that no vehicle is added to the powder during manufacture. In application, water maybe used as a thinning vehicle.

**FB3-G** is a brazing flux in slurry form for use with automatic spray dispensing equipment. The general areas of application are similar to those of FB3-A flux. Water may be used as the thinning vehicle.

**FB3-H** is a brazing flux in slurry form for use with automatic spray dispensing equipment. The general areas of application are similar to those of the FB3-C flux. The flux typically contains complex borates and fluoride compounds plus powdered boron. Water may be used as the thinning vehicle.

**FB3-I** is a brazing flux in slurry form for use with automatic spray dispensing equipment. The general areas of application are similar to those of the FB3-D flux. The flux typically contains complex borates and fluoride compounds plus powdered boron. Water may be used as the thinning vehicle.

**FB3-J** is a brazing flux in powder form for areas of application similar to those of the FB3-D flux. The flux typically contains complex borates and fluoride compounds plus powdered boron. Water may be used as the thinning vehicle.

**FB3-K** is a liquid flux used almost exclusively in torch brazing. The fuel gas is passed through the container of liquid flux entraining flux in the fuel gas. The flux is applied by the flame where needed on base metals such as carbon steels, low alloy steels, cast iron, copper and copper alloys, nickel and nickel alloys, and precious metals. The flux consists primarily of liquid borates.

**FB4-A** is a brazing flux in paste form intended for brazing of copper alloys and other base metals containing up to 9 percent aluminum, e.g., aluminum bronze. It may also be suitable for base metals containing up to 3% titanium or other metals that form refractory oxides. It consists primarily of borates, complex fluorine compounds, and complex chlorine compounds. Water is used for thinning

GUIDE TO AWS 5.32: WELDING SHIELDING GASES

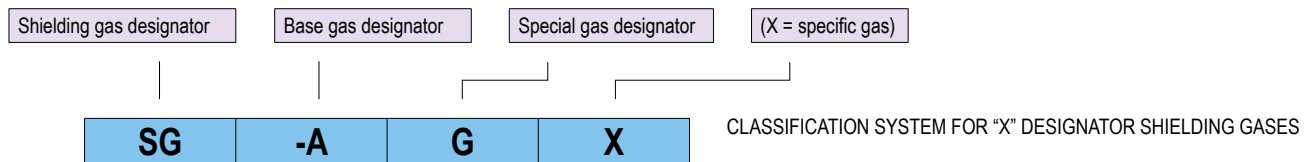
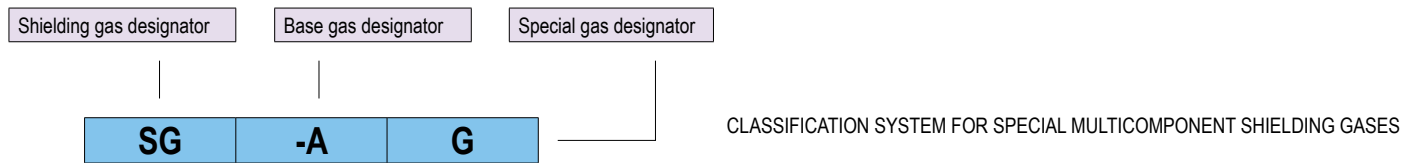
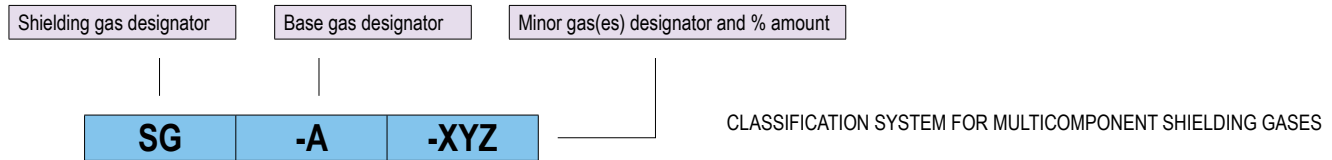

AWS CLASSIFICATIONS FOR TYPICAL GAS MIXTURES			Individual gas components are identified by the following codes:
AWS Classification	Typical Gas Mixtures %	Gas	
SG-AC-25	75/25	Argon + Carbon Dioxide	<b>A — Argon</b> <b>C — Carbon Dioxide</b> <b>He — Helium</b> <b>H — Hydrogen</b> <b>N — Nitrogen</b> <b>O — Oxygen</b>
SG-AO-2	98/2	Argon + Oxygen	
SG-AHe-10	90/10	Argon + Helium	
SG-AH-5	95/5	Argon + Hydrogen	
SG-HeA-25	75/25	Helium + Argon	
SG-HeAC-7.5/2.5	90/7.5/2.5	Helium + Argon + Carbon Dioxide	
SG-ACO-8/2	90/8/2	Argon + Carbon Dioxide + Oxygen	
SG-A-G	Special	Argon + Mixture	

## GUIDE TO AWS 5.34: NICKEL-ALLOY ELECTRODES FOR FLUX CORED ARC WELDING

The symbol for the chemical composition of the all-weld metal shall comprise "Ni" plus for digits as shown in Tab 1 Norm. The first digit is an indicator of the class of alloy deposited:

- 2 No significant alloy addition
- 4 Significant copper addition
- 6 Significant chromium addition, with iron less than 25% (NiCrFe and NiCrMo alloys)
- 8 Significant chromium addition, with iron more than 25% (NiFeCr alloys)
- 10 Significant molybdenum addition without significant chromium addition (NiMo alloys)

The remaining digits indicate the particular alloy deposited. Look Annex of the Norm

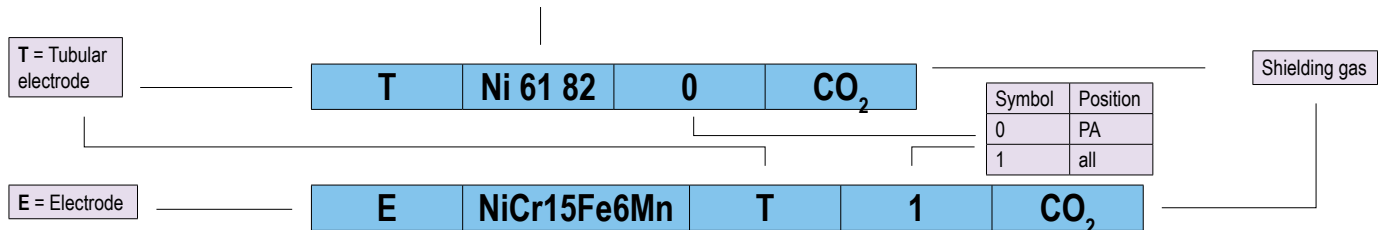

Alloy code				Chemical composition % (m/m)																
AWS ISO	AWS	ISO numerical	ISO chemical	C	Mn	Fe	Si	Cu	Ni	Co	Al	Ti	Cr	Nb(Cb)	Mo	V	W	others		
Nickel-Copper																				
		Ni 4060	NiCu30Mn3Ti	0,15	4.0	2.5	1.5	27,0 - 34,0	≥62,0	-	-	1.0	-	-	-	-	-	-	-	
		Ni 4061	NiCu27Mn3NbTi	0,15	4.0	2.5	1.3	24,0 - 31,0	≥62,0	-	-	1.5	-	3.0	-	-	-	-	-	
Nickel-Chrome																				
TNi 6082-XY	ENiCr3Tx-y	Ni 4082	NiCr20Mn3Nb	0,10	2,5 - 3,5	3,0	0,50	0,50	≥67,0	<0,10	-	0,75	18,0 - 22,0	2,0 - 3,0	2,0	-	-	-	P 0,03	
		Ni 4083	NiCr20Mn6Fe4Nb	0,10	4,0 - 8,0	4,0	0,8	0,50	≥60,0	-	-	0,5	18,0 - 22,0	1,5 - 3,0	2,0	-	-	-	-	
Nickel-Molybdenum																				
		Ni 1013	NiMo17Cr7W	0,10	2,0 - 3,0	10,0	0,75	0,50	≥58,0	-	-	-	4,0 - 8,0	-	16,0 - 19,0	-	2,0 - 4,0	-	-	
Nickel-Chrome-Iron																				
TNi 6062-XY	ENiCrFe1Tx-y	Ni 6062	NiCr15Fe8Nb	0,08	3,5	11,0	0,75	0,50	≥62,0	-	-	-	13,0 - 17,0	2,0 - 4,0	-	-	-	-	P 0,03	
TNi 6133-XY	ENiCrFe2Tx-y	Ni 6133	NiCr16Fe12NbMo	0,10	1,0 - 3,5	12,0	0,75	0,50	≥62,0	<0,10	-	-	13,0 - 17,0	0,5 - 3,0	0,5 - 2,5	-	-	-	P 0,03 S 0,02	
TNi 6182-XY	ENiCrFe3Tx-y	Ni 6182	NiCr15Fe6Mn	0,10	5,0 - 9,5	10,0	1,0	0,50	≥59,0	<0,10	-	1,0	13,0 - 17,0	1,0 - 2,5	-	-	-	-	P 0,03	
		Ni 6152	NiCr30Fe9Nb	0,05	5,0	7,0 - 12,0	0,8	0,50	≥50,0	-	0,5	0,5	28,0 - 31,5	1,0 - 2,5	0,5	-	-	-	-	
TNi 1013-xy	ENiMo13Tx-y			0,10	2,0-3,0	10,0	0,75	0,50	≥58,0	-	-	-	4,0-8,0	-	16,0-19,0	-	2,0-4,0	-	P 0,02 S 0,015	
Nickel-Chrome-Molybdenum																				
TNi 6002-XY	ENiCrMo2Tx-y	Ni 6002	NiCr22Fe18Mo	0,05 - 0,15	1,0	17,0 - 20,0	1,0	0,50	≥45,0	0,50-2,50	-	-	20,5 - 23,0	-	8,0-10,0	-	0,2 - 1,0	-	P 0,04 S 0,03	
		Ni 6012	NiCr22Mo9	0,03	1,0	3,5	0,7	0,50	≥58,0	-	0,4	0,4	20,0 - 23,0	1,5	8,5-10,5	-	-	-	-	
TNi 6022-XY	ENiCrMo10Tx-y	Ni 6022	NiCr21Mo13W3	0,02	1,0	2,0 - 6,0	0,2	0,50	≥49,0	2,5	-	-	20,0 - 22,5	-	12,5 - 14,5	0,35	2,5 - 3,5	-	P / S 0,03	
		Ni 6059	NiCr23Mo16	0,02	1,0	1,5	0,2	0,50	≥56,0	-	-	-	22,0 - 24,0	-	15,0 - 16,5	-	-	-	-	
		Ni 6275	NiCr15Mo16Fe5W3	0,10	1,0	4,0 - 7,0	1,0	0,50	≥50,0	-	-	-	14,5 - 16,5	-	15,0 - 18,0	0,4	-	-	-	
TNi 6276-XY	ENiCrMo4Tx-y	Ni 6276	NiCr15Mo15Fe6W4	0,02	1,0	4,0 - 7,0	0,2	0,50	≥50,0	2,5	-	-	14,5 - 16,5	-	15,0 - 17,0	0,35	3,0 - 4,5	-	P / S 0,03	
		Ni 6455	NiCr16Mo15Ti	0,02	1,5	3,0	0,2	0,50	≥56,0	-	-	0,7	14,0 - 18,0	-	14,0 - 17,0	-	0,5	-	-	
		Ni 6456	NiCr16Mo10Nb	0,10	5,0 - 8,0	10,0	0,8	0,50	≥58,0	-	-	1,0	15,0 - 18,0	1,5 - 3,0	9,0 - 11,0	-	-	-	-	
TNi 6625-XY	ENiCrMo3Tx-y	Ni 6625	NiCr22Mo9Nb	0,10	0,50	5,0	0,80	0,50	≥58,0	<0,10	-	0,40	20,0 - 23,0	3,15 - 4,15	8,0 - 10,0	-	-	-	-	
		Ni 6686	NiCr21Mo16W4	0,02	1,0	5,0	0,3	0,50	≥49,0	-	-	0,30	19,0 - 23,0	-	15,0-17,0	-	3,0 - 4,4	-	-	
Nickel-Chrome-Cobalt-Molybdenum																				
TNi 6117-XY	ENiCrCoMo1Tx-y	Ni 6117	NiCr22Co12Mo	0,05 - 0,15	2,5	0,50	0,75	0,50	≥45,0	9,0-15,0	-	-	21,0 - 26,0	1,0	8,0-10,0	-	-	-	P 0,03	
		Ni 6617	NiCr22Co12MoAlTi	0,05 - 0,15	2,5	0,50	0,75	0,50	≥45,0	-	1,5	0,6	21,0 - 26,0	1,0	8,0-10,0	-	-	-	-	
Z																				

## GUIDE TO AWS 5.34: NICKEL-ALLOY ELECTRODES FOR FLUX CORED ARC WELDING

AWS Classification		Tensile Strength, min.		Elongation <i>b</i> )
ISO Format	Traditional	psi	MPa	%, min.
TNi 6082-xy	ENiCr3Tx-y	80000	550	25
TNi 6062-xy	ENiCrFe1Tx-y			
TNi 6133-xy	ENiCrFe2Tx-y			
TNi 6182-xy	ENiCrFe3Tx-y			
TNi 6002-xy	ENiCrMo2Tx-y	90000	620	25
TNi 6625-xy	ENiCrMo3Tx-y	100000	690	25
TNi 6276-x	ENiCrMo4Tx-y			
TNi 6022-xy	ENiCrMo10Tx-y			
TNi 6117-xy	ENiCrCoMo1Tx-y			
TNi 6117-xy	ENiCrCoMo1Tx-y	90000	620	25

**NOTES:**  
a. As-welded condition.  
b. The elongation shall be determined from gage length equal to 4 times the gage diameter.



## GUIDE TO AWS A5.35: ELECTRODES FOR UNDERWATER WET SHIELDED METAL ARC WELDING

**Prologue:**

The welding electrodes covered by this specification utilize the following system to classify the welding electrodes:

- (1) Type of current
- (2) Filler metal type by general chemical composition
- (3) AWS classification of electrode by AWS specification, when applicable
- (4) Weld metal integrity (Y), based on soundness and mechanical properties
- (5) Welding position (Z)

**Electrode Classifications:**

Classification		Type of Current	General Filler Metal Chemical Composition
A5.35	5.35M		
UWE60XX-YZ	UWE43XX-YZ	Direct, electrode positive or negative	Ferritic steel
UWE70XX-YZ	UWE49XX-YZ	Direct, electrode positive or negative	Ferritic steel
UWE3XX-16-YZ	UWE3XX-16-YZ	Direct, electrode positive	Austenitic stainless steel
UWENiXX-YZ	UWENiXX-YZ	Direct, electrode positive	Nickel alloy

**Classification and Designators by Specification and Properties:**

Classification		Weld Metal Soundness/ Mechanical Property Level (Y) <sup>a</sup>	AWS-Spezification <sup>b</sup>
A5.35	5.35M		
UWE60XX-YZ	UWE43XX-YZ	1, 2 or 3	A5.1/A5.1M
UWE70XX-YZ	UWE49XX-YZ	1, 2 or 3	A5.1/A5.1M
UWE3XX-16-YZ	UWE3XX-16-YZ	1, 2 or 3	A5.4/A5.4M
UWENiXX-YZ	UWENiXX-YZ	1, 2 or 3	No applicable AWS Specification.

a Determine "Level" identification based on testing and examination results.

b Where an electrode (used on the surface, with no auxiliary coating) meets all the requirements of an applicable AWS specification and classification, including the chemical composition and mechanical property requirements, the "E" designation of the classification number shall indicate such (e.g., E6013 for AWS A5.1/A5.1M and E310 for AWS A5.4/A5.4M). Where an electrode does not conform to a particular AWS specification, the "E" designation shall show the primary alloy element followed by "XX" (e.g., ENiXX).

**Inspection Requirements<sup>a,b</sup>:**

Classification		Visual <sup>c</sup>	Magnetic Particle <sup>d</sup>	Liquid Penetrant <sup>e</sup>	Radiographic Test <sup>f</sup>
A5.35	5.35M				
UWE60XX-YZ	UWE43XX-YZ	Required	Required	NR	Required
UWE70XX-YZ	UWE49XX-YZ	Required	Required	NR	Required
UWE3XX-16-YZ	UWE3XX-16-YZ	Required	NR	Required	Required
UWENiXX-YZ	UWENiXX-YZ	Required	NR	Required	Required

a Test assembly shall be as shown in AWS

b NR = Not required.

c Visual testing procedures shall be as specified in AWS D3.6M.

d Magnetic particle testing procedures shall be in accordance with ASTM E709.

e Liquid penetrant testing procedures shall be in accordance with ASTM E165.

f Radiographic procedures shall be in accordance with ASTM E94.

**Testing Requirements<sup>a,b,c</sup> of All-Weld-Metal:**

Classification		Tension Test	Impact Test <sup>d</sup>	Chemical Analysis <sup>e</sup>
A5.35	5.35M			
UWE60XX-YZ	UWE43XX-YZ	Required	Required	Required
UWE70XX-YZ	UWE49XX-YZ	Required	Required	Required
UWE3XX-16-YZ	UWE3XX-16-YZ	Required	NR	Required
UWENiXX-YZ	UWENiXX-YZ	Required	NR	Required

a Test assembly shall be as shown in AWS

b See Clause 10 for additional testing requirements.

c NR = Not required.

d Testing procedures shall be in accordance with AWS B4.0 or AWS B4.0M and the applicable reference documents specified therein.

e Testing procedures shall be in accordance with ASTM E415, ASTM E353, ASTM E354, or other applicable ASTM standard.

## GUIDE TO AWS A5.35: ELECTRODES FOR UNDERWATER WET SHIELDED METAL ARC WELDING

### Examples of electrode classification.:

- (1) **UWE6013-2A**: Ferritic steel electrode (Table 1), similar to the E6013 classification of AWS A5.1, meeting the Level 2 quality standards, qualified for all position welding.
- (2) **UWE7014-1F**: Ferritic steel electrode (Table 1), similar to the E7014 classification of AWS A5.1, meeting the Level 1 quality standards, qualified for the flat position only.
- (3) **UWE310-16-3H**: Austenitic stainless steel electrode, similar to the E310-16 classification of AWS A5.4, meeting the Level 3 quality standards, qualified for flat and horizontal welding only.
- (4) **UWENiXX-1A**: Nickel electrode, meeting the Level 1 quality standards, qualified for all position welding.

### Example classification **CEWELD® AquaForce HR** according to AWS 5.35

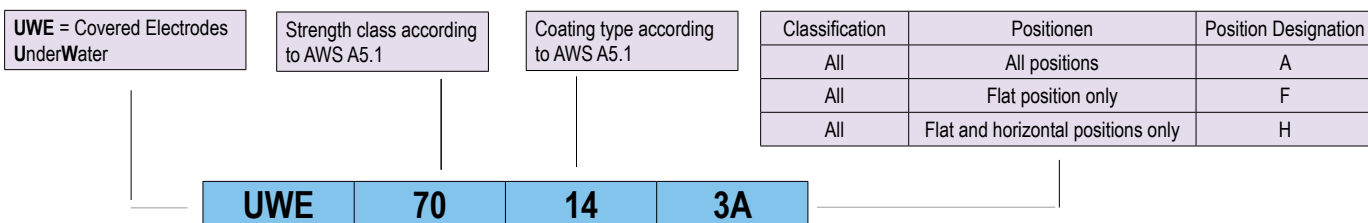

Evaluation Requirements For Level (Y) Designation	UWE60XX-YZ [UWE43XX-YZ]	UWE70XX-YZ [UWE49XX-YZ]	UWE3XX-16-YZ	UWENiXX-YZ
Chemical composition	1 )	1 )	1 )	1 )
Visual testing Level 1, 2, and 3	2 )	2 )	2 )	2 )
Magnetic particle testing Level 1, 2, and 3	MIL-STD-2035A Class 2	MIL-STD-2035A Class 2	Not applicable	Not applicable
Liquid penetrant testing Level 1, 2, and 3	Not required	Not required	MIL-STD-2035A Class 2	MIL-STD-2035A Class 2
Radiographic testing Level 1	MIL-STD-2035A Class 3	MIL-STD-2035A Class 3	MIL-STD-2035A Class 3	MIL-STD-2035A Class 3
Radiographic testing Level 2	3 )	3 )	3 )	3 )
Radiographic testing Level 3	AWS D3.6M Class B	AWS D3.6M Class B	AWS D3.6M Class B	AWS D3.6M Class B
Tensile strength (ksi [MPa]), min. Levels 1, 2, and 3	60 [430]	70 [490]	75 [520]	85 [590]
Yield Strength (ksi [MPa]), min. Level 1	48 [330]	51 [350]	50 [340]	65 [450]
Yield Strength (ksi [MPa]), min Level 2 / 3	46 [320]	46 [320]	Not required	Not required
Elongation (%) in 2 in [50 mm], min. Level 1	8	8	8	8
Elongation (%) in 2 in [50 mm], min. Level 2	6	6	6	6
Elongation (%) in 2 in [50 mm], min. Level 3	4	4	4	4
Reduction in area (%)	Report for information only	Report for information only	Report for information only	Report for information only
Average impact test (ft-lb bei 28F [-2°C]), min. Level 1	4 ) 30 ft-lbf.[50 Joule]	4 ) 30 ft-lbf.[50 Joule]	Not applicable	Not applicable
Average impact test (ft-lb bei 28F [-2°C]), min. Level 2	4 ) 25 ft-lbf.[40 Joule]	4 ) 25 ft-lbf.[40 Joule]	Not applicable	Not applicable
Average impact test (ft-lb bei 28F [-2°C]), min. Level 3	4 ) 15 ft-lbf.[20 Joule]	4 ) 15 ft-lbf.[20 Joule]	Not applicable	Not applicable

#### Notes:

- 1 Chemical composition shall meet the requirements of the applicable filler metal specification (for electrodes with no auxiliary coating).
- 2 Welds shall meet the visual acceptance criteria specified for AWS D3.6M Class B welds.
- 3 Weld shall meet the Class 3 requirements of MIL-STD-2035A, except porosity less than 1/16 in [1.5 mm] diameter may be disregarded.
- 4 Percent shear and lateral expansion shall be reported for information only.

## GUIDE TO AWS 5.36: SPECIFICATION FOR CARBON AND LOW-ALLOY STEEL FLUX CORED ELECTRODES FOR FLUX CORED ARC WELDING AND METAL CORED ELECTRODES FOR GAS METAL ARC WELDING

### Understanding A5.36

While not always easy to interpret, American Welding Society (AWS) specifications provide filler metal manufacturers with valuable information to guide the production of their welding wires and electrodes.

The A5.36 specification is an open classification for FCAW and MCAW wires that allows the products to bear additional classifications to indicate mechanical properties and usability, based on testing.

#### It combines:

[A5.20/A5.20M:2005 Carbon Steel Electrodes for Flux Cored Arc Welding](#)

[A5.29/A5.29M:2010 Specification for Low-Alloy Steel Electrodes for Flux Cored Arc Welding](#)

[A5.18/A5.18M:2017 Specification for Carbon Steel Electrodes and Rods for Gas Shielded Arc Welding](#)

[A5.28/A5.28M:2005 Specification for Low-Alloy Steel Electrodes for Low-Alloy Steel Electrodes and Rods for Gas Shielded Arc Welding](#)

#### So why has the A5.36 specification been developed?

#### And what does it mean to you?

#### A 5.36 open classification versus fixed classification

Traditionally, AWS prescribes fixed classifications for filler metals. This means a welding wire or electrode cannot be classified as offering any other mechanical properties than what have been determined within that classification. The only other options are designators that allow filler metal manufacturers to classify products with additional mechanical properties; however, these options are limited. For example, if a wire must meet a Charpy V-notch (CVN) impact toughness of 20 ft-lb. at -20 °F (or 20 ft-lb. at -40 °F with the addition of a J designator), then filler metal manufacturers can only classify it as that — even if changing shielding gas will improve its impact properties or the product is simply capable of achieving better properties.

Conversely, the **A5.36 is an open classification** for carbon and low-alloy flux-cored and metal-cored welding wires that allows the products to bear additional classifications to indicate mechanical properties and usability, based on testing. It was designed with two key benefits in mind:

- 1) To create flexibility in classifying filler metals to meet a wider range of application and marketplace requirements. The emergence of new base metal alloys requires welding wires and electrodes capable of meeting the materials' changing mechanical requirements — increased strengths and higher impact toughness, for example. The classification gives you more filler metal options to choose from for these applications.
- 2) To better define the performance capabilities of existing products. Filler metal manufacturers can showcase the full range of mechanical properties a product can provide after confirming it through testing. In the earlier example, a product may also offer impacts of 20 ft-lb. at -50 °F under A5.36.
  - 1) The introduction of new welding wire and electrode types for more applications In short, the A5.36 specification allows for:
  - 2) The use of greater selections of shielding gases
  - 3) More options for filler metal strength levels
  - 4) More flexibility with impact properties
  - 5) More flexibility with heat treatment conditions (e.g., as welded or post-weld heat treated)

**Note, the introduction of the A5.36 specification does not preclude the continuation of A5.20, A5.29, A5.18 or A5.28. These are popular specifications widely written into welding procedures and will continue to be used.**

## GUIDE TO EN AWS 5.36: SPECIFICATION FOR CARBON AND LOW-ALLOY STEEL FLUX CORED ELECTRODES FOR FLUX CORED ARC WELDING AND METAL CORED ELECTRODES FOR GAS METAL ARC WELDING

**The A5.36 specification utilizes distinct designators within its open classification system compared to a fixed AWS classification. Comparing the two can bring some clarity.**

**Consider an AWS E71T-1CJ H4 gas-shielded flux-cored (FCAW) carbon steel wire with a fixed classification under A5.20. The designators are as follows:**

- 1) E signifies the product is an electrode.
- 2) 70 indicates a tensile strength of 70 ksi.
- 3) 1 signifies the wire's capability to weld in all positions.
- 4) T means it's a tubular wire.
- 5) 1 signifies it is a gas-shielded rutile-based slag with good operating characteristics.
- 6) C means the wire requires 100 percent carbon dioxide shielding gas.
- 7) J designates a CVN toughness of 20 ft-lb. at -40 degrees Fahrenheit.
- 8) H4 shows the wire has 4ml of diffusible hydrogen per 100g of weldment.

**Under the A5.36 specification, the same wire could be classified as E71T-1-C1 A5-CS2-H4 or E71T-1-C1 P5-CS2-H4.**

Each of the designators shared with the fixed classifications remain the same. This wire can still offer 70 ksi tensile strength in all-positions using 100 percent carbon dioxide (indicated by C1 in the classification). Here's what's different:

- 1) A5 indicates the wire can offer CVN toughness of -20 ft-lb. at -50 °F in the as-welded condition.
- 2) P5 signifies it provides CVN toughness of -20 ft-lb. at -50 °F in the PWHT condition.
- 3) CS2 explains the weld deposit chemistry, which meets the lower Mn requirements of the A-No. 1 Analysis Group in the ASME, Boiler and Pressure Vessel Code, Section IX Welding and Brazing Qualification, QW-422.

Low-alloy products follow the same designators as a fixed classification for weld deposit chemistry, including Ni1, Ni2, K2 and K3.

**To add the A5.36 classification to a spec sheet or label for either carbon or low-alloy products, filler metal manufacturers must test their product to prove these mechanical properties.**

**Knowing a filler metal with an A5.36 open classification provides improved toughness potentially reduces the need to carry out additional qualification testing based on new materials and welding requirements.**

**The new open classification also aligns more closely with European standards for filler metals (e.g., ISO ).**

GUIDE TO AWS 5.36: SPECIFICATION FOR CARBON AND LOW-ALLOY STEEL FLUX CORED ELECTRODES FOR FLUX CORED ARC WELDING AND METAL CORED ELECTRODES FOR GAS METAL ARC WELDING

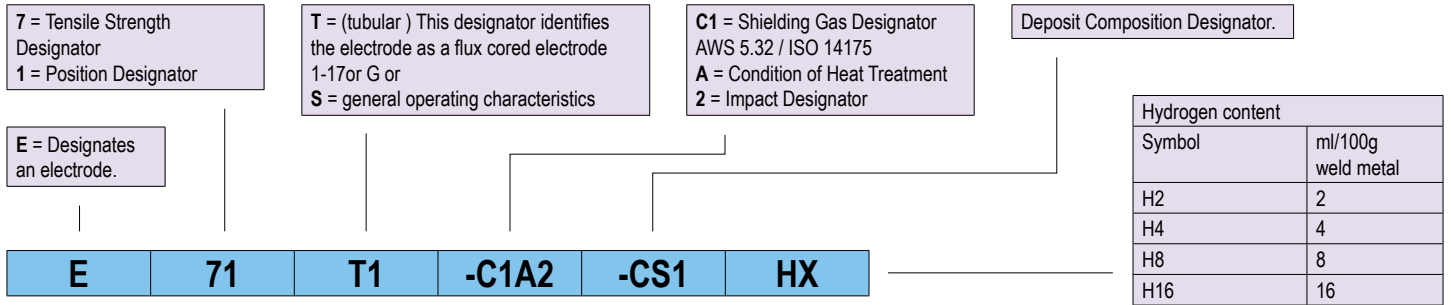

Tension Test Requirements								
Tensile Strength Designator		Single Pass Electrodes	For A5.36 Multiple Pass Electrodes U.S. Customary Units			For A5.36M Multiple Pass Electrodes International System of Units (SI)		
U.S. Customary Units	Int. System of Units (SI)	Minimum Tensile Strength ksi [MPa]	Tensile Strength (ksi)	Minimum Yield Strength a) (ksi)	Minimum % Elongation b)	Tensile Strength [MPa]	Minimum Yield Strengtha [MPa]	Minimum % Elongation b)
6	43	60 [430]	60-80	48	22	430-550	330	22
7	49	70 [490]	70-95 c	58	22	490-660 c	400	22
8	55	80 [550]	80-100	68	19	550-690	470	19
9	62	90 [620]	90-110	78	17	620-760	540	17
10	69	100 [690]	100-120	88	16	690-830	610	16
11	76	110 [760]	110-130	98	15 d	760-900	680	15 d
12	83	120 [830]	120-140	108	14 d	830-970	740	14 d
13	90	130 [900]	130-150	118	14 d	900-1040	810	14 d

- a) Yield strength at 0.2% offset.
- b) In 2 in [50 mm] gauge length when a 0.500 in [12.5 mm] nominal diameter tensile specimen and nominal gauge length to diameter ratio of 4:1 (as specified in the Tension Test section of AWS B4.0) is used. In 1 in [25 mm] gauge length when a 0.250 in [6.5 mm] nominal diameter tensile specimen is used as permitted for 0.045 in [1.2 mm] and smaller sizes of the E71T11-AZ-CS3 [E491T11-AZ-CS3].
- c) The maximum tensile strength shall be 90 ksi [620 MPa] for carbon steel electrodes with a T12 usability designator depositing a CS2 composition.
- d) Elongation requirement may be reduced by one percentage point if the tensile strength of the weld metal is in the upper 25% of the tensile strength range

Charpy Impact Test Requirements					
For A5.36 Multiple Pass Electrodes U.S. Customary Units °F			For A5.36M Multiple Pass Electrodes International System of Units (SI) °C		
Impact	Maximum	Minimum	Impact	Maximum	Minimum
Y	+68	20 ft·lbf	Y	20	27 Joules
0	0		0	0	
2	-20		2	-20	
4	-40		3	-30	
5	-50		4	-40	
6	-60		5	-50	
8	-80		6	-60	
10	-100		7	-70	
15	-150		10	-100	
Z	No Impact Requirements		Z	No Impact Requirements	
G	As agreed upon between the purchaser and supplier				

- a) Based on the results of the impact tests of the weld metal, the manufacturer shall insert in the classification the appropriate designator from Table 2 above, as indicated in Figure 1.
- b) When classifying an electrode to A5.36 using U.S. Customary Units the Impact Designator indicates the maximum impact test temperature in °F. When classifying to A5.36M using the International System of Units (SI) the Impact Designator indicates the maximum impact test temperature in °C. With the exception of the Impact Designator "4" a given Impact Designator will indicate different temperatures depending upon whether classification is according to A5.36 in U.S. Customary Units or according to A5.36M in the International System of Units (SI). For example, a "2" Impact Designator when classifying to A5.36 indicates a test temperature of -20°F. When classifying to A5.36M the "2" Impact Designator indicates a test temperature of -20°C, which is -4°F.
- c) Weld metal from an electrode that meets the impact requirements at a given temperature also meets the requirements at all higher temperatures in this Table. For example, weld metal meeting the A5.36 requirements for designator "5" also meets the requirements for designators 4, 2, 0 and Y. [Weld metal meeting the A5.36M requirements for designator "5" also meets the requirements for designators 4, 3, 2, 0 and Y].
- d) Filler metal classification testing to demonstrate conformance to a specified minimum acceptable level for impact testing, i.e., minimum energy at specified temperature, can be met by testing and meeting the minimum energy requirement at any lower temperature. In these cases, the actual temperature used for testing shall be listed on the certification documentation when issued.

## GUIDE TO EN AWS 5.36: SPECIFICATION FOR CARBON AND LOW-ALLOY STEEL FLUX CORED ELECTRODES FOR FLUX CORED ARC WELDING AND METAL CORED ELECTRODES FOR GAS METAL ARC WELDING

<b>E</b>	<b>71</b>	<b>T1</b>	<b>-C1A2</b>	<b>-CS1</b>	<b>HX</b>
----------	-----------	-----------	--------------	-------------	-----------

Usability Designators and General Description of Electrode Types				
Electrode a) Usability Designator	Prozess b)	Polung c)	Position d) e)	Description f)
<b>T1</b>	FCAW-G	DCEP	H, F, VU & OH	Flux cored electrodes of this type are gas shielded and have a rutile base slag. They are characterized by a spray transfer, low spatter loss, and a moderate volume of slag which completely covers the weld bead
<b>T1S</b>	FCAW-G	DCEP	H, F, VU & OH	Flux cored electrodes of this type are similar to the "T1" type electrodes but with higher manganese or silicon, or both. They are designed primarily for single pass welding in the flat and horizontal positions. The higher levels of deoxidizers in this electrode type allow single pass welding of heavily oxidized or rimmed steel.
<b>T3S</b>	FCAW-S	DCEP	H & F	Flux cored electrodes of this type are self-shielded and are intended for single pass welding and are characterized by a spray type transfer. The titanium-based slag system is designed to make very high welding speeds possible
<b>T4</b>	FCAW-S	DCEP	H & F	Flux cored electrodes of this type are self-shielded and are characterized by a globular type transfer. Its fluoride-based basic slag system is designed to make very high deposition rates possible and to produce very low sulfur welds for improved resistance to hot cracking.
<b>T5</b>	FCAW-G	DCEP or DCEN g	H, F, VU & OH	Flux cored electrodes of this type are gas shielded and are characterized by a globular transfer, slightly convex bead contour, and a thin slag that may not completely cover the weld bead. They have a lime-fluoride slag system and develop improved impact properties and better cold cracking resistance than typically exhibited by the "T1" type electrodes.
<b>T6</b>	FCAW-S	DCEP	H & F	Flux cored electrodes of this type are self-shielded and are characterized by a spray transfer. Its oxide-based slag system is designed to produce good low temperature impacts, good penetration into the root of the weld and excellent slag removal.
<b>T7</b>	FCAW-S	DCEN	H, F, VU & OH	Flux cored electrodes of this type are self-shielded and are characterized by a small droplet to spray type transfer. The fluoridebased slag system is designed to provide high deposition rates in the downhand positions with the larger diameters and out of position capabilities with the smaller diameters.
<b>T8</b>	FCAW-S	DCEN	H, F, VU, VD & OH	Flux cored electrodes of this type are self-shielded and are characterized by a small droplet to spray type transfer. The fluoridebased slag system is designed to provide improved out-of-position control. The weld metal produced typically exhibits very good low temperature notch toughness and crack resistance
<b>T10S</b>	FCAW-S	DCEN	H & F	Flux cored electrodes of this type are self-shielded and are characterized by a small droplet transfer. The fluoride-based slag system is designed to make single pass welds at high travel speeds on steel of any thickness
<b>T11</b>	FCAW-S	DCEN	H, F, VD & OH	Flux cored electrodes of this type are self-shielded and are characterized by a smooth spray type transfer, limited slag coverage and are generally not recommended for the welding of materials over 3/4 in [20 mm] thick.
<b>T12</b>	FCAW-G	DCEP	H, F, VU & OH	Flux cored electrodes of this type are similar in design and application to the T1 types. However, they have been modified for improved impact toughness and to meet the lower manganese requirements of the A-No 1 Analysis Group in the ASME Boiler and Pressure Vessel Code, Section IX conforming to the CS2 weld deposit.
<b>T14S</b>	FCAW-S	DCEN	H, F, VD & OH	Flux cored electrodes of this type are self-shielded and are characterized by a smooth spray type transfer. The slag system is designed for single pass welds in all positions and at high travel speeds.
<b>T15</b>	GMAW-C	DCEP or DCEN	H, F, VU, VD & OH	Electrodes of this type are gas shielded composite stranded or metal cored electrodes. The core ingredients are primarily metallic. The non-metallic components in the core typically total less than 1% of the total electrode weight. These electrodes are characterized by a spray arc and excellent bead wash capabilities. Applications are similar in many ways to solid GMAW electrodes.
<b>T16</b>	GMAW-C	ACh	H, F, VU, VD & OH	This electrode type is a gas shielded metal cored electrode specifically designed for use with AC power sources with or without modified waveforms
<b>T17</b>	FCAW-S	ACh	H, F, VU, VD & OH	This flux cored electrode type is a self-shielded electrode specifically designed for use with AC power sources with or without modified waveforms.
<b>TG or TGS</b>	Wie zwischen dem Käufer und dem Lieferanten vereinbart.			

- a) An "S" is added to the end of the usability designator when the electrode being classified is intended for single pass applications only. See Figure 1.
- b) Properties of weld metal from electrodes that are used with external shielding gas will vary according to the shielding gas used. Electrodes classified with a specific shielding gas should not be used with other shielding gases without first consulting the manufacturer of the electrode.
- c) The term "DCEP" refers to direct current electrode positive (dc, reverse polarity). The term "DCEN" refers to direct current electrode negative (dc, straight polarity). The term "AC" refers to alternating current.
- d) H = horizontal position, F = flat position, OH = overhead position, VU = vertical position with upward progression, and VD = vertical position with downward progression.
- e) Electrode sizes suitability for out-of-position welding, i.e., welding positions other than flat and horizontal, are usually those sizes that are smaller than 3/32 in [2.4 mm] size or the nearest size called for in Clause 9 for the groove weld. For that reason, electrodes meeting the requirements for the groove weld tests may be classified as EX1T1X-XXX-X with the "1" usability designator regardless of their size.
- f) For more information, refer to Clauses B7 and B8 in Annex B.
- g) Some EX1T5-XXX-X electrodes may be recommended for use on DCEN for improved out-of-position welding. Consult the manufacturer.
- h) For this electrode type, the welding current can be conventional sinusoidal alternating current, a modified AC waveform between positive and negative, an alternating DCEP waveform, or an alternating DCEN waveform.



## GUIDE TO EN AWS 5.36: SPECIFICATION FOR CARBON AND LOW-ALLOY STEEL FLUX CORED ELECTRODES FOR FLUX CORED ARC WELDING AND METAL CORED ELECTRODES FOR GAS METAL ARC WELDING

E	71	T1	-C1A2	-CS1	HX
---	----	----	-------	------	----

AWS Classification	Chemical composition % a)											
	C	Mn	Si	P	S	Ni	Cr	Mo	V	Al	Cu	Other
<b>Carbon Steel Electrodes</b>												
CS1e	0.12	1.75	0.90	0,030	0,030	0.50 f	0.20 f	0.30 f	0.08 f	-	0.35 f	-
CS2 e, g	0.12	1.60	0.90	0,030	0,030	0.50 f	0.20 f	0.30 f	0.08 f	-	0.35 f	-
CS3 e	0.30	1.75	0.60	0,030	0,030	0.50 f	0.20 f	0.30 f	0.08 f	1.8 f, h	0.35 f	-
<b>Carbon-Molybdenum Steel Electrodes</b>												
A1	0.12	1,25	0,80	0,030	0,030	-	-	0,40-0,65	-	-	-	-
<b>Chromium-Molybdenum Steel Electrodes</b>												
B1	0,05-0,12	1,25	0,80	0,030	0,030	-	0,40-0,65	0,40-0,65	-	-	-	-
B1L	0,05	1,25	0,80	0,030	0,030	-	0,40-0,65	0,40-0,65	-	-	-	-
B2	0,05-0,12	1,25	0,80	0,030	0,030	-	1,00-1,50	0,40-0,65	-	-	-	-
B2L	0,05	1,25	0,80	0,030	0,030	-	1,00-1,50	0,40-0,65	-	-	-	-
B2H	0,10-0,15	1,25	0,80	0,030	0,030	-	1,00-1,50	0,40-0,65	-	-	-	-
B3	0,05-0,12	1,25	0,80	0,030	0,030	-	2,00-2,50	0,90-1,20	-	-	-	-
B3L	0,05	1,25	0,80	0,030	0,030	-	2,00-2,50	0,90-1,20	-	-	-	-
B3H	0,10-0,15	1,25	0,80	0,030	0,030	-	2,00-2,50	0,90-1,20	-	-	-	-
B6	0,05-0,12	1,25	1,00	0,030	0,040	0,40	4,0-6,0	0,40-0,65	-	-	0,50	-
B6L	0,05	1,25	1,00	0,030	0,040	0,40	4,0-6,0	0,40-0,65	-	-	0,50	-
B8	0,05-0,12	1,25	1,00	0,030	0,040	0,40	8,0-10,5	0,85-1,20	-	-	0,50	-
B8L	0,05	1,25	1,00	0,030	0,030	0,40	8,0-10,5	0,85-1,20	-	-	0,50	-
B91i	0,08-0,13	1,20 j	0,50	0,015	0,020	0,80 j	8,0-10,5	0,85-1,20	0,15-0,30	0,04	0,25	Nb: 0.02-0.10 N: 0.02-0.07
B92	0,08-0,15	1,20 j	0,50	0,015	0,020	0,80 j	8,0-10,0	0,30-0,70	0,15-0,30	0,04	0,25	Nb: 0.02-0.08 W: 1.5-2.0 B: 0.006 N: 0.02-0.08 Co k
<b>Nickel Steel Electrodes</b>												
Ni1	0,12	1,50	0,80	0,030	0,030	0,80-1,10	0,15	0,35	0,05	1,8 h	-	-
Ni2	0,12	1,50	0,80	0,030	0,030	1,75-2,75	-	-	-	1,8 h	-	-
Ni3	0,12	1,50	0,80	0,030	0,030	2,75-3,75	-	-	-	1,8 h	-	-
<b>Manganese-Molybdenum Steel Electrodes</b>												
D1	0,12	1,25-2,00	0,80	0,030	0,030	-	-	0,25-0,55	-	-	-	-
D2	0,15	1,65-2,25	0,80	0,030	0,030	-	-	0,25-0,55	-	-	-	-
D3	0,12	1,00-1,75	0,80	0,030	0,030	-	-	0,40-0,65	-	-	-	-
<b>Other Low-Alloy Steel Electrodes and Rods</b>												
K1	0,15	0,80-1,40	0,80	0,030	0,030	0,80-1,10	0,15	0,20-0,65	0,05	-	-	-
K2	0,15	0,50-1,75	0,80	0,030	0,030	1,00-2,00	0,15	0,35	0,05	1,8 h	-	-
K3	0,15	0,75-2,25	0,80	0,030	0,030	1,25-2,60	0,15	0,25-0,65	0,05	-	-	-
K4	0,15	1,20-2,25	0,80	0,030	0,030	1,25-2,60	0,20-0,60	0,20-0,65	0,03	-	-	-
K5	0,10-0,25	0,60-1,60	0,80	0,030	0,030	0,75-2,00	0,20-0,70	0,15-0,55	0,05	-	-	-
K6	0,15	0,50-1,50	0,80	0,030	0,030	0,40-1,00	0,20	0,15	0,05	1,8 h	-	-
K7	0,15	1,00-1,75	0,80	0,030	0,030	2,00-2,75	-	-	-	-	-	-
K8	0,15	1,00-2,00	0,40	0,030	0,030	0,50-1,50	0,20	0,20	0,05	1,8 h	-	-
K9	0,07	0,50-1,50	0,60	0,015	0,015	1,30-3,75	0,20	0,50	0,05	-	0,06	-
K10	0,12	1,25-2,25	0,80	0,030	0,030	1,75-2,75	0,20	0,05	-	-	0,05	-
K11	0,15	1,00-2,50	0,80	0,030	0,030	0,40-1,00	0,20	0,05	0,05	1,8 h	-	-
K12	0,15	1,50-2,75	0,80	0,030	0,030	0,75-2,00	0,20	0,05	0,05	1,8 h	-	-
K13	0,15	1,00	0,80	0,030	0,030	1,00-2,00	0,15	0,35	0,05	1,8 h	-	-
W2	0,12	0,50-1,30	0,35-0,80	0,030	0,030	0,40-0,80	0,45-0,70	-	-	-	0,30-0,75	-
G / GS m	G see Note i		As agreed upon between the purchaser and supplier									

a) The weld metal shall be analyzed for the specific elements for which values are shown in this table.

b) Refer to ASTM DS-56/SAE HS-1086, Metals & Alloys in the Unified Numbering System. An "X," when present in the last position, represents the usability designator for the electrode type used to deposit the weld metal. An exception to this applies to the "11" electrode type where a "9" is used instead of an "11."

c) Single values are maximum.

d) An analysis of the weld deposit for boron is required and shall be reported if this element is intentionally added or if it is known to be present at levels in excess of 0.0010%.

e) The total of all the elements listed in this table for this classification shall not exceed 5%.

f) The analysis of these elements shall be reported only if intentionally added.

g) Meets the lower Mn requirements of the A-No. 1 Analysis Group in the ASME, Boiler and Pressure Vessel Code, Section IX Welding and Brazing Qualifications, QW-422.

h) Applicable to self-shielded electrodes only. Electrodes intended for use with gas shielding normally do not have significant additions of aluminum.

i) The "B91" designation replaces the "B9" designation previously used for this alloy type.

j) Mn + Ni = 1.40% maximum (see B8.2 in Annex B). Some applications may require lower limits on the Mn + Ni content. Provisions are made in this document to indicate conformance to lower limits for the Mn + Ni content through the use of supplemental designators. See A6 in Annex A.

k) Analysis for Co is required to be reported if intentionally added, or if it is known to be present at levels greater than 0.20%.

l) The limit for gas shielded electrodes is 0.18% maximum. The limit for self-shielded electrodes is 0.30% maximum.

m) The composition of weld metal is not particularly meaningful since electrodes in this category are intended only for single pass welds. Dilution from the base metal in such welds is usually quite high. See B7.2 in Annex B.



## AWS FILLER METAL SPECIFICATIONS BY MATERIAL AND WELDING PROCESS

	OFW	SMAW	GTAW GMAW MCAW PAW	FCAW	SAW	ESW	EGW	Brazing (B)
<b>Carbon Steel</b>	A5.2	A5.1, A5.35	A5.18, A5.36	A5.20, 5.36	A5.17	A5.25	A5.26	A5.8, A5.31
<b>Low-Alloy Steel</b>	A5.2	A5.5	A5.28, A5.36	A5.29, A5.36	A5.23	A5.25	A5.26	A5.8, A5.31
<b>Stainless Steel</b>		A5.4, A5.35	A5.9, A5.22	A5.22	A5.9	A5.9	A5.9	A5.8, A5.31
<b>Cast Iron</b>	A5.15	A5.15	A5.15	A5.15				A5.8, A5.31
<b>Nickel Alloys</b>		A5.11, A5.35	A5.14	A5.34	A5.14	A5.14		A5.8, A5.31
<b>Aluminum Alloys</b>		A5.3	A5.10					A5.8, A5.31
<b>Copper Alloys</b>		A5.6	A5.7					A5.8, A5.31
<b>Titanium Alloys</b>			A5.16					A5.8, A5.31
<b>Zirconium Alloys</b>			A5.24					A5.8, A5.31
<b>Magnesium Alloys</b>			A5.19					A5.8, A5.31
<b>Tungsten Electrodes</b>			A5.12					
<b>Brazing Alloys and Fluxes</b>								A5.8, A5.31
<b>Surfacing Alloys</b>	A5.21		A5.21	A5.21	A5.21			
<b>Consumable Inserts</b>			A5.30					
<b>Shielding Gases</b>			A5.32	A5.32			A5.32	

## TYPES OF TEST CERTIFICATES ACCORDING TO EN 10204: 2004 AVAILABLE WITH THE CERTILAS WELDING CONSUMABLES

The EN 10204 standard describes the different types of test certificates that the Orderer in accordance with the agreements when ordering for the delivery of metallic products, such as steel plate or welding consumables can be made available.

The following types of test certificates can be issued:

Type of test certificate		Designation of the document type	Document validated by
2.1	Declaration of compliance with the order	Statement of compliance with the order	The manufactures (Can be an employee sales)
2.2	Factory certificate	Statement of compliance with the order, with indication of results non specific inspection <b>Statistical values according to catalog</b>	Die Hersteller (Kann ein Mitarbeiter aus dem Verkauf sein)
3.1 / 2.2 Hybrid	Test certificate that does not actually exist according to standard but is often presented on the market as 3.1	Statement of compliance with the order, with indication of results non specific inspection <b>3.1 Actual analysis elements specially determined for this batch</b> <b>2.2 Statistical values according to catalog</b>	The manufactures (Can be an employee sales)
3.1	Inspection certificate 3.1	Statement of compliance with the order, with indication of results of specific inspection <b>All values are values of this lot specifically identified</b>	The manufactures authorized inspection representee independent of the manufacturing department ( <b>employee QM</b> )
3.2	Inspection certificate 3.2	Statement of compliance with the order, with indication of results of specific inspection All values are values of this batch specifically determined in the presence of an external tester has been welded and later checked (batch registration)	The manufactures authorized inspection representative independent of the manufacturing department and either the purchaser's authorized inspection representative or the inspector designated by the official regulations ( <b>Employees QM and external auditors</b> )

### NOTE:

**Solid wire products:** Chemical analysis of the specific wire batch, together with typical mechanical properties based on annual testing statistics.

**Coated electrodes:** Low alloyed and stainless steel. All-weld metal chemical analysis of the specific batch, together with typical mechanical properties based on annual testing.

**Cored wires:** All-weld metal chemical analysis and mechanical properties of the specific batch. Standard inspection documents are free of charge, but must be clearly specified on the order.

**Special certificates:** In addition to the above inspection documents, it is possible to receive certificates showing extended batch testing according to customer requirements, but these must be clearly specified in advance on the order and will be charged according to current CERTILAS- laboratory testing fees.

**Preparation of the weld metal:**

GMAW, MCAW, FCAW according to 1.3 ISO 15792

SAW according to 1.3 for Part A for Part B 1.3 and 1.4 ISO 15792 possible

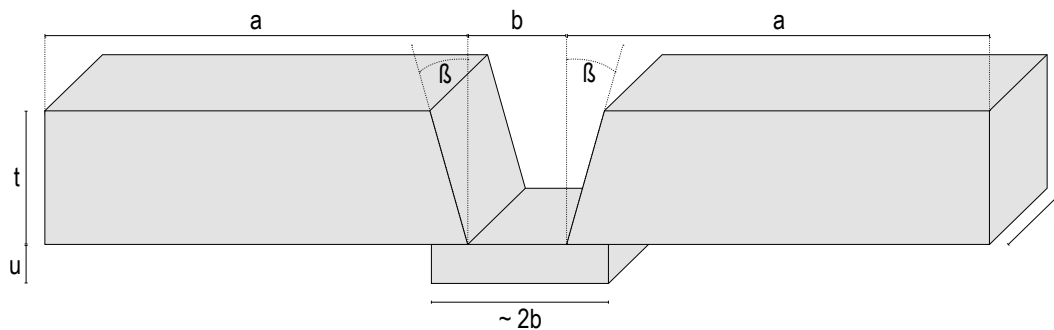

Type	t	a	b	u	β	l
1.0	12	> 80	10	> 6	10 +2,5 - 0	> 150
1.1	12	> 90	12			
1.2	16	> 100	14			
1.3	20	> 150	16			
1.4	25	> 150	20			
1.5	30	> 200	25			
1.6	20	> 150	20			
1.7	25	> 150	24			

**Welding parameters / Pass and layer sequence according ISO for GMAW, MCAW, FCAW**

Ø	Passes per layer		Gesamtzahl der Lagen
	First layer	Other layers	
0,8 0,9	1 or 2	2 or 3	6 to 9
1,0 1,2	1 or 2	2 or 3	6 to 9
1,4 1,6	1 or 2	2 or 3	5 to 8
2,0	1 or 2	2 or 3	5 to 8
2,4	1 or 2	2 or 3	4 to 8
2,8	1 or 2	2 or 3	4 to 7
3,2	1 or 2	2	4 to 7
4,0	1	2	4 to 7

Ø	Ø kJ/mm	Passes per layer		Numbers of layers
		First layer	Other layers	
0,8 0,9	0,8 - 1,6	1 or 2	2 or 3	6 to 9
1,0 1,2	1,2 - 2,0	1 or 2	2 or 3	6 to 9
1,4 1,6	1,4 - 2,2	1 or 2	2 or 3	5 to 8
2,0	1,8 - 2,4	1 or 2	2 or 3	5 to 8
2,4	2,0 - 2,6	1 or 2	2 or 3	4 to 8
2,8	2,0 - 2,8	1 or 2	2 or 3	4 to 7
3,2	2,2 - 3,0	1 or 2	2	4 to 7
4,0	2,6 - 3,3	1	2	4 to 7

**Example of wire diameter 0.8-1.2 mm:**

**Min. 12 weld beads  
Max. 27 weld beads**

**We recommend:  
Yield strengths < 550 MPa  
18 -24 weld bead**

**For higher strength:  
Yield strengths > 550 MPa  
24-27 weld bead**

## Welding parameters / Pass and layer sequence according ISO for SAW

Welding conditions for multi-run single solid wire welding (classification by yield strength and 47 J impact energy)				
Conditions	Solid wire electrode Ø mm		Tubular cored electrode Ø mm	
		2,8 - 3,2	4,0	3,0 - 3,2
Type of Ccurrent	Direct current			
Length of weld deposit, mm	≥ 350			
Welding current, A	440 ± 20	580 ± 20	480 ± 20	550 ± 20
Welding voltage, V	27 ± 2	29 ± 2	30 ± 2	
Welding speed, mm/min	400 ± 50	550 ± 50	450 ± 50	
Interpass temperature range °C (no preheat)	150 ± 25			
Electrode extension, mm	30 ± 5			
- AC or DC, either polarity, may be used. The reference method shall be as recommended by the manufacturer.				
- Diameters not specified are to be welded following the recommendations of the electrode manufacturer.				

Welding conditions for multi-run single solid wire welding (classification by tensile strength and 27 J impact energy)						
Conditions	3,2	4	4,8	3,2	4	4,8
	Type of Ccurrent	Direct current			Alternating current	
Length of weld deposit, mm	≥ 200			≥ 200		
Welding current, A	450 ± 50	500 ± 50	600 ± 50	450 ± 50	500 ± 50	600 ± 50
Welding voltage, V	28 ± 2	30 ± 2	32 ± 2	30 ± 2	32 ± 2	34 ± 2
Welding speed, mm/min	350 ± 20	400 ± 20	450 ± 20	350 ± 20	400 ± 20	450 ± 20
Preheat temperature °C	b)	Room temperature			Room temperature	
	c)	≥ 100			≥ 100	
Interpass temperature °C	150 ± 15			150 ± 15		
Electrode extension, mm	30 ± 5			30 ± 5		
- AC or DC, either polarity, may be used. The reference method shall be as recommended by the manufacturer						
- b) for SU0, SU11, SU12, SU21, SU22, SU23, SU24, SU25, SU31, SU32, SU33, SU41, SU42, SU51						
- c) for other symbols except b)						

Weld metal test specimens according to AWS 5.17/23/22 and (18/20/28/29) = SFA-5.36

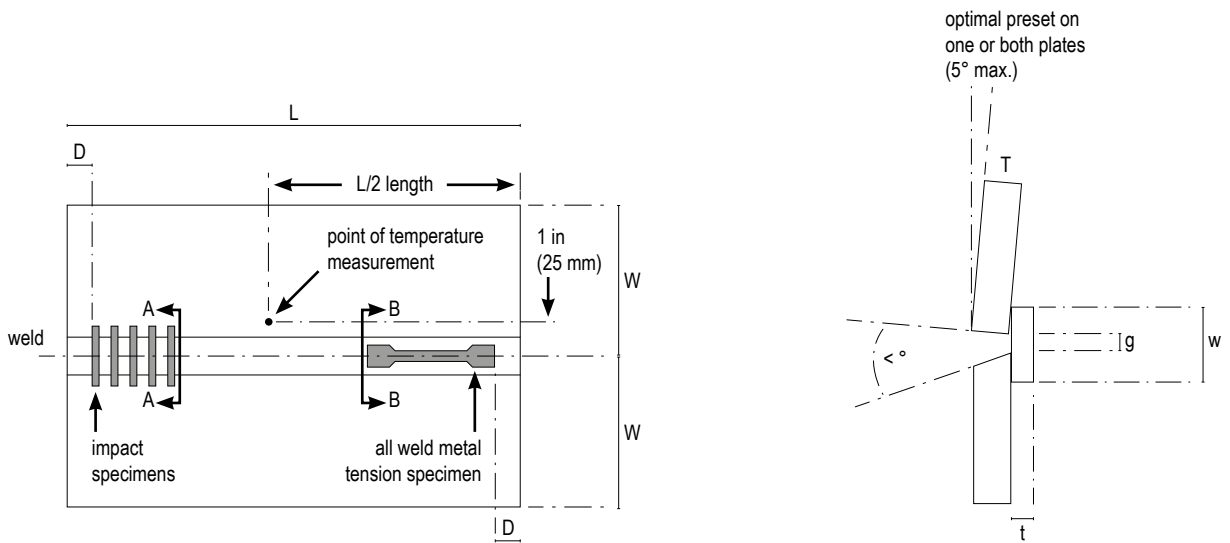

(A) test plate showing location of test specimens

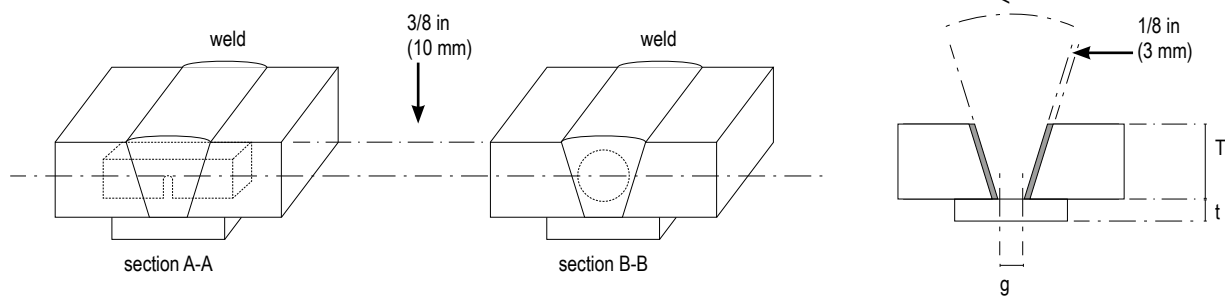

(B) orientation of impact specimen

(C) location of all-weld-metal tension specimen

(D) buttered test plate

AWS	L	W	T	D	$\alpha^\circ$	g	w	t	M
5.17	12 in 305 mm	5 in 127 mm	$1 \pm 1/16$ in $25 \pm 1,5$ mm	1 in 25 mm	$30^\circ$	$1/2 - 0$ in, $1/16$ in $12-0$ mm, + 1 mm	2 in 50 mm	$1/2$ in 13 mm	
5.18/20/28/29	10 in 250 mm	6 in 150 mm	$3/4 \pm 1/32$ in $20 \pm 1$ mm	1 in 25 mm	$45^\circ \pm 2^\circ$	$1/2 - 0$ in, $1/16$ in $12-0$ mm, + 1 mm	ca. 2 g	$1/4$ in 6 mm	$1/8$ in 3 mm
5.22	10 in 250 mm	min 5 in min 127 mm	$1/2 - 3/4$ in 12,7 - 20 mm	1 in 25 mm	$45^\circ \pm 5^\circ$	$3/8$ in ( $1/4$ in) 9,5 mm (6.4 mm)	1 in 25 mm	min $1/4$ in min 6 mm	2 layer

**Weld metal test specimens according to AWS 5.17/18/20/28/29 = SFA-5.36**

Heat input requirements and suggested pass and layer sequence for multiple pas electrode classifications						
Ø		Required average heat input		Suggested passes per layer		Suggested number of layers
in	mm	kJ / in	kJ / mm	Layer 1	Layer 2 to top	
≤ 0,030 0,035	≤ 0,8 0,9	20 - 35	0,8 - 1,4	1 or 2	2 or 3	6 - 9
- 0,045 -	1,0 - 1,2	25 - 50	1,0 - 2,0	1 or 2	2 or 3	6 - 9
0,052 - 1/16	- 1,4 1,6	25 - 55	1,0 - 2,2	1 or 2	2 or 3	5 - 8
0,068 - 0,072 5/64(0,078)	- 1,8 - 2,0	35 - 65	1,4 - 2,6	1 or 2	2 or 3	5 - 8
3/32 (0,094)	2,4	40 - 65	1,6 - 2,6	1 or 2	2 or 3	4 - 8
7/6 (0,109)	2,8	50 - 70	2,0 - 2,8	1 or 2	2 or 3	4 - 7
0,120 1/8 (0,125)	- 3,2	55 - 75	2,2 - 3,0	1 or 2	2	4 - 7
5/32 (0,156)	4,0	65 - 85	2,6 - 3,3	1	2	4 - 7

**Example of wire  
diameter 0.8-1.2 mm:**

**Min. 11 weld beads  
Max. 26 weld beads**

**We recommend:  
Yield strengths < 550 MPa  
18 -24 weld beads**

**For higher strength:  
Yield strengths > 600 MPa  
24-26 weld beads**

## MECHANICAL TESTING OF WELD METAL

Test plate preparation and specimen location for all-weld metal testing is shown in the figure below. Two types of test specimens are prepared – cylindrical test pieces for tensile testing and square Charpy V-Notch test pieces for impact energy testing.

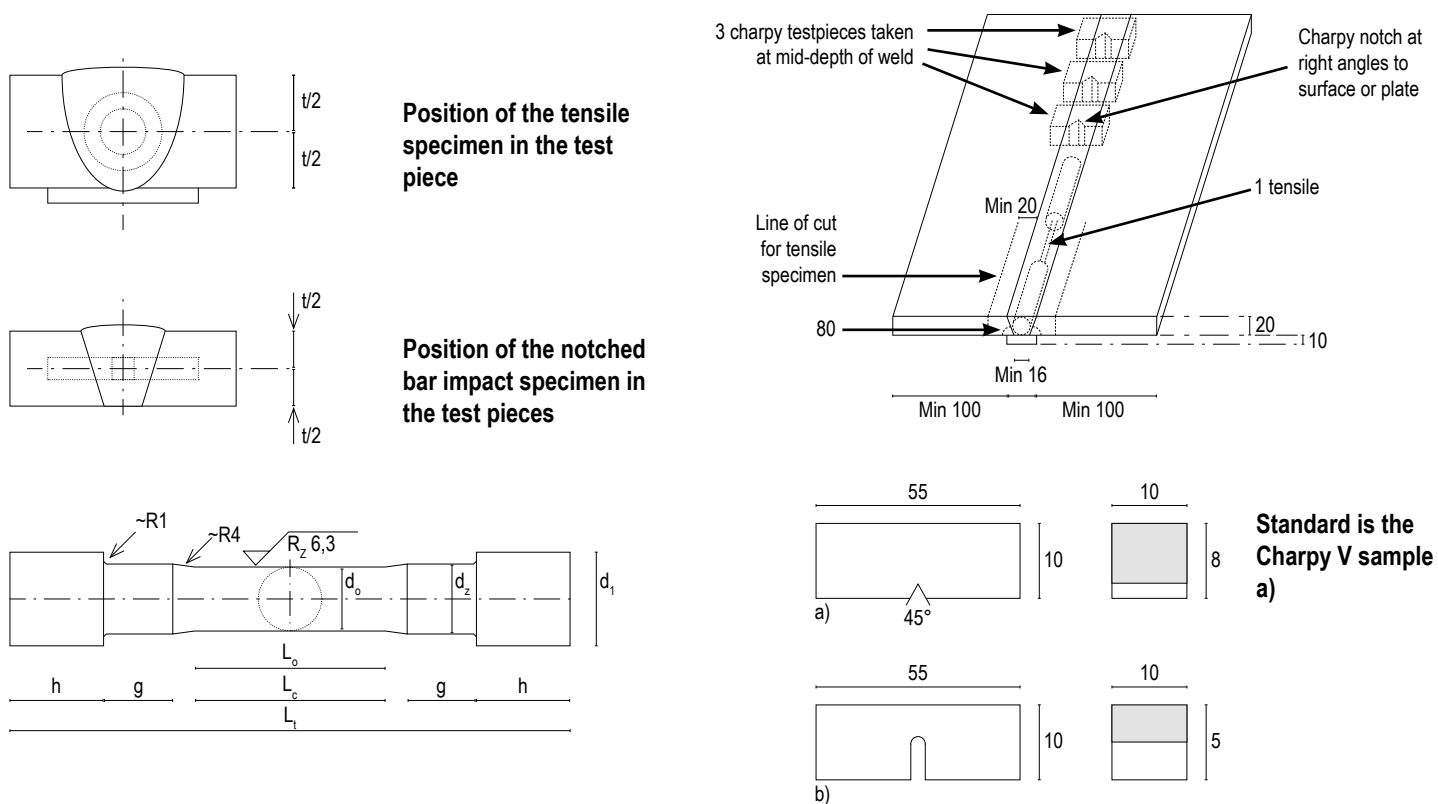

### Yield Strength

Yield strength is the applied stress (load) at which the material under test begins to yield plastically and produce permanent deformation after the load is removed.

Soft and carbon-manganese filler metals have a clear transition point between elastic and plastic deformation, and the yield strength is indicated by the symbol  $R_e$  and measured in units of MPa. There is a limit called Lower  $R_{eL}$  and an High  $R_{eH}$ . Other welding consumables, such as stainless steel, do not exhibit the same well-defined transition limit and in these cases the yield strength is defined as the point at which a specified permanent deformation remains in the specimen after the load has been removed. In the standard, these refer to -a residual deformation of 0.2% and are then denoted  $R_p 0.2\%$ .

### Tensile Strength

This is the maximum stress which the material under test can be subjected to before fracture occurs and is designated  $R_m$  and measured in units of MPa.

### Elongation

This is a measurement of the weld metal's ability to deform before fracture occurs. It is designated  $A_5$  and measured as a percentage of the original test specimen length, which is normally five times the specimen diameter.

### Impact energy (fracture toughness)

The notched bar impact energy is used to determine the toughness of the weld metal at a specific temperature under impact loading and is a measure of the material's resistance to brittle fracture. Notched bar impact energy is determined with a V-notch test specimen using the Charpy-V method and is measured in units of joules (J).

As a further form, there is also the U-notch. Fracture toughness values are temperature dependent and decrease with decreasing temperature. In general, a weld metal is „safe“ against brittle fracture up to the temperature that results in a minimum impact energy value of 47 joules according to the ISO standard. AWS usually 27J and for some approval companies 10% of the yield strength in joules.



### CONSUMABLES COATED ELECTRODES

Store electrodes always in original (re) closable cans and reclose the can after taking out the electrodes. Vacuum packed electrodes can be used for approximately 6 hours after opening the packaging without re-drying, the atmospheric conditions must be  $\leq 35^\circ\text{C}$  and  $\leq 90\% \text{RH}$ . When electrodes out of the original packaging are exposed for more than 10 hours to an atmosphere with relative humidity of  $\geq 60\%$ , re-drying is recommended. For electrodes with a yield  $\geq 460 \text{ MPa}$  the recommendation is a maximum of 3 times re-drying.

### SOLID-, SEAMLESS FLUX-CORED WIRE AND STRIP

Store wire always in the undamaged original packaging. We recommend especially for aluminum wires to acclimatize them for 24 hours in the workshop. Solid-, seamless flux-cored wires and strip don't need re-drying.

Seamless flux- and metal-cored wires are totally insensitive to moisture absorption and can be stored for a 24 months' period. Like solid wire, however, they are copper-coated and direct contact with any liquid - particularly water - must be avoided to prevent the formation of rust on the wire surface. Rust is a potential source of weld metal hydrogen, but it can also cause poor wire feeding.

It is therefore recommended:

- to store wires in a dry area
- away from weather influences
- and in their original packaging
- any sudden drop in temperature should be avoided
- avoided to prevent the formation of condensate water.

It is sufficient to slightly warm the storeroom during winter months. Partly used wire spools must be re-packed in their original plastic bag, carefully sealed, and stored in their original cardboard boxes.

### FOLDED FLUX-CORED WIRE

Store wire always in the undamaged original packaging. When there are big temperature differences between night and day, recommendation is to keep the spool not on the machine at night, but to store the spool in a room where the temperature is above the dew point.

### SAW AND ESW FLUXES

Store fluxes always in undamaged and unopened original steel can or bag. Keep fluxes away from water, oil and grease products. Unprotected fluxes must, after 12 hours use, be re-dried in a drying oven. Recycling: Moisture, oil and grease must be removed from the compressed air used for the recycling system. Addition of new flux must be done with the proportion of at least one part new flux on three parts recycled flux. Re-drying: Agglomerated fluxes 2-4 hours at  $300^\circ\text{C} \pm 25^\circ\text{C}$  Fused fluxes 2-4 hours at  $200^\circ\text{C} \pm 50^\circ\text{C}$ .

### GENERAL RECOMMENDATION

Preserve and storage of welding consumables In general, all products that are stored in unopened original packaging can be kept with observance of the following: Electrodes, welding wires and fluxes must be protected against atmospheric influences such as rain, snow and condensation. In order to be sure that no condensation takes place in these products it is recommended to store the products in an environment which is above the dew point. This temperature is dependent on the prevailing relative humidity of air at that place.

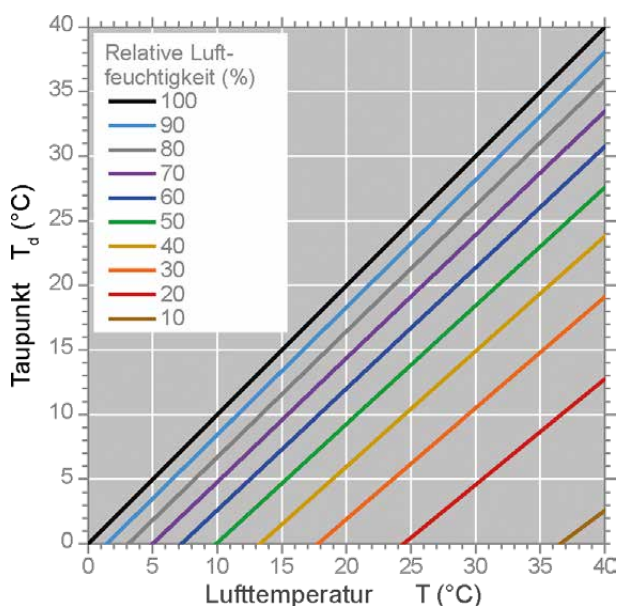

Any sudden drop in temperature should be avoided.

Prevent the formation of condensation.

Avoid falling below the dew point.

This means in the example:

Day- temperature  $30^\circ\text{C}$  to night- temperature of  $22^\circ\text{C}$  at a R. humidity of 70%

Here condensation can form on the surface of the cool wire in the morning hours.

This must be avoided.

If you have any questions, please do not hesitate to contact us.

(Source of the graphic: <https://de.wikipedia.org/wiki/Taupunkt>)

## ISO 9606:

The ISO's goal of testing welders all over the world according to the same standard has finally been realized after many years. Since October 2013, there is now the EN ISO 9606-1 standard for welder testing on steel.

EN ISO standards for the testing of welders are available for the following materials:

- EN ISO 9606-1 Steels
- EN ISO 9606-2 Aluminum/aluminum alloys
- EN ISO 9606-3 Copper/copper alloys
- EN ISO 9606-4 Nickel/nickel alloys,
- EN ISO 9606-5 Titanium/titanium alloys, zirconium/zirconium alloys

Important: This orientation contains the information most often needed to perform a welder's test, based on the experience of the standard. In no case does it replace the original text of the referenced standards. In case of doubt, the language version in which the relevant standard was prepared is used.

### Why welding tests?

The welder's examination is used for preventive quality assurance in manual welding. By passing the welder's examination, the welder qualifies to perform high-quality welding work within the scope of validity of his examinations, as well as all other joints classified as easier to weld according to this standard. Appropriate training and/or welding practice is required.

### What are the influencing variables?

The following influencing variables are defined:

- Welding process(es)
- Product form (sheet, pipe)
- Type of weld (butt or fillet weld)
- Material group of the filler metal
- Type of filler metal
- Dimensions (material, weld metal thickness and outside diameter)
- Welding positions
- Welding seam details (pool protection, root protection, seam buildup, welding direction)

The material group of the base material used, current type and polarity as well as the shielding gas must be listed informatively on the test certificate.

### Welding processes according to EN ISO 4063

- 111 Manual arc welding with stick electrode
- 114 Metal arc welding with flux-cored wire electrode without shielding gas
- 121 Submerged arc welding with solid wire electrode (partially mechanized)
- 125 Submerged arc welding with flux-cored wire electrode (partially mechanized)
- 131 Metal inert gas welding with solid wire electrode (MIG)
- 135 Metal active gas welding with solid wire electrode (MAG)
- 136 Metal active gas welding with welding powder-filled wire electrode ( rutil, basic)
- 138 Metal active gas welding with metal powder-filled wire electrode
- 141 Tungsten inert gas welding with solid wire or solid rod additive (TIG)
- 142 Tungsten inert gas welding without welding additive
- 143 Tungsten inert gas welding with flux cored wire or flux cored rod additive
- 145 Tungsten inert gas welding with solid wire or solid rod filler, inert gas with reducing gas components
- 15 Plasma welding
- 311 Gas welding with oxygen-acetylene flame

## Welding task

A distinction is made between:

plate butt weld: P BW

pipe butt weld: T BW

plate fillet weld: P FW

pipe fillet weld: T FW

**Note:** Butt welds do not qualify fillet welds or vice versa.

## Which welding consumable?

### Steel groups

Groups	Filler metal for welding	Examples of applicable standards for filler metals
FM1	Unalloyed steels and fine-grained steels	ISO 2560,[2] ISO 14341,[8] ISO 636,[1] ISO 14171,[6] ISO 17632[14]
FM2	High strength steels	ISO 18275,[21] ISO 16834,[13] ISO 26304,[25] ISO 18276[22]
FM3	High-temperature steels $Cr < 3.75$	ISO 3580,[3] ISO 21952,[23] ISO 24598,[24] ISO 17634[16]
FM4	High temperature steels $3.75\% < Cr < 12\%$	ISO 3580,[3] ISO 21952,[23] ISO 24598,[24] ISO 17634[16]
FM5	Stainless and heat resistant steels	ISO 3581,[4] ISO 14343,[9] ISO 17633[15]
FM6	Nickel and Nickel alloys	ISO 14172,[7] ISO 18274[20]

## Aluminum and aluminum alloys according to DIN EN 573

Groups	Description
21	Pure aluminum with $\leq 1\%$ impurities or alloying constituents
22	Non-age-hardenable alloys
22.1	Aluminum-manganese alloy
22.2	Aluminum-magnesium alloys with $Mg \leq 1.5\%$
22.3	Aluminum-magnesium alloys with $1.5\% < Mg \leq 3.5$
22.4	Aluminum-magnesium alloy with $Mg > 3.5\%$
23	Age-hardenable aluminum alloys
23.1	Aluminum-magnesium-silicon alloys
23.2	Aluminum-zinc-magnesium alloys
24	Aluminum-silicon alloys with $Cu \leq 1\%$
24.1	Aluminum-silicon alloys with $Cu \leq 1\%$ u. $5\% < Si \leq 15\%$
24.2	Aluminum-silicon-magnesium alloys $Cu \leq 1\%$ , $5\% < Si \leq 15\%$ and $0.1\% < Mg \leq 0.80\%$
25	Aluminum-silicon-copper alloys with $5.0\% < Si \leq 14.0\%$ ; $1.0\% < Cu \leq 5.0\%$ and $Mg \leq 0.8\%$ .
26	Aluminum-copper alloys with $2\% < Cu \leq 6\%$ .

**Groups 21 to 23 are generally plasticizing materials**

**Groups 24 to 26 are generally casting materials**

**Copper and copper alloys, groups 31, 32, 33, 34, 35, 36, 37 und 38**

Material groups	Description
31	Copper with up to 6 % Ag and 3 % Fe
32	Copper-zinc alloys
32.1	Copper-zinc alloys, two-component alloys
32.2	Copper-zinc alloys, multi-component alloys
33	Copper-tin alloys
34	Copper-nickel alloys
35	Copper-aluminum alloys
36	Copper-nickel-zinc alloys
37	Copper alloys, low-alloyed (less than 5 % other alloying elements), as far as not included in groups 31 to 36
38	Other copper alloys (5 % or more other alloying elements), as far as not included in groups 31 to 36

**Nickel and nickel alloys, groups 41, 42, 43, 44, 45, 46, 47 und 48**

Material groups	Description
41	Pure nickel
42	Nickel-copper alloys (Ni-Cu) with Ni $\geq$ 45%, Cu $\geq$ 10%.
43	Nickel-chromium alloys (Ni-Cr-Fe-Mo) with Ni $\geq$ 40 %.
44	Nickel-molybdenum alloys (Ni-Mo) with Ni $\geq$ 45 %, Mo $\leq$ 32 %.
45	Nickel-iron-chromium alloys (Ni-Fe-Cr) with Ni $\geq$ 31 %.
46	Nickel-chromium-cobalt alloys (Ni-Cr-Co) with Ni $\geq$ 45%, Co $\geq$ 10%.
47	Nickel-iron-chromium-copper alloys (Ni-Fe-Cr-Cu) with Ni $\geq$ 45 %.
48	Nickel-iron-cobalt alloys (Ni-Fe-Co-Cr-Mo-Cu) with 31 % $\leq$ Ni $\leq$ 45 % and Fe $\geq$ 20 %.

**Titanium and titanium alloys, groups 51, 52, 53 und 54**

Material groups	Description
51	Pure titanium
51.1	Titanium with O <sub>2</sub> $\leq$ 0.20 %
51.2	Titanium with 0,20 % < O <sub>2</sub> $\leq$ 0,25 %
51.3	Titanium with 0,25 % < O <sub>2</sub> $\leq$ 0,35 %
51.4	Titanium with 0,35 % < O <sub>2</sub> $\leq$ 0,40 %
52	Alpha alloys such as Ti-0.2Pd; Ti-2.5Cu; Ti-5Al-2.5Sn; Ti-8Al-1Mo-1V; Ti-6Al-2Sn-4Zr-2Mo; Ti-6Al-2Nb-1Ta-0.8Mo
53	Alpha-beta alloys such as Ti-3Al-2.5V; Ti-6Al-4V; Ti-6Al-6V-2Sn; Ti-7Al-4Mo
54	Similar to beta and beta alloys such as Ti-10V-2Fe-3Al; Ti-13V-11Cr-3Al; Ti-11.5Mo-6Zr-4.5Sn; Ti-3Al-8V-6Cr-4Zr-4Mo.

**Welding positives according to ISO 6947:**

PA, PB, PC, PD, PE, PF, PG, H-L045

Seam types are divided into:

ss	One side welding
bs	Double sided welding
nb	Welding without weld backing
mb	Welding with backing
sl	Fillet welds: Single layer
ml	Fillet welds: multi layer
lw	To the left welding process 311
rw	After right-welding process 311

**Example of a test certificate according to standard**

ISO 960-1	141	T	BW	FM	S	S3.6 D60	PH	ss nb
↓	↓	↓	↓	↓	↓	↓	↓	↓
Norm		Product form		Welding filler metal group		Dimension of the test piece		Welding seam details
	Welding process		Seam type		Welding filler metal		Welding position	

**Informatively, there are two material groups outside ISO 9606:**

#### **Zirconium and zirconium alloys, groups 61 and 62**

Groups	Description
41	Pure zirconium
42	Zirconium with 2.5% Nb

#### **Cast iron Groups 71, 72, 73, 74, 75 and 76**

Groups	Description
71	Cast iron with lamellar graphite with specified tensile strength or Brinell hardness
72	Spheroidal graphite cast iron with specified mechanical-technological parameters
72.1	Ferritic spheroidal graphite cast iron with specified tensile strength, 0.2% proof stress, elongation at fracture and specified impact energy.
72.2	Ferritic spheroidal graphite cast iron with specified tensile strength, 0.2% proof stress and elongation at fracture, or specified Brinell hardness.
72.3	Spheroidal graphite cast iron EN-GJS-500-7 and EN-GJS-450-10 (if > 20% pearlite) or specified Brinell hardness
72.4	Pearlitic spheroidal graphite cast iron with specified tensile strength, 0.2% proof stress and elongation at fracture or specified Brinell hardness
73	Malleable iron
74	Bainitic cast iron
75	Austenitic cast iron
76	Cast iron not included in groups 71 to 75

## P-number, F-number and A-number for welding (ASME Section IX)

ASME Boiler and pressure vessel code (BPVC) has assigned specific numbers to both base materials and filler metals (electrodes).

For base materials, ASME has assigned two numbering systems, these are:

- P numbers
- Group numbers

For filler metals, the numbering system is defined as follows:

- F-numbers
- A-numbers

These numbers can be found in ASME BPVC Section IX, see Table-1 for details;

	Number	Too sorted	Where to find
1	P number	Base metal	Table QW/QB-422
2	G number	Base metal	Table QW/QB-422
3	F number	Welding consumables	Table QW-432
4	A number	Welding consumables	Table QW-442

### BASE GROUPS MATERIAL:

The main purpose of assigning this numbering system is to reduce the number of procedural qualifications (PQR). Performing a procedure qualification is very time consuming and costly due to the following procedural requirements:

- Preparation of the test piece
- Welding the test coupon and
- Sending to a laboratory Preparation of the test pieces for destructive testing.



To reduce these costly and time-consuming activities, ASME has grouped base materials and assigned specific P numbers to each group of metals. This grouping of base materials was based on the following parameters:

- material composition
- Weldability
- Mechanical properties

Although not all materials with the same P number have the same properties, ASME has made this logical grouping considering the above parameters.

#### Why is this grouping necessary?

Suppose we change the base material from an existing qualified WPS and if the new base material falls into the same „P“ number, then requalification of the existing WPS is not required, i.e., no new PQR is needed.

However, this does not mean that one can simply replace the base material from an existing WPS with the same „P“ number at any time. Any time the base material from existing WPS is changed, compatibility must be considered with respect to the following factors:

- Metallurgical property
- Mechanical properties
- Design considerations
- Operating requirements
- Heat treatment

	Base metal	P Number
1	Steel and steel alloys	P-No. 1 - 15F
2	Aluminum and aluminum alloys	P-No. 21 - 26
3	Copper and copper alloys	P-No. 31 - 35
4	Nickel and nickel alloys	P-No. 41 - 49
5	Titanium and titanium alloys	P-No. 51 - 53
6	Zircon and zircon alloys	P-No. 61 - 62

#### WELDING CONSUMABLE (ELECTRODE/WELDING ROD) GROUPING:

##### Die F-Number:

F-number grouping (for filler metals) is performed to reduce the number of welding procedure specifications (WPS) and welder tests.

The basis for F-number grouping is usability properties. Usability properties essentially determine a welder's ability to produce flawless welds with a particular filler metal.

Therefore, it is assumed that a welder who can produce satisfactory welds with a particular filler metal is also capable of welding with all filler metals belonging to that particular F-number.

	Filler metal from	F Number
1	Steel and steel alloys	F No. 1 - 6
2	Aluminum and aluminum alloys	F No. 21 - 26
3	Copper and copper alloys	F No. 31 - 37
4	Nickel and nickel alloys	F No. 41 - 46
5	Titanium and titanium alloys	F No. 51 - 56
6	Zircon and zircon alloys	F No. 61
7	Electrodes for hardfacing	F No. 71 - 72

The grouping according to F-numbers does not mean that one can simply replace the filler metal (electrode/welding rod) from existing WPS with the same F-number at any time. Any time the filler metal (electrode/welding rod) from existing WPS is changed, compatibility must be considered with respect to the following factors:

- Metallurgical property
- Mechanical properties
- Design considerations
- Operating requirements
- Heat treatment

#### The A-Number:

Another type of grouping for filler metal or welding wire is the ,A' number. The ,A' number grouping was made based on the chemical composition of the fused weld metal.

### WELD METAL ANALYSIS

#### A-NUMBER

Classification of the ferrous weld metal analysis for the process qualification

A-Nr.	Type weld metal	Analysis %					
		C	Cr	Mo	Ni	Mn	Si
1	non alloyed	0,15	-	-	-	1,60	1,00
2	C-Mo	0,15	0,50	0,40-0,65	-	1,60	1,00
3	Cr (0,4-2 %)-Mo	0,15	0,40-2,00	0,40-0,65	-	1,60	1,00
4	Cr (2-6 %)-Mo	0,15	2,00-6,00	0,40-1,50	-	1,60	2,00
5	Cr (6-10,5)-Mo	0,15	6,00-10,50	0,40-1,50	-	1,20	2,00
6	Cr-Martensitic	0,15	11,00-15,00	0,70	-	2,00	1,00
7	Cr-Ferritic	0,15	11,00-30,00	1,00	-	1,00	3,00
8	Cr-Ni	0,15	14,50-30,00	4,00	7,50-15,00	2,50	1,00
9	Cr-Ni	0,30	25,00-30,00	4,00	15,00-37,00	2,50	1,00
10	Ni- 4%	0,15	-	0,55	0,80-4,00	1,70	1,00
11	Mn-Mo	0,17	-	0,25-0,75	0,85	1,25-2,25	1,00
12	Ni-Cr-Mo	0,15	1,5	0,25-0,80	1,25-2,80	0,75-2,25	1,00

**ELECTRODE GROUPS****F-NUMBER**

Grouping of electrodes and welding wires for qualification

F-Nr.	AWS Specification	AWS Classification
<b>Steel and steel alloys</b>		
1	A5.1	EXX20, EXX22, EXX24, EXX27, EXX28
1	A5.4	EXXX(X)-25, EXXX(X)-26
1	A5.5	EXX20-XX, EXX27-XX
2	A5.1	EXX12, EXX13, EXX14, EXX19
2	A5.5	E(X)XX13-XX
3	A5.1	EXX10, EXX11
3	A5.5	E(X)XX10-XX, E(X)XX11-XX
4	A5.1	EXX15, EXX16, EXX18, EXX18M, EXX48
4	A5.4 Other than austenite and duplex	EXXX(X)-15, EXXX(X)-16, EXXX(X)-17
4	A5.5	E(X)XX15-XX, E(X)XX16-XX, E(X)XX18-XX, E(X)XX18M, E(X)XX18M1
5	A5.4 austenite and duplex	EXXX(X)-15, EXXX(X)-16, EXXX(X)-17
6	A5.2	RX
6	A5.9	ERXXX(XXX), ECXXX(XXX), EQXXX(XXX)
6	A5.17	FXXX-EXX, FXXX-ECX
6	A5.18	ERXXS-X, EXXC-X, EXXC-XX
6	A5.20	EXXT-X, EXXT-XM
6	A5.22	EXXTX-X, RXXXT1-5
6	A5.23	FXXX-EXXX-X, FXXX-ECXXX-X
6	A5.23	FXXX-EXXX-XN, FXXX-ECXXX-XN
6	A5.25	FESXX-EXXX, FESXX-EWXX
6	A5.26	EGXXS-X, EGXXT-X
6	A5.28	ERXXS-XXX, EXXC-XXX
6	A5.29	EXXTX-X
6	A5.30	INXXX
<b>Aluminum and aluminum alloys</b>		
21	A5.3	E1100, E3003
21	A5.10	ER1100, R1100, ER1188, R1188
22	A5.10	ER5183, R5183, ER5356, R5356, ER5554, R5554, ER5556, R5556, ER5654, R5654
23	A5.3	E4043
23	A5.10	ER4009, R4009, ER4010, R4011, R4010, ER4043, R4043, ER4047, R4047, ER4145, R4145, ER4643, R4643
24	A5.10	R206.0, R-C355.0, R-A356.0, R357.0, R-A357.0
25	A5.10	ER2319, R2319

## ELECTRODE GROUPS F-NUMBER

Grouping of electrodes and welding wires for qualification

F-Nr.	AWS Specification	AWS Classification
<b>Copper and copper alloys</b>		
31	A5.6 and A5.7	RCu, ECu
32	A5.6	ECuSi and ERCuSi-A
33	A5.6 and A5.7	ECuSn-A, ECuSn-C, ERCuSn-A
34	A5.6, A5.7 and A5.30	ECuNi, ERCuNi, IN67
35	A5.8	RBCuZn-A, RBCuZn-B, RCuZn-C, RBCuZn-D
36	A5.6 and A5.7	ERCuAl-A1, ERCuAl-A2, ERCuAl-A3, ECuAl-A2, ECuAl-B
37	A5.6 and A5.7	RCuNiAl, ECuMnNiAl, ERCuNiAl, ERCuMnNiAl
<b>Nickel and Nickel alloys</b>		
41	A5.11, A5.14, and A5.30	ENi-1, ERNi-1, IN61
42	A5.11, A5.14, and A5.30	ENiCu-7, ERNiCu-7, ERNiCu-8, IN60
43	A5.11	ENiCrFe-1, 2, 3, 4, 7, 9, and 10; ENiCrMo-2, 3, 6, and 12; ENiCrCoMo-1
43	A5.14	ERNiCr-3, 4, and 6; ERNiCrFe-5, 6, 7, 8, and 11; ERNiCrCoMo-1; ERNiCrMo-2 and 3
43	A5.30	IN6A, IN62, IN82
44	A5.11	ENiMo-1, 3, 7, 8, 9, and 10; ENiCrMo-4, 5, 7, 10, 13, and 14
44	A5.14	ERNiMo-1, 2, 3, 7 (B2), 8, 9, and 10; ERNiCrMo-4, 7 (alloy C4), 10, 13, 14; ERNiCrWMo-1
45	A5.11	ENiCrMo-1, 9, and 11
45	A5.14	ERNiCrMo-1, 8, 9, and 11; ERNiFeCr-1
<b>Titanium and titanium alloys</b>		
51	A5.16	ERTi-1, ERTi-2, ERTi-3, ERTi-4
52	A5.16	ERTi-7
53	A5.16	ERTi-9, ERTi-9ELI
54	A5.16	ERTi-12
55	A5.16	ERTi-5, ERTi-5ELI, ERTi-6, ERTi-6ELI, ERTi-15
<b>Zircon and zircon alloys</b>		
61	A.5.24	ERZr2, ERZr3, ERZr4
<b>Hardfacing electrodes</b>		
71	A5.13 and A5.21	RXXX-X, EXXX-X
<b>Magnesium alloys</b>		
91	A.519	ERAZ61A, ERAZ92A, ER EZ33A, ERAZ101A, RAZ61A, RAZ92A, RAZ101A, R EZ33A

**Designation of steels:**

The designation of steels is carried out according to

- DIN EN 10027-1:2017-01, Designation systems for steels - Part 1: Short names
- DIN EN 10027-2:2015-07, Designation systems for steels - Part 2: Numbering system

Here a distinction is made between designation by the following designation system

- Steel standardization by short names
- designation of steels according to their use or mechanical or physical properties
- Identification of steels according to chemical composition
- Steel standardization by material numbers
- Standardization of cast iron materials

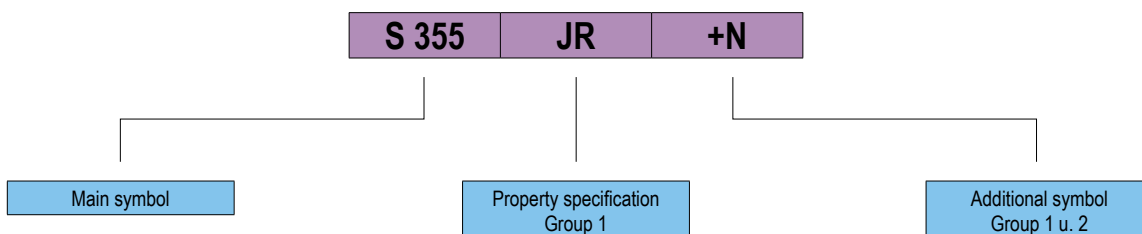

Main symbol		Additional symbol (selection)		
Code letter and scope of application	Yield Strength Re	Group 1		Group 2
S = Steels for general steel construction	Number of minimum yield strength in MPa. 355 MPa	Notched bar impact energy Test temp. °C see following table 27J bei 20°C Test temp.	N = Normalized annealed or normalizing annealed	Special properties Example: E = for enameling see following table

Main symbol	Steel type (use)	Features
B	Concrete steels	Characteristic yield strength
D	Flat products for cold forming	
DC	Cold rolled flat products	Code number 2-digit
DD	Hot rolled flat products for direct cold forming	Code number 2-digit
DX	Type of rolling (cold or hot) not specified	Code number 2-digit
E	Engineering steels	Minimum yield strength for the smallest product thickness
G	Cast steel (if required)	Minimum yield strength
H	Cold-rolled flat products made of high-strength steels for cold forming	Minimum yield strength
HT	Same like H	Minimum yield strength
L	Steels for line pipe	Minimum yield strength for the smallest product thickness
M	Electrical sheet and strip	Maximum permissible core losses
P	Steels for the pressure vessel	Minimum yield strength for the smallest product thickness
R	Rail steels	Minimum tensile strength
S	Steels for general steel construction	Minimum yield strength for the smallest product thickness
T	Ultrafine and tinplate and strip	
Y	Prestressing steels	

The property data for the respective steel are appended directly to the main symbol without spaces (group 1).

For engineering steels and steels for structural steelwork, the property data are divided into two groups.

Group 1 contains information on properties relating to impact energy and heat treatment, as well as the possibility of specifying special characteristics.

Charpy V			Test temp.
27J	40J	60J	°C
JR	KR	LR	20
J0	K0	L0	0
J2	K2	L2	-20
J4	K4	L4	-40

The Group 1 additional symbol contains information on properties of a particular type or suitability depending on the respective steel group or product group.

Group 1	Steel type (use)	Main symbol
M	Thermomechanical rolled	S, P, L, H
N	Normalized annealed or normalizing annealed	S, P, L
Q	Quenched	S, P, L, Y
B	Gas cylinders	P
S	Simple pressure vessel	P
T	For Tube	P;D
C	cold drawn wire	Y
H	Hot drawn or prestressed bars	Y
S	Litze	Y
Mn	High manganese	R
Cr	Chrom alloyed	R
B	Bake hardening	H
P	Phosphorus alloyed	H
X	Dualphase	H
Y	Interstitial free steel (IF-Stahl)	H
D	Hot dip coating	D
EK	for functional enameling	D
ED	for direct enamel	D
H	for hollow sections	D
G	for other characteristics with 1 or 2 digits if necessary	S, P, L, E, Y, R, H, D

Depending on the main group, the main Symbols can be extended by the following group 2 Symbols:

Group 2	Steel type (use)	Main Symbol Group
C	with special cold formability	S, E
D	for enamel coatings	S, H
E	for enameling	S
F	Forging	S
H	Hollow profiles	S, D
H	High temperature	P
L	for low temperatures	P, S
M	Thermomechanically rolled	S
N	Normalized or normalizing rolled	S
O	for Offshore	S
P	Sheet piling steel	S
Q	Quenched	S, R
R	Roomtemp.	P
S	for shipbuilding	S
T	For tubes	S
W	Weatherresistant	S
X	High and low temperature	P

**Designation of steels according to chemical composition**

<b>C</b>	<b>45</b>	<b>U</b>
----------	-----------	----------

Steels that are not classified according to their use can be differentiated according to their chemical composition. Four subgroups can be differentiated here.

- Unalloyed steels, content of manganese less than 1%.
- Alloyed steels, content of each alloying element below 5 %/unalloyed steels with manganese content above 1 %/unalloyed free-cutting steels
- Alloyed steels, content of any alloying element above 5 %.
- High speed steels

**Unalloyed steels with a manganese content of less than 1%.**

The symbolism listed in the following table applies to unalloyed steels with a manganese content < 1%, except for free-cutting steels

Main symbol	Additional symbol
C and key figure for carbon content (key figure = carbon content in % * 100)	E maximum sulfur content
	R Sulfur content range
	C special suitability for cold forming
	G Other features
	S For springs
	U For tools
	W for welding rod and wire
	D for wire drawing

**Alloyed steels, content of each alloying element below 5 % /unalloyed steels with manganese content above 1 % /unalloyed free-cutting steels**

<b>16</b>	<b>MnCr</b>	<b>5</b>
-----------	-------------	----------

The designation is composed of:

- Carbon content index (index = carbon content \* 100).
- Chemical symbols of alloying elements
- Content of alloying elements multiplied by factors (see table).

Alloying elements	Faktor
Cr, Co, Mn, Ni, Si, W	4
Al, Cu, Mo, Pb, Ta, Ti, V	10
C, N, P, S	100
B	1000



**Alloyed steels, content of an alloying element above 5%.**

X	10	CrNi	18-8
---	----	------	------

The designation is composed of:

- Designation X for high-alloy steels
- Code for carbon content (code = carbon content /100)
- Chemical symbols of the various alloying elements
- Direct percentage of the alloying elements used

**High-speed steels**

HS	6	-5	-2	-5
----	---	----	----	----

The designation consists of:

- HS marking for high-speed steel
- the contents of the alloying elements directly in percent (**order: tungsten, molybdenum, vanadium, cobalt**).

## Numbering system for materials - main groups

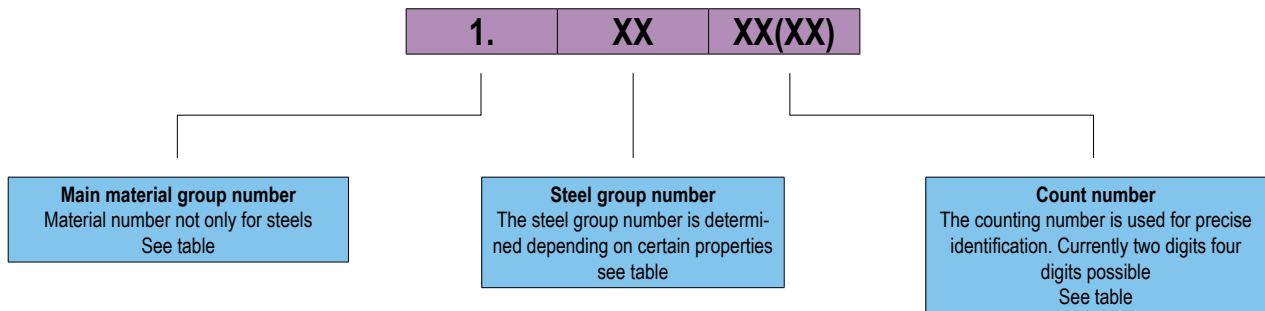

Grade number. Steel group number Count number	Group
<b>Raw and cast iron</b>	
0.0000-0.2999	Raw and cast iron
0.3000-0.4999	Master alloys
0.5000-0.5999	Reserve
0.6000-0.6999	GJL - cast iron, lamellar graphite
0.7000-0.7999	GJS - cast iron, nodular graphite
0.8000-0.8999	GJMB- Malleable iron Black GJMW - Malleable Iron White
0.9000-0.9999	Special casting
<b>Basic steel</b>	
1.0000-1.0099	Basic steel
<b>Mass steels / unalloyed quality steels</b>	
1.0100-1.0799	1.0100 - 1.0199 Quality steel (General structural steels with Rm < 500 MPa ) 1.0200 - 1.0299 Other structural steels (Not intended for heat treatment with Rm < 500 MPa ) 1.0300 - 1.0399 Steels with average C < 0,12% or Rm < 400 MPa 1.0400 - 1.0499 Steels with C = 0,12...0,25 % or Rm 400...500 MPa 1.0500 - 1.0599 Steels with C = 0,25...0,55 % or Rm 500...700 MPa 1.0600 - 1.0699 Steels with C ≥ 0,55 % or Rm ≥ 700 MPa 1.0700 - 1.0799 Steels with higher P or S content
<b>Alloy Steels</b>	
1.0800-1.0999	1.08XX Steels with special physical properties 1.09XX Steels for other applications

Grade number. Steel group number Count number	Group
<b>Non-alloy special steels</b>	
1.1000-1.1899	1.1000 - 1.1099 Steels with special physical properties 1.1100 - 1.1199 Structural pressure vessel and engineering steels with C < 0,5% 1.1200 - 1.1299 Structural pressure vessel and engineering steels with C > = 0,5% 1.1300 - 1.1399 Structural pressure vessel and engineering steels with special requirements 1.1500 - 1.1899 Structural pressure vessel
<b>Alloy Tool Steels</b>	
1.2000-1.2999	Alloy Tool Steels
1.3000-1.3999	Alloy Miscellaneous Steels 1.3200 - 1.3399 High speed steel with Co 1.3500 - 1.3599 Bearing steels 1.3600 - 1.3799 Materials with special magnetic properties without Co 1.3800 - 1.3999 Materials with special physical properties without Ni
1.4000-1.4999	Stainless and Heat Resisting steels 1.4000 - 1.4599 Stainless steel 1.4600 - 1.4699 Chemically resistant and high temperature Ni alloy 1.4700 - 1.4899 Heat resistant steel 1.4900 - 1.4999 High temperature resistant material
1.5000-1.5999	Structural, pressure vessel and engineering steels
1.6000-1.7999	Structural, pressure vessel and engineering steels
1.8000-1.8999	1.8400 - 1.8499 Construction, engineering, container steel sorted by alloying elements 1.8500 - 1.8599 Nitriding steels 1.8600 - 1.8699 Construction, engineering, container steel sorted by alloying elements 1.8700 - 1.8799 Steels not for heat treatment by user 1.8900 - 1.8999 High strength weldable steels not intended for heat treatment by user
1.9000-1.9999	Non-alloy Quality steels
<b>Nonferrous metals</b>	
2.0000-2.1799	Copper and copper alloys
2.2000-2.2499	Zinc/zinc alloys and cadmium/cadmium alloys
2.3000-2.3499	Lead and lead alloys
2.3500-2.3999	Tin and tin alloys
2.4000-2.4999	Nickel / nickel alloys and cobalt/cobalt alloys
3.0000-3.4999	Aluminum and aluminum alloys
3.5000-3.5999	Magnesium and magnesium alloys

**Hydrogen embrittlement refers to:**

The change in brittleness caused by the penetration and incorporation of hydrogen into a metal structure. This consequence of corrosion is similar to material fatigue as a result, hydrogen induced cracking occurs, limiting in particular the use of susceptible materials for hydrogen storage. The so called cold cracks, which occur after welding of High strength fine-grained structural steels, mainly in the sub-seam area, more rarely next to and in the seam, have their causes in the hydrogen introduced via the melt. This diffuses atomically and accumulates molecularly in cavities (at inclusions) until cracking occurs via the „fish-eye effect“.

In order for components to release the hydrogen again, a heat treatment of several hours at approx. 200-300 °C (low hydrogen annealing, also known as tempering) must be carried out immediately after exposure to hydrogen. Since hydrogen has a high diffusion rate even at low temperatures, it is possible to drive the hydrogen out of the steel at temperatures of up to 200 °C without metallurgical changes.

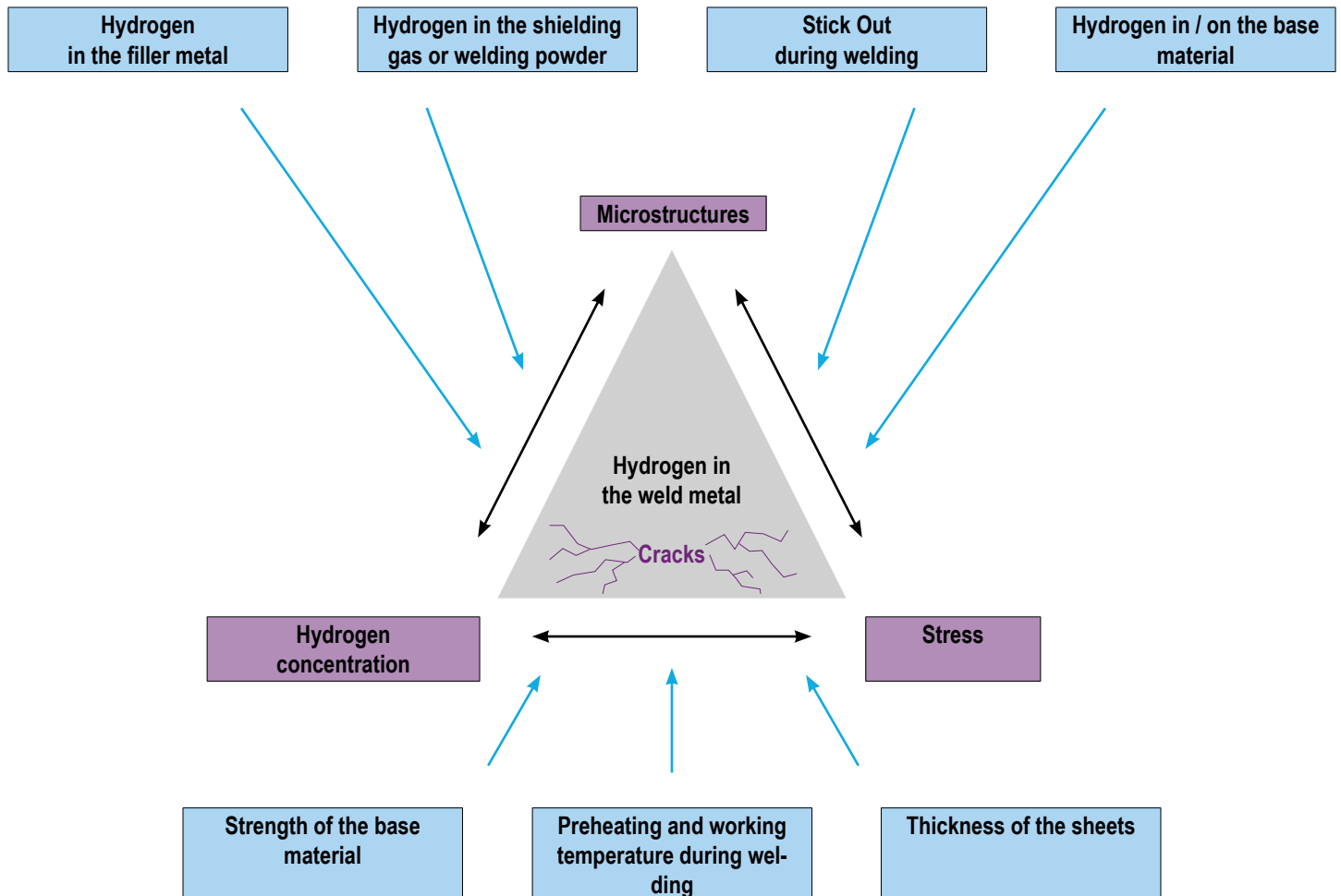
**Sources of hydrogen and interactions:**

## How to measure hydrogen in the weld metal?

### Prinzip ISO 3690 und AWS 4.3:

Mercury displacement (Complicated handling of mercury )

Carrier gas method

Carrier gas heat extraction is based on the thermal activation of interstitially dissolved hydrogen or hydrogen trapped in defects such as pores and blowholes at temperatures between 300 °C and 3000 °C. The sample chamber is continuously flowed through by a hydrogen-free gas, which is fed to the analysis together with the hydrogen outgassing from the sample. A prerequisite for the complete detection of the hydrogen is its residual recombination into hydrogen molecules. This requires the use of inert gases such as argon or nitrogen as carrier gas. The analysis of the sample gas is mainly carried out with the aid of sensors operating on a chemical or physical basis, whose output signal is proportional to the gas quantity. In the method the sample gas is analyzed by means of a thermal conductivity detector (WLD). The best results are obtained when the difference in thermal conductivity between the carrier gas and the gas to be detected is as large as possible. The maximum temperature for determining the diffusible hydrogen in the ferritic weld metal is 400 °C, since higher temperatures lead to the release of trapped hydrogen components.

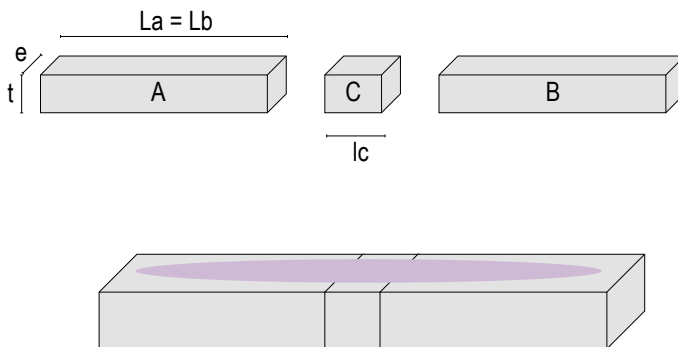

Which type of test piece depends on the welding process to be tested

Type	La=Lb (mm)	Lc (mm)	e (mm)	t (mm)
1	45	30	15	10
2	135	15	30	10
3	85	15	30	10

### Measures for hydrogen reduction in welds:

To minimize the risk of hydrogen assisted cold cracking, the hydrogen concentration in the weld must be reduced to subcritical values. This is usually done by means of elevated temperatures and is recommended by adequate heat control before, during and after welding in the applicable codes.

The use of hydrogen-controlled welding consumables is important.

Very important is also the influence of stick out. Further information on this subject can be found on the following page

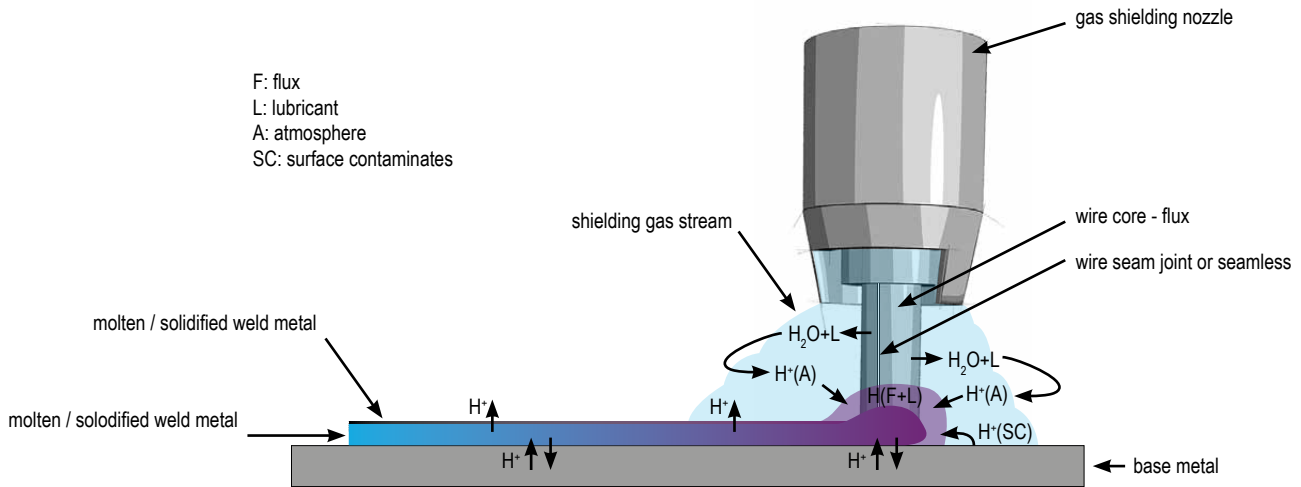

**Influence of stickout on H<sub>2</sub> and N<sub>2</sub> / O<sub>2</sub> absorption into weld metal**  
Here is an example of a test series that illustrates this

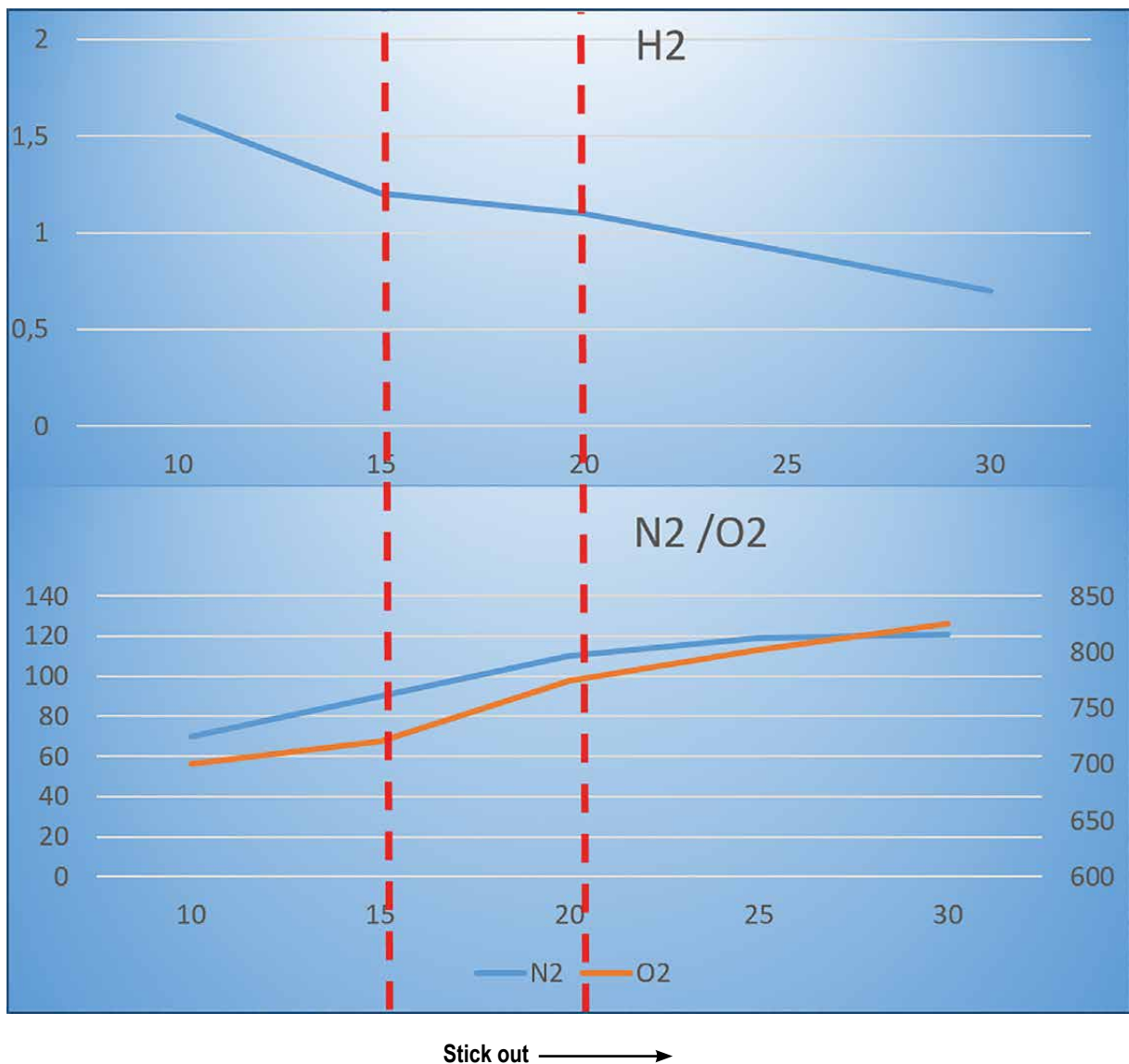

## Explanation of some terms on the MIG / MAG welding torch

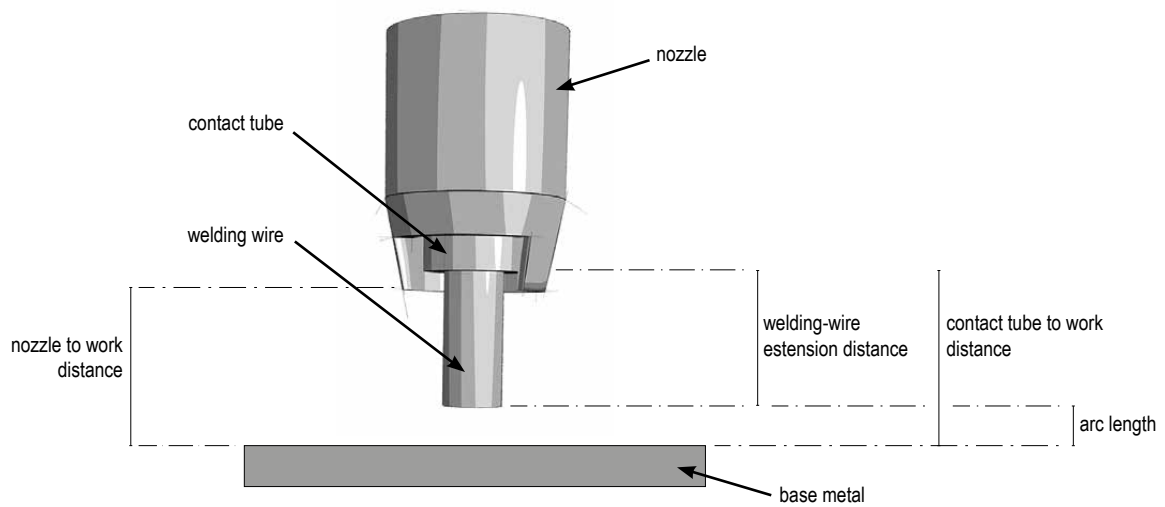

The recommendation 15 - 20 mm comes from the results of the measurements of the previous diagrams:

### Long Stick out:

- Negative impact on N<sub>2</sub> / O<sub>2</sub>
- Positive impact on H<sub>2</sub>

### Short Stick out:

- Negative impact on H<sub>2</sub>
- Positive impact on N<sub>2</sub> / O<sub>2</sub>

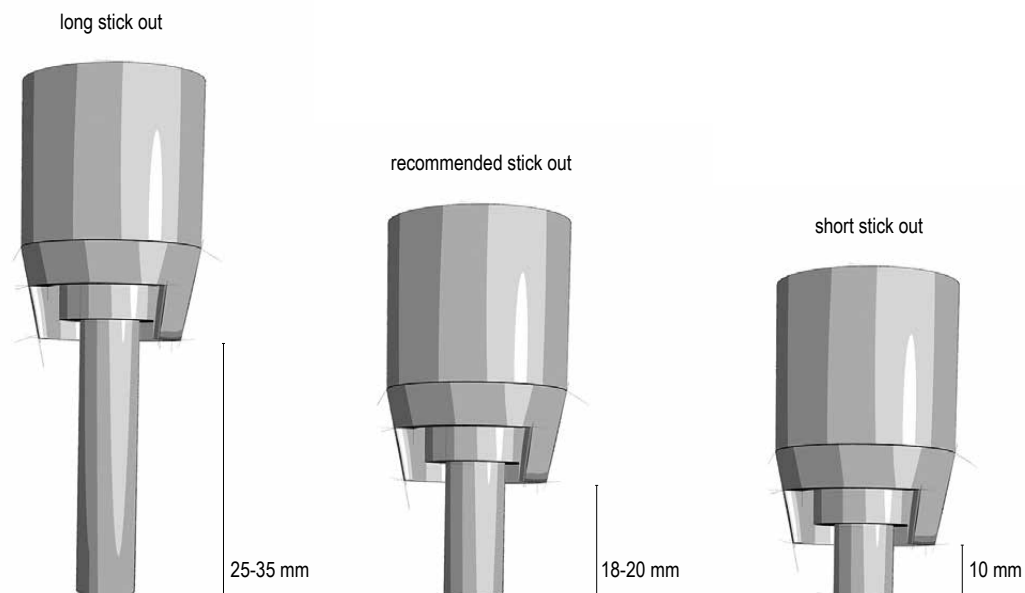





### The most beautiful packing for welding electrodes

Hydrogen disasters at high tensile strength steels was the main driver behind the development of our new re-closable thin packing for welding electrodes. Environment and other motivations were taken in consideration and end 2011 we launched the first hermetically sealable metal can on the market for welding electrodes. Thin packing seemed the best choice, 100% recyclable and now you can throw away your empty packing together with the metal scrap. Compare to the usual carton packing on the market it offers also the advantage that metal can not catch flame which is a huge step forward in fire prevention.

### The best vacuum packing for welding electrodes

In practice vacuum packed electrodes end up leaking within a certain time, upto 40% losses are faced within one year after purchasing and are oft noticed too late. The dominating „Ready and VacPack“ packing on the market finally seems to sensitive for transport and storage shifting during the years and end up leaking. With our new developed multilayer Nylon strengthened foil and a unique slide box this new Ultra Dry III packing survives extreme long storage and even rough handling during use and storage handling.

Ultra dry III vacuum packs contains only 0,7 and or 0,8 kg dry electrodes to avoid redrying in the field when electrodes are exposed for too long to humid air.

### TIG ELECTRODES

All TIG products are 1000mm long, and are delivered in card board boxes. Delivery sizes for stainless, un-, and low-alloyed are 5kg. Aluminum are delivered in 2,5kg boxes.

## A SELECTION OF AVAILABLE SPOOL TYPES OTHER TYPES UPON REQUEST

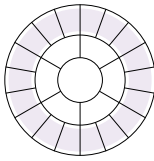
**Plastic spool („D 200“)**

Diameter: 200 mm

Width: 55 mm

Suitable for a 50 mm hub

Standard weight depending on the wire 5 kg

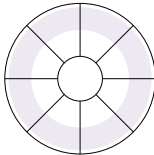
**Basket spool BS 200**

Diameter: 200 mm

Width: 55 mm

Suitable for a 50 mm hub

Standard weight depending on the wire 5 kg

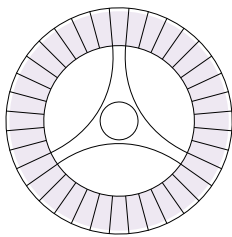
**Basket spool D 300**

Diameter: 300 mm

Width: 103 mm

Suitable for a 50 mm hub

Standard weight depending on the wire 10-18 kg

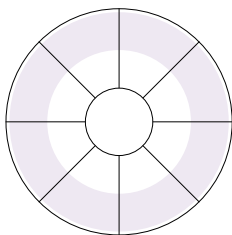
**Basket spool S 300 & BS 300**

Diameter: 300 mm

Width: 108 mm

Suitable for a 50 mm hub

Standard weight depending on the wire 10-18 kg

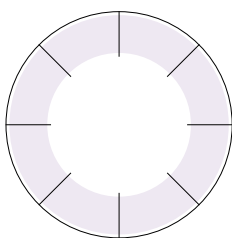
**Basket spool B 300**

Diameter: 300 mm

Width: 100 mm

Suitable for a 50 mm hub, but an adaptor needed

Standard weight depending on the wire 10-18 kg

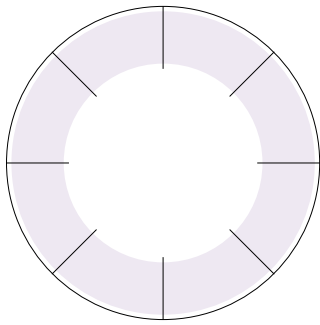

**Basket spool B 415**

Diameter: 415 mm

Width: 100 mm

Suitable for a 50 mm hub

Standard weight depending on the wire 20-30 kg

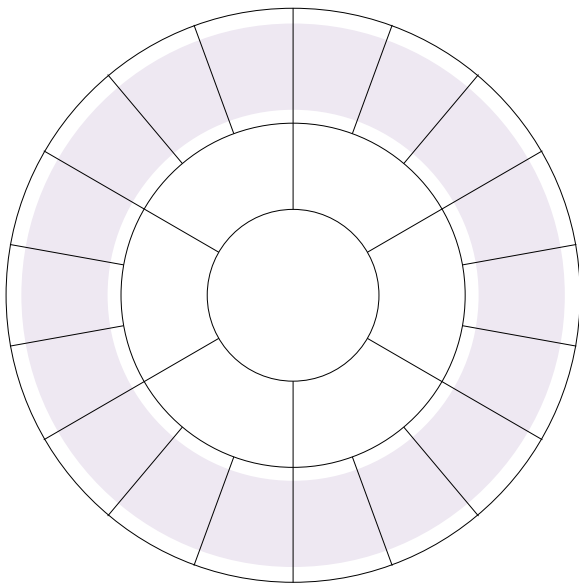

**Reel S 760**

Diameter: 7600 mm (500 mm also possible)

Width: 290 mm

Suitable for a 50 mm hub

Standard weight depending on the wire 150-300 kg

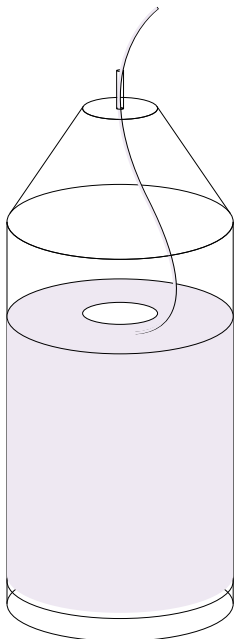

**Available barrels**

Diameter: 510-580 mm

**Accessories**

Certilas bulk pack options can be supplied with a complete set of wire dispensing equipment, from the drum dolly, wire conduit, quick connectors to drum cones. Please contact us for more information.

**Euro- Pallet**

2 per Pallet 400-700 kg

**Special Pallet (1150 x 1150 mm)**

4 per Pallet 800-1400kg

## A SELECTION OF POSSIBLE PACKING SCHEMES ON PALLETS

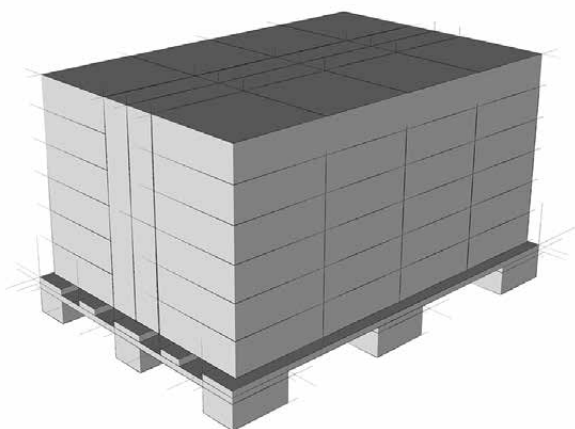
**FOR SPOOL TYPE B 300 / BS 300 / S300 / D 300**

64 Spools per Euro-Pallet (15-20 kg each spool)

Net-weight: 960 - 1152 kg

Hight incl. Pallet: ~780 mm  
 Width: ~820 mm  
 Length: ~1220 mm

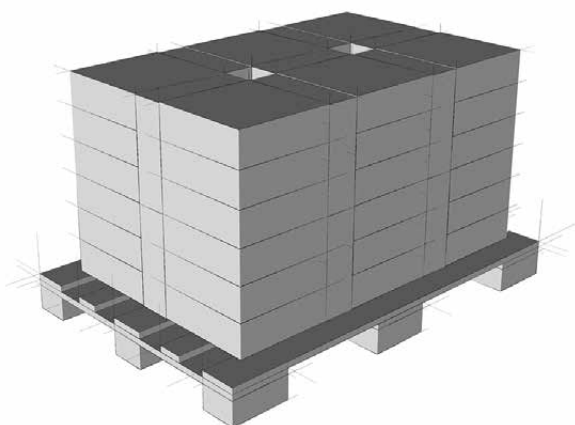
**FOR SPOOL TYPE B 300 / BS 300 / S300 / D 300**

48 Spools per Euro-Pallet (15-20 kg each spool)

Net-weight: 750 - 900 kg

Hight incl. Pallet: 780 mm  
 Width: 820 mm  
 Length: 1200 mm

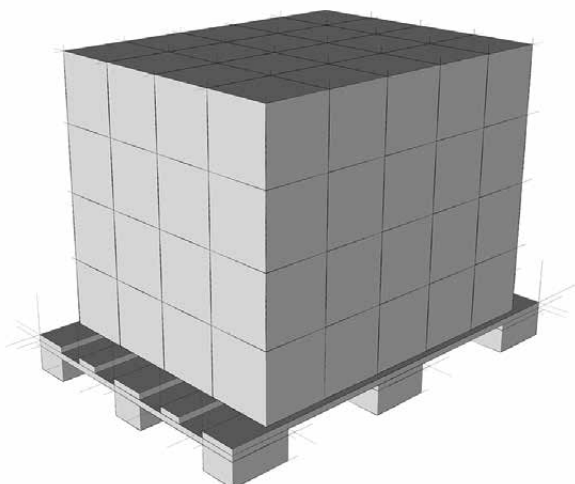
**FOR SPOOL TYPE BS 200 / D 200 Hier für Fülldraht  
Andere Varianten Verfügbar**

160 - 240 Spools per Euro-Pallet (5 kg each spool)

Net-weight: 800 -1200 kg

Hight incl. Pallet: 850 mm  
 Width: 850 mm  
 Length: 1200 mm

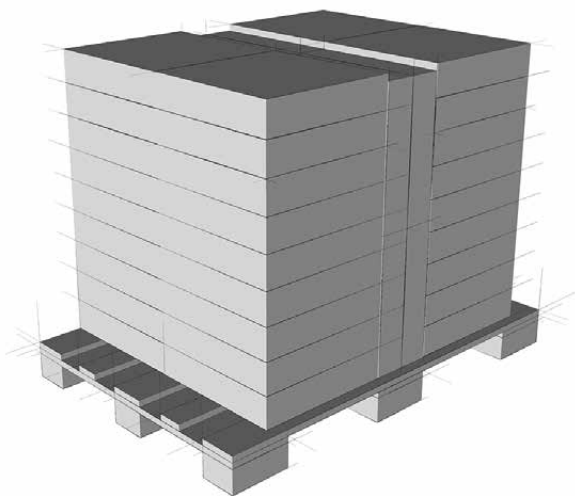

**FOR SPOOL TYPE BS 415**

**40 Spools per Euro-Pallet (20-30 kg each spool)**

Net-weight: 800 -1200 kg

Hight incl. Pallet: 850 mm  
Width: 850 mm  
Length: 1200 mm

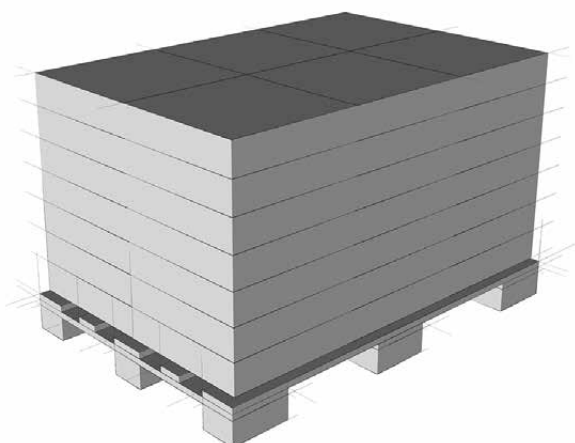

**FOR SPOOL TYPE BS 415**

**42 Spools per Euro-Pallet (20-30 kg each spool)**

Net-weight: 840 -1260 kg

Hight incl. Pallet: 850 mm  
Width: 850 mm  
Length: 1260 mm

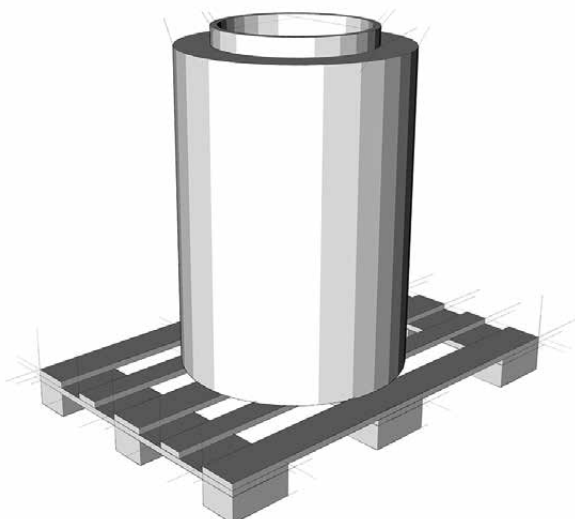

**Cardboard tube**

1 tube per Euro-Pallet

Net-weight: 850 -1000 kg

Hight incl. Pallet: 900 - 1350 mm  
Width: 800 mm  
Length: 1200 mm

**AL BAG FOR WELDING FLUX**

B 370 mm, H 620 mm, T100

Net-weight: per pack 25 kg

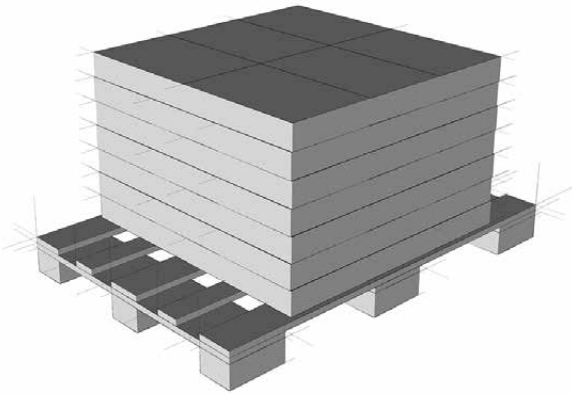
**AL Bag on Pallet**

42 per Euro-Pallet

Net-weight: 1050 kg

Hight incl. Pallet: 1000 mm

Width: 1150 mm

Length: 1150 mm

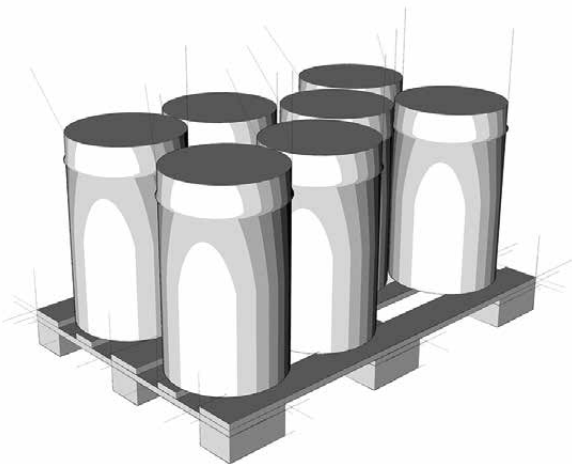
**PE and AL Bag on Pallet**

H 445 mm, d 300

Net-weight: 25 kg 18 per Euro-Pallet : ~ 450 kg

**Euro-Palett:**

Width: 820 mm

Length: 1260 mm

**also other paletts possible:**

Width: 1150 mm

Length: 1150mm

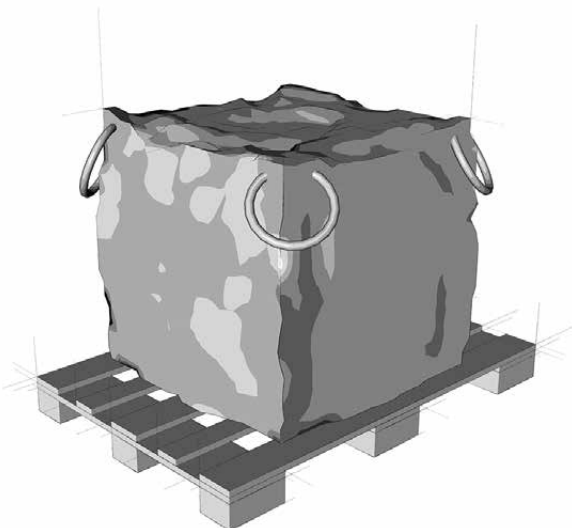
**BIG BAG****HxBxT** 1150 mm x 1150 mm x 1120 mm

Net-weight: 960 kg 1 per Palett

Hight incl. Pallet: 1120 mm

Width: 1150 mm

Length: 1150 mm

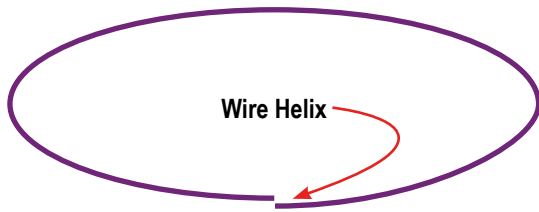

**Helix** - The helix of welding wire is the distance the unspooled wire rises from the floor. The average wire might have a helix of **25 mm** from Spools like S 200 mm over this like B 300 it can 50 mm which is acceptable for AWS and ISO but contributes to over-welding, more labor and more filler metal. The helix contributes to an oscillation of wire and therefore, makes the weld bead wider. This increases heat, distortion, time and weld cracking. Have you measured the helix of your welding wire lately?

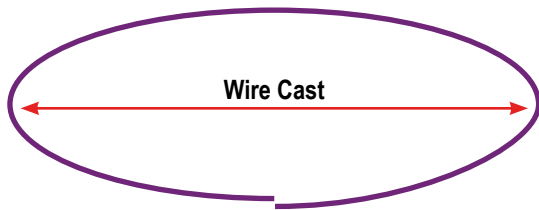

**Cast** - The cast of welding wire is essentially the diameter of the wire when you take it off of the spool. Average weld wire packaged on a spool has a cast of **660 mm** whereas a true robotic weld wire does not have cast, but instead forms a sine-wave when laid on the floor. This permits a faster welding speed and less spatter because the weld wire is precisely melted into the joint.

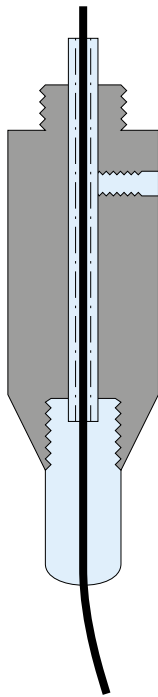

**Cast forces wire to make better electrical contact with the tip**

**Twist** - Twist is more difficult to test than the helix and the cast, but it can be done in the field. To do so, pull 4 inches of wire out of the drum or from the spool. Bend the wire 90 degrees and hold the bent portion at the 12 o'clock position. Then, pull it out 30 feet and slowly release the wire so it can rotate. One rotation in 30 feet is too much and implies issues with wire binding in the torch and may lead to knots in the drum. Spooled wire generally has the biggest issue with cast and helix while twist is less common.

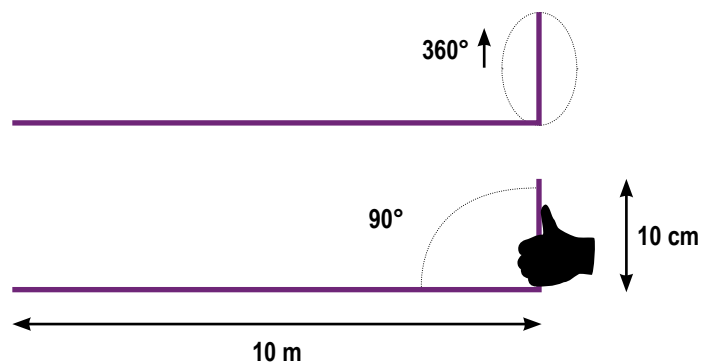



**FILLET WELDS**

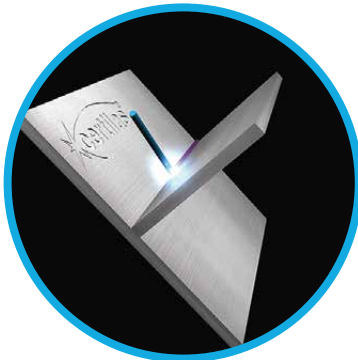

Axis of Weld Horizontal  
**Flat Position**  
ASME : 1F  
ISO: PA

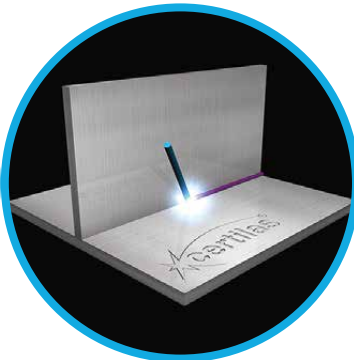

Axis of Weld Horizontal  
Horizontal Position  
ASME : 2F  
ISO: PB

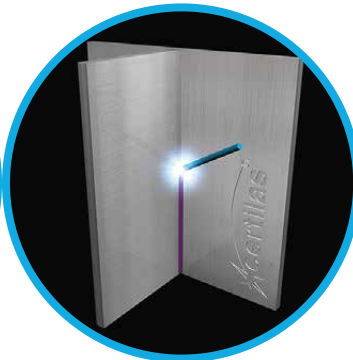

Axis of Weld Vertical  
**Vertical Position**  
ASME : 3Fu  
ISO: PF (up)



Axis of Weld Horizontal  
**Overhead Position**  
ASME : 4F  
ISO: PD

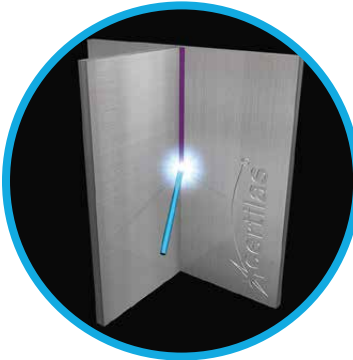

ASME : 3Fd  
ISO: PG (down)

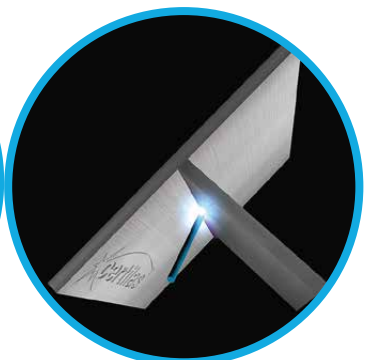

ASME : 4F  
ISO: PE

**GROOVE WELDS**

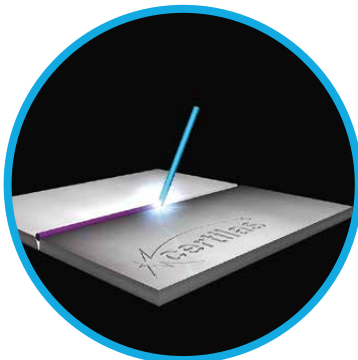

Axis of Weld Horizontal  
**Flat Position**  
ASME : 1G  
ISO: PA

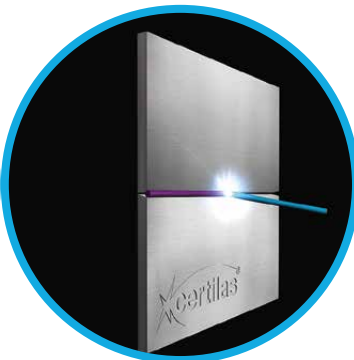

Axis of Weld Horizontal  
Horizontal Position  
ASME : 2G  
ISO: PC

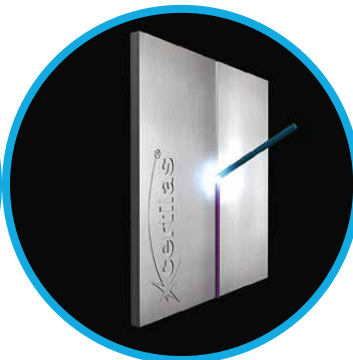

Axis of Weld Vertical  
**Vertical Position**  
ASME : 3Gu  
ISO: PF (up)

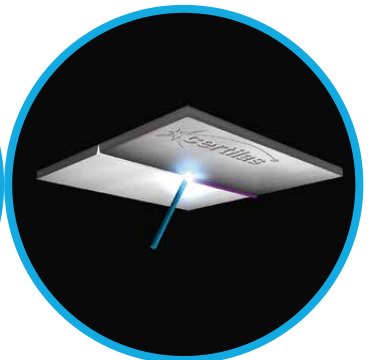

Axis of Weld Horizontal  
**Overhead Position**  
ASME : 4G  
ISO: PE

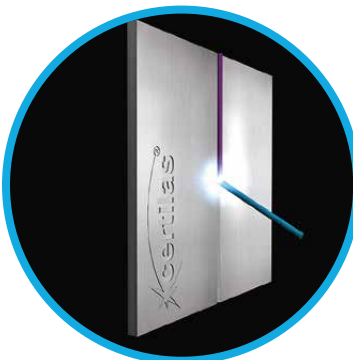

ASME : 3 Gd  
ISO: PG (down)

## GROOVE WELDS

**Flat Position**  
ASME : 1G  
ISO: PA

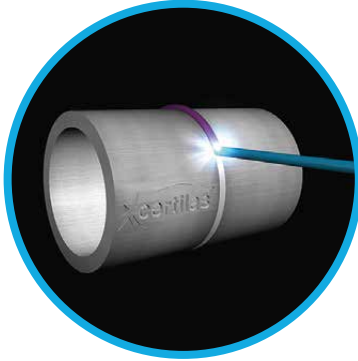

Pipe shall be turned or rolled while welding axis of pipe horizontal

**Horizontal Position**  
ASME : 2G  
ISO: PC

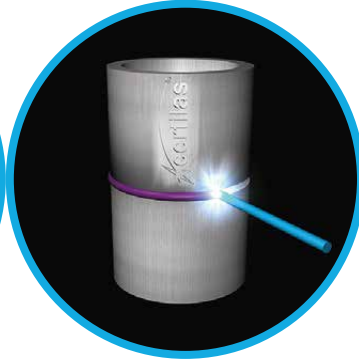

Axis of Weld vertical

**Horizontal 5G**  
ASME : 5G  
ISO: PJ (down) PH (up)

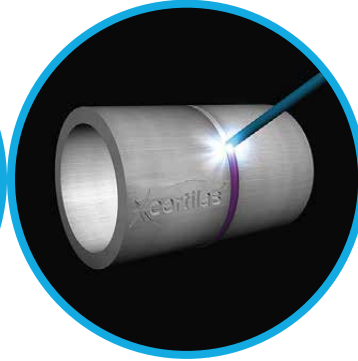

Pipe is not be turned or rolled while welding axis of pipe horizontal

**45° Fixed**  
ASME : 6G  
ISO: J-L045 (down)  
H-L45 (up)



Pipe stationary with axis approximately 45°

## Welding gun angles

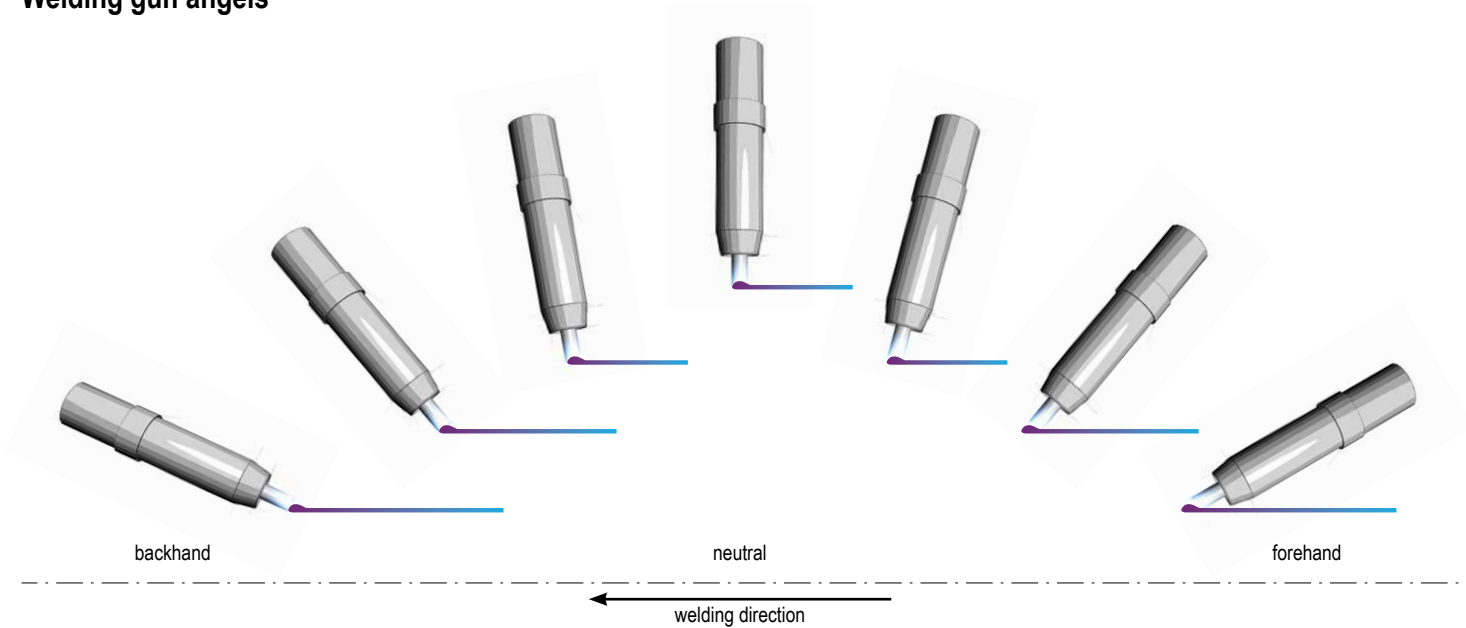

Changes in this angle affect the weld bead shape and penetration.

## Forehand / Perpendicular / Backhand Techniques

Forehand, perpendicular, and backhand are the terms most often used to describe the gun angle as it relates to the work and the direction of travel. The forehand technique is sometimes referred to as pushing the weld bead, and backhand may be referred to as pulling or dragging the weld bead. The term perpendicular is used when the gun angle is at approximately  $90^\circ$  to the work surface.

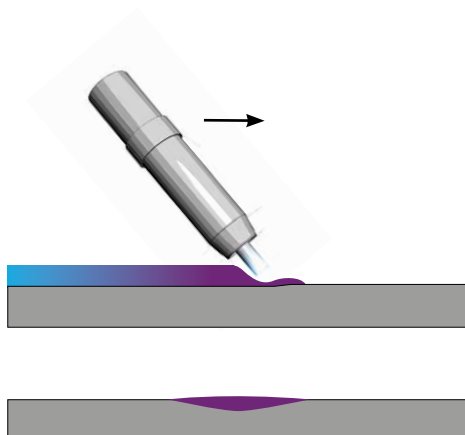
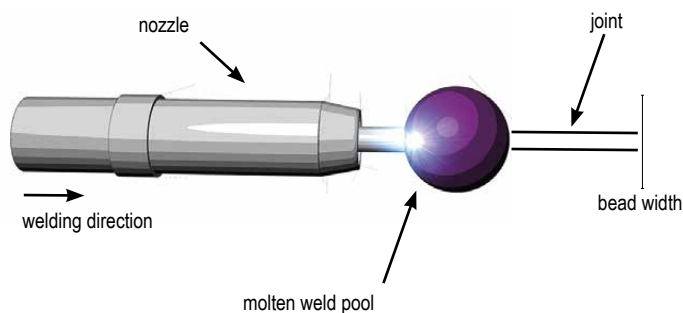

**Advantages of the Forehand Technique** The forehand welding technique has several advantages:

**Joint visibility** - You can easily see the joint where the bead will be deposited,

**Electrode extension** - The contact tube tip is easier to see, making it easier to maintain a constant extension length.

**Less weld penetration** - It is easier to weld on thin sheet metal without melting through.

**Out-of-position welds** - This technique works well on vertical up and overhead joints for better control of the weld pool.

**Disadvantages of the Forehand Technique** The disadvantages of using the forehand welding technique are the following:

**Weld thickness** - Thinner welds may occur because less weld reinforcement is applied to the weld joint.

**Welding speed** - Because less weld metal is being applied, the rate of travel along the joint can be faster, which may make it harder to create a uniform weld.

**Slag inclusions** - Some spattered slag can be thrown in front of the weld bead and be trapped or included in the weld, resulting in a weld defect.

**Spatter** - Depending on the electrode, the amount of spatter may be slightly increased with the forehand technique.

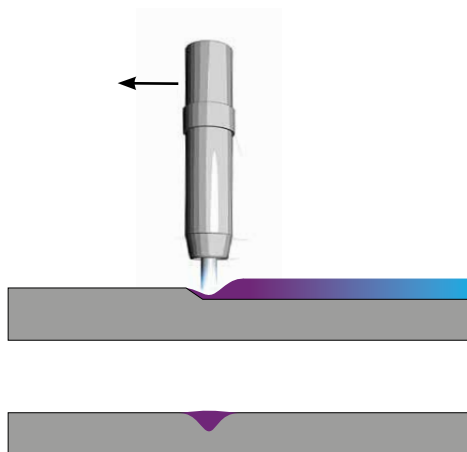

**Advantages of the Perpendicular Technique** The perpendicular welding technique has the following advantages:

**Machine and robotic welding** - The perpendicular gun angle is used on automated welding because there is no need to change the gun angle when the weld changes direction.

**Uniform bead shape** - The weld's penetration and reinforcement are balanced between those of forehand and backhand techniques. Disadvantages of the Perpendicular Technique

**The disadvantages of using the perpendicular welding technique are the following:**

**Limited visibility** - Because the welding gun is directly over the weld, there is limited visibility of the weld unless you lean your head way over to the side.

**Weld spatter** - Because the weld nozzle is directly under the weld in the overhead position, more weld spatter can collect in the nozzle, causing gas flow problems or even shorting the tip to the nozzle.

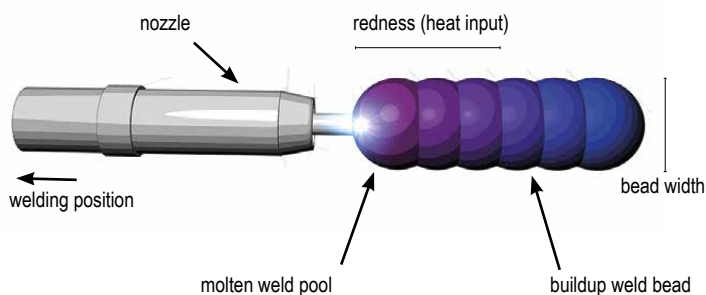

**Advantages of the Backhand Technique** The backhand welding technique has the following advantages:

**Weld bead visibility** - It is easy to see the back of the molten weld pool as you are welding, which makes it easier to control the bead shape.

**Travel speed** - Because of the larger amount of weld metal being applied, the rate of travel may be slower, making it easier to create a uniform weld.

**Depth of fusion** - The arc force and the greater heat from the slower travel rate both increase the depth of weld joint penetration.

**Disadvantages of the Backhand Technique** The disadvantages of the backhand welding technique are the following:

**Weld buildup** - The weld bead may have a convex (raised or rounded) weld face when you use the backhand technique.

**Postweld finishing** - Because of the weld bead shape, more work may be required if the product has to be finished by grinding smooth.

**Joint following** - It is harder to follow the joint because your hand and the FCAW gun are positioned over the joint, and you may wander from the seam.

**Loss of penetration** - An inexperienced welder sometimes directs the wire too far back into the weld pool causing the wire to build up in the face

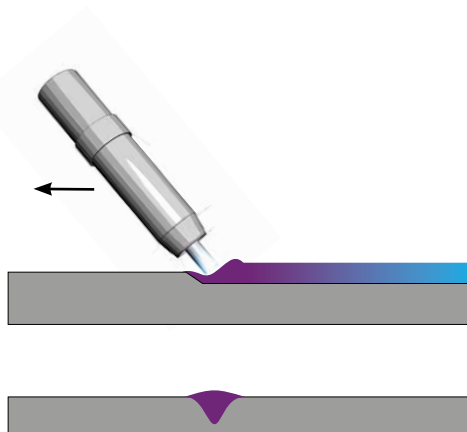

## HORIZONTAL WELDING ANGLES

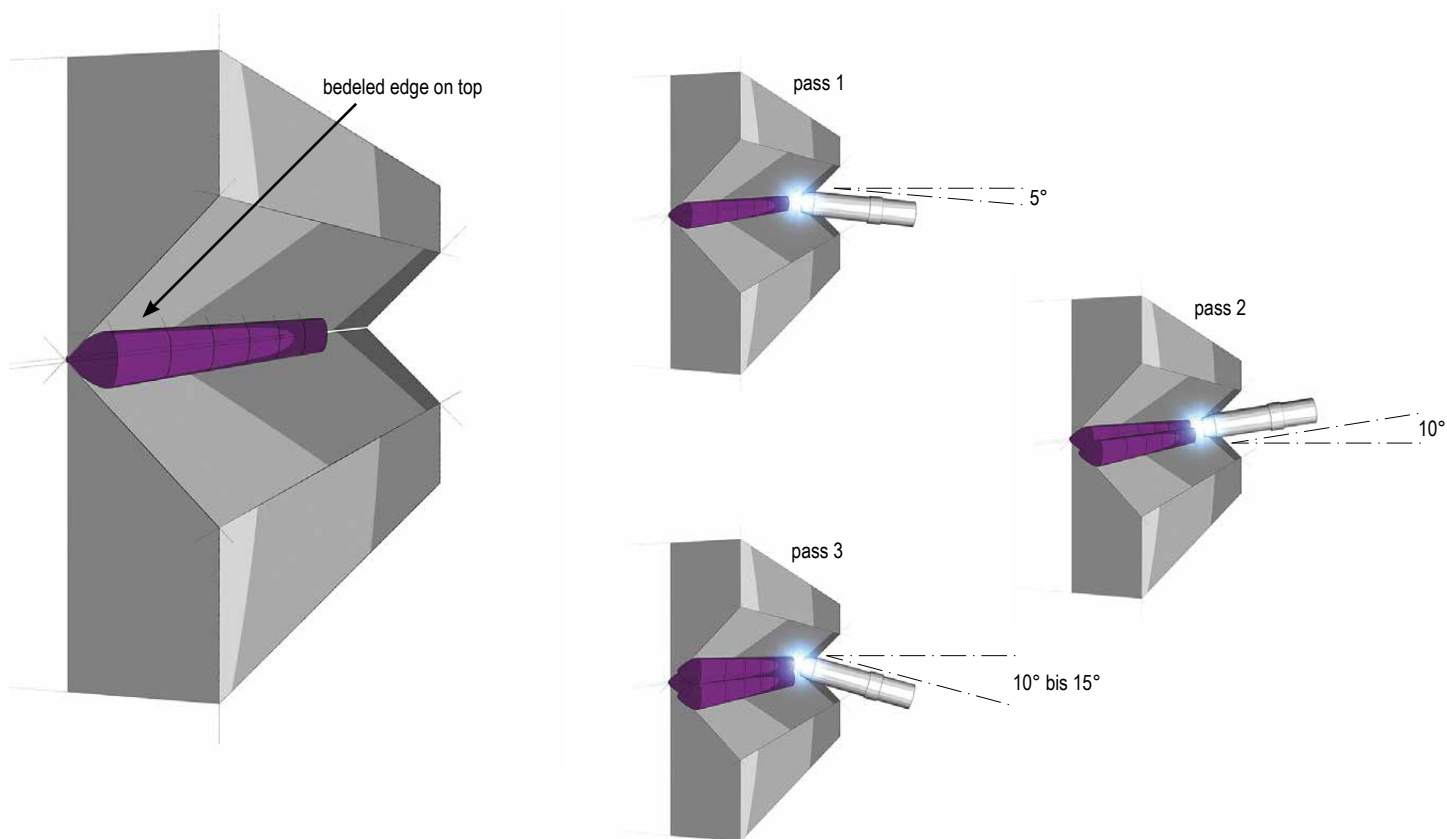

## FILLET WELDING ANGLES

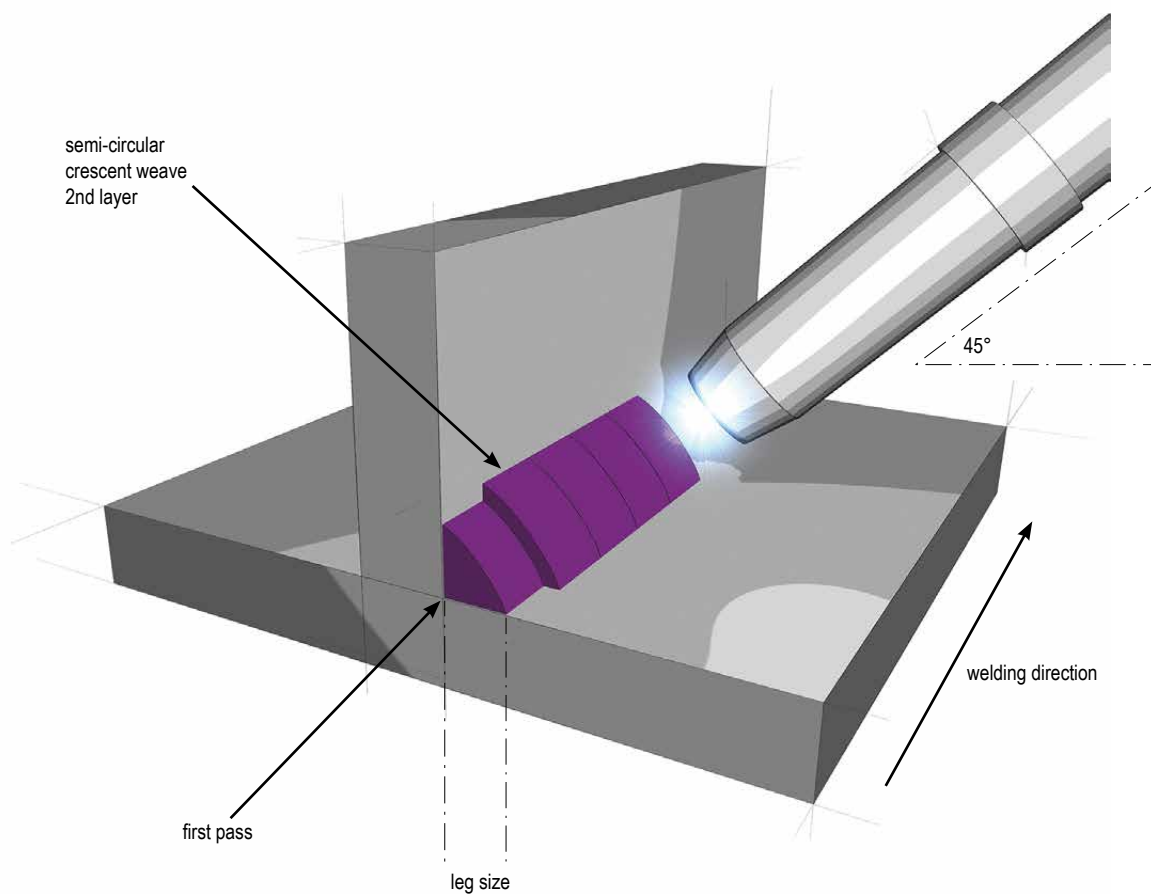

VERTICAL UP / DOWN WELDING ANGLES

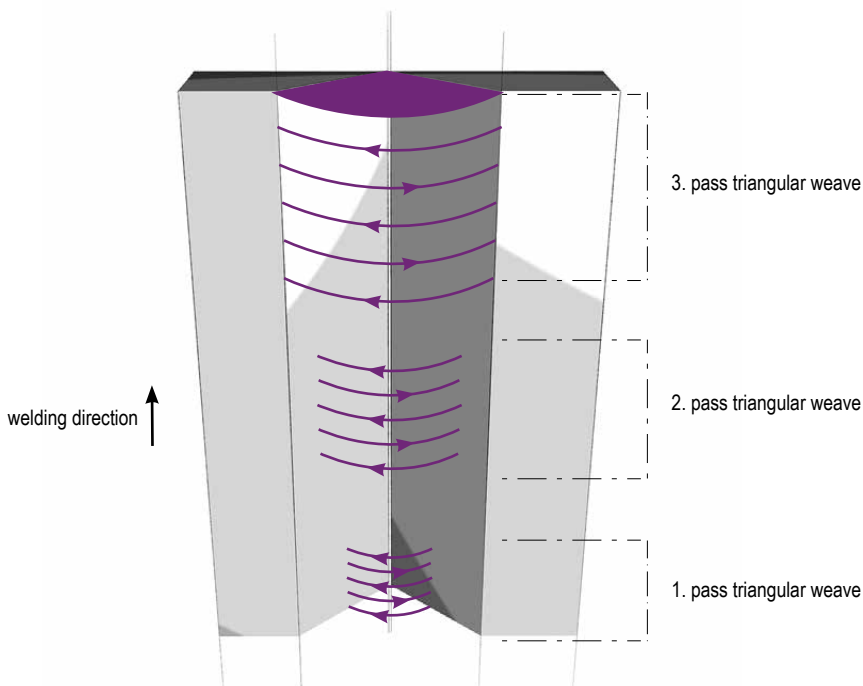
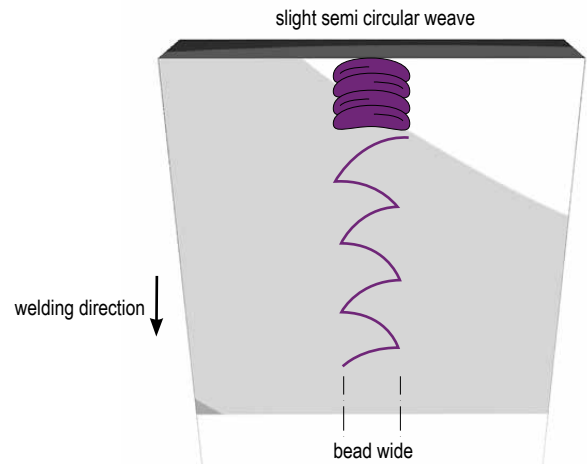
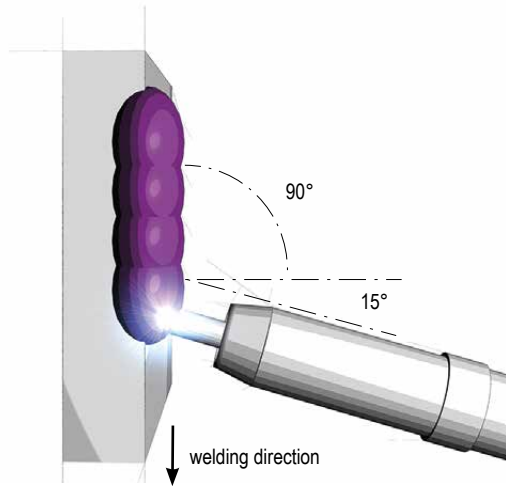
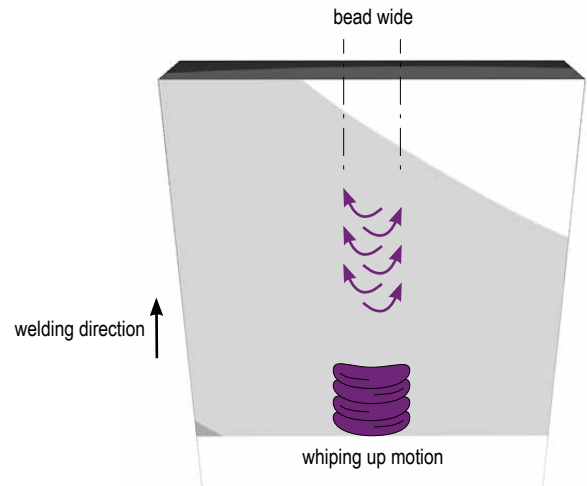
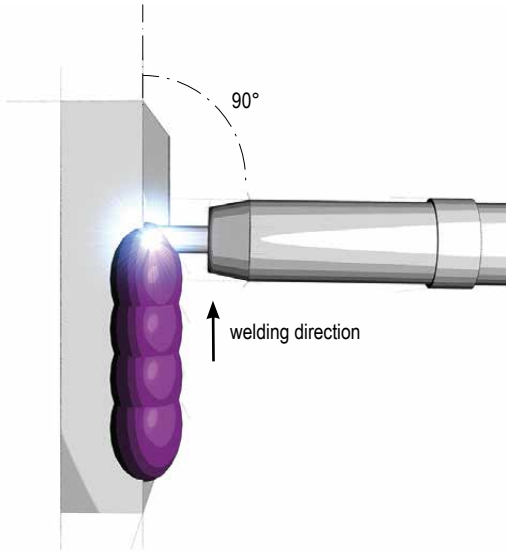

For slag-carrying cored electrodes a pure pendulum movement

### OVERHEAD WELDING ANGLES

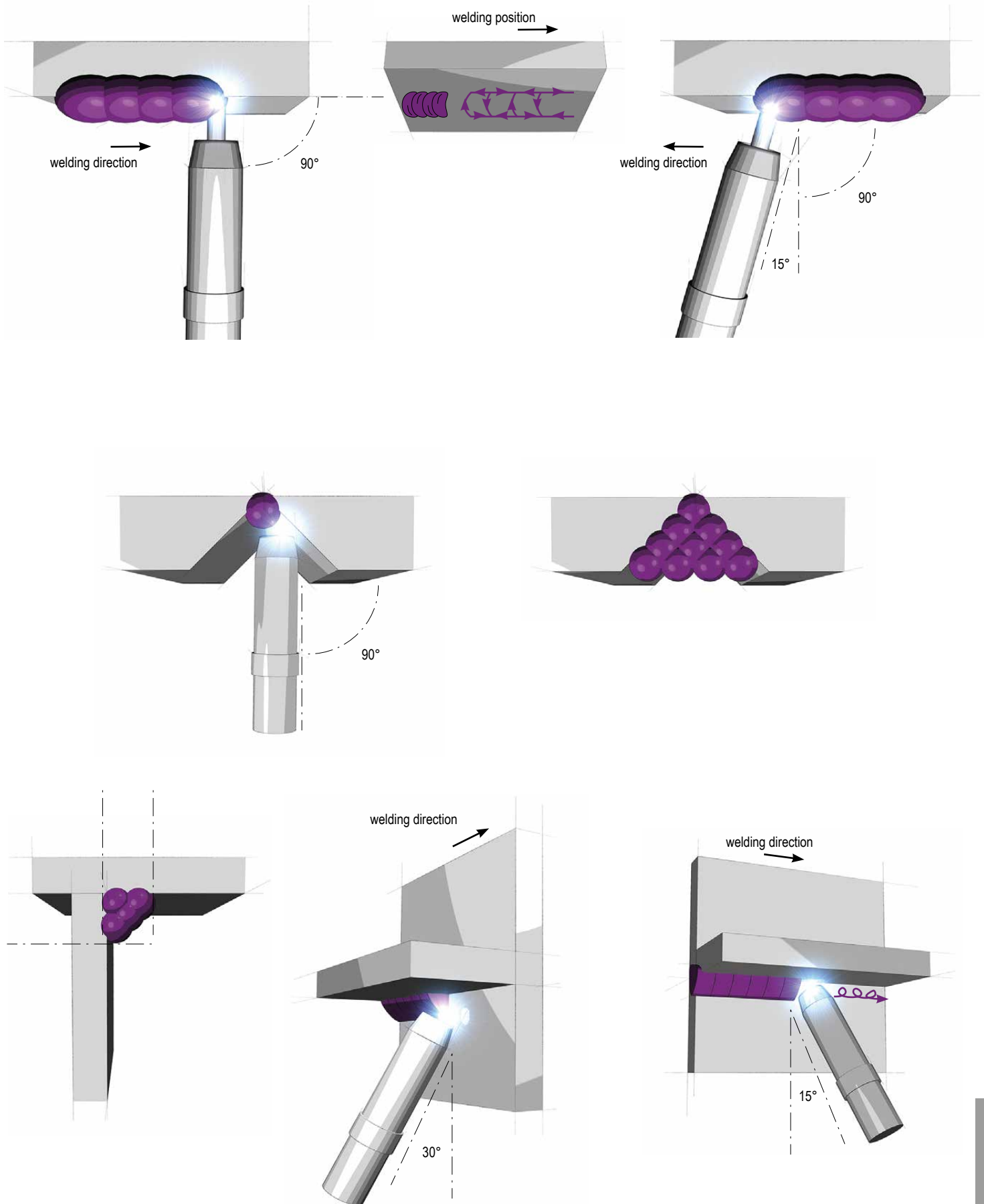



## Deposition Rate

The deposition rate is the rate that weld metal can be deposited by a given electrode or welding wire, expressed in kg per hour. It is based on continuous operation, not allowing time for stops and starts caused by inserting a new electrode, cleaning slag, termination of the weld or other reasons. The deposition rate will increase as the welding current is increased. When using solid or flux cored wires, deposition rate will increase as the electrical stick-out is increased, and the same amperage is maintained. True deposition rates for each welding filler metal, whether it is a coated electrode or a solid or flux cored wire, can only be established by an actual test in which the weldment is weighed before welding and then again after welding, at the end of a measured period of time.

### Approximate deposition rate:

Wfs = Wire feed speed cm/min (inches/min)

**Deposition rate kg/h = Wire weight g/m \* Wfs cm/min \* 0.0006 ISO**

**Deposition rate lbs/h = Wire weight lbs/inch \* Wfs inches/min \* 60 AWS**

### Deposition Efficiency:

Deposition efficiency is the relationship of the weight of the weld metal deposited to the weight of the electrode (or wire) consumed in making a weld. It can be accurately determined only by making a timed test weld, and carefully weighing the weld metal and the electrode or wire, before and after welding. The efficiency can then be calculated by the formula:

**DEPOSITION EFFICIENCY = (Weight of Weld Metal) / (Total weight Electrode used)**

Or

**(Deposition Rate ( kg/h)) / ( Burn-off rate ( kg/h))**

## HINTS ABOUT DEPOSITION EFFICIENCY

GMAW = 90-96 % Solid wire Gas

GMAW = 98-100 % Solid wire SAW

MCAW = 90-96 % Metal cored wire

FCAW = 80-90 % Flux cored wire ( rutil, basic)

SMAW = 55-60 % Covered electrode Stick Electrode

### Deposition Rates Stick Electrode

The different types of electrodes have different deposition rates due to the composition of the coating. The electrodes containing iron powder in the coating have the highest deposition rates. In the United States, the percentage of iron powder in a coating is in the 10 to 50 percent range. This is based on the amount of iron powder in the coating versus the coating weight. This is shown in the formula:

$$\text{iron powder} = (\text{Weight of iron} \times 100) / (\text{Total weight of coating}) \text{ AWS}$$

These percentages are related to the requirements of the American Welding Society (AWS) specifications.

**The European method** of specifying iron powder is based on the weight of deposited weld metal versus the weight of the bare core wire consumed. This is shown as follow

$$\text{iron powder} = (\text{Weight of deposit metal} \times 100) / (\text{weight of bare core wire}) \text{ ISO}$$

Symbol %	Metal recovery %	Type of current
1	<105	AC +DC
2	<105	DC
3	105 <125	AC +DC
4	105 <125	DC
5	125 <160	AC +DC
6	125 <160	DC
7	>160	AC +DC
8	>160	DC

Thus, if the weight of the deposit were double the weight of the core wire, it would indicate a 200 percent deposition efficiency, even though the amount of the iron powder in the coating represented only half of the total deposit. The 30 percent iron powder formula used in the United States would produce a 100 to 110 percent deposition efficiency using the European formula. The 50 percent iron powder electrode figured on United States standards would produce an efficiency of approximately 150 percent using the European formula

### Theoretical deposition rate of the different welding processes

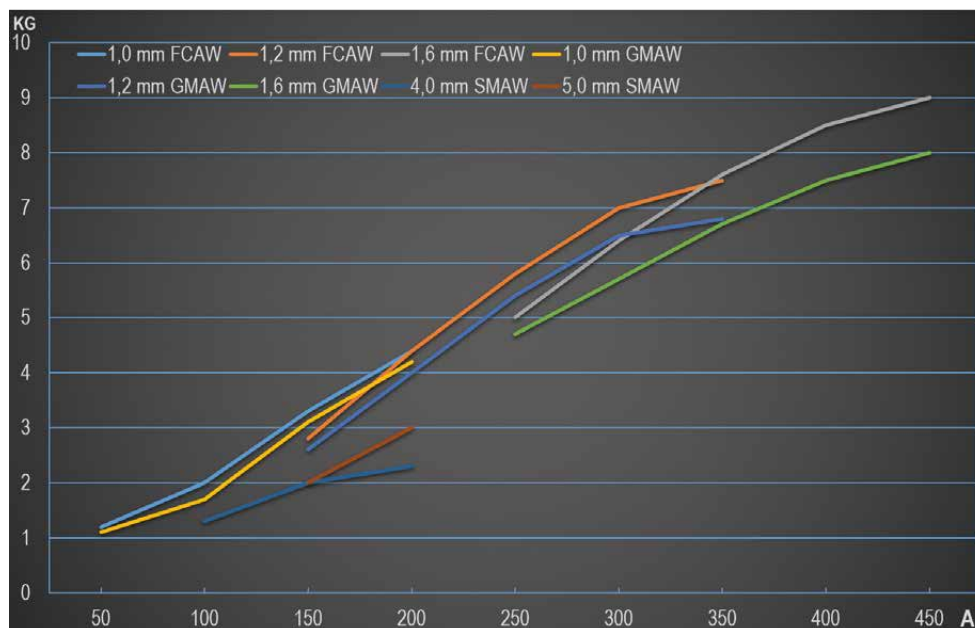

### Joining of metals:

Unlike brazing and soldering, where the base material is not melted (the process is very similar to gluing) , welding is a high temperature process where the base material is melted. Comparable to creating steel in a blast furnace or remelting steel.

Typically, a filler material is melted with the parts to be joined. However, there is also the possibility to work without filler material, e.g. with Laser or TIG.

The high temperature creates a weld pool of molten material that cools and forms the joint, which can be stronger than the base metal. Pressure can also be used to create a weld, either along with the heat or alone.

A shielding gas or powder may also be used to protect the molten and filler metal from contamination or oxidation.

### Typical weld preparations:

#### Butt Joint



A joint between the ends or edges of two parts butted in the area of the joint with or without seam preparation.

#### T Joint



A joint between the end or edge of one part and the face of the other part, the parts forming an angle of more than 5 to 90°, inclusive, with respect to each other in the area of the joint. This can be with or without seam preparation, depending on the thickness of the material.

As a full connection or as a pure fillet weld single or multilayer.

#### Corner Joint



A joint between the ends or edges of two parts that form an angle of more than 30 but less than 135° to each other in the area of the joint.

#### Edge Joint

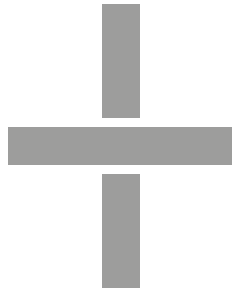

A joint between the edges of two parts that have an angle to each other of 0 to 30° inclusive in the horizontal.

**Cruciform Joint**

A joint where two flat plates or two bars are welded to another flat plate at right angles and on the same axis. Depending on the material thickness with or seam preparation as full connection or fillet weld.

**Lap Joint**

A joint between two overlapping parts that enclose an angle of 0-5° to each other in the area of the weld or welds. As a single-layer or multi-layer fillet weld.

**Based on Penetration**

Partial penetration weld



Full penetration weld

**Weld designation based on accessibility**

Single side weld

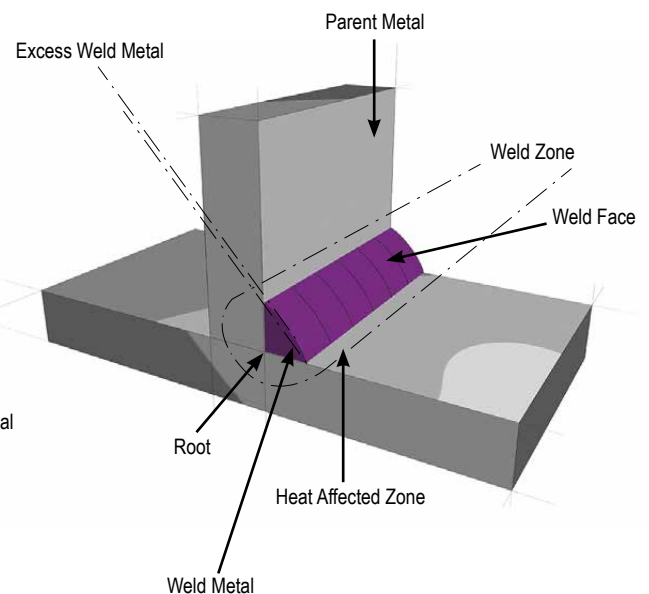
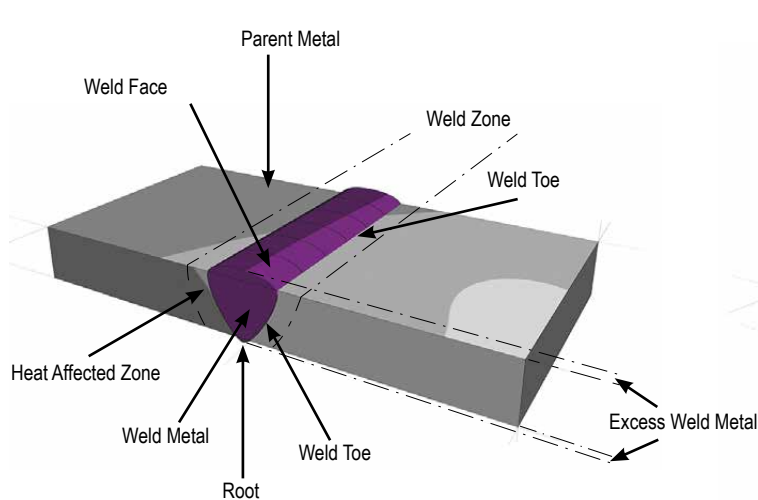

Double side weld

**Features of Completed Welds**

### Parent Metal

Metal to be joined or deposited by welding, brazing or hardfacing.

### Filler Metal

Metal added during welding, brazing or hardfacing.

### Weld Metal

All metal, of the filler metal that was melted off.

### Heat Affected Zone (HAZ)

The part of the base metal that is metallurgically affected by the welding or flame-cutting heat but is not molten.

### Fusion Line

Lowest zone of the first layer. This area places high demands on the welder and can be executed with or bath fuse.

### Weld Root

Lowest zone of the first layer. This area places high demands on the welder and can be executed with or bath fuse.

### Weld Toe

Border between a weld surface and the base metal or between beads. This is a very important feature of a weld seam, since the seam transitions have high stress concentrations and are often initial points for various types of cracks (e.g. fatigue cracks, cold cracks). Here, there are often high requirements for notch-free transitions.

There is the possibility of post-processing by means of TIG smoothing or grinding.

### Excess Weld Metal

Weld metal that lies outside the joint plane of the root or cover layer. This is often defined as to how high it must be or the maximum it may be.

### Run

One layer and one welding bead up to several beads and filling layers



Single-run welding

Multi-layer welding with multiple weld beads weave technique



The layer structure is often specified in regulations (offshore only line beads, no swinging allowed) or is specified by the economic design of the application. Pendulum beads for upwards welding with rutile flux cored electrodes (often used for orbital welding of pipelines).

## SELECTION OF SOME WELDING METHODS / PROCESSES AND THEIR REFERENCE NUMBERS:

Prozess	Reference numbers	US acronym
Arc welding	1	CAW-G /S/T
Metal arc welding	101	
Metal arc welding without gas protection	11	
Manual metal arc welding (metal arc welding with covered electrode); shielded metal arc welding	111	SMAW
Self-shielded tubular-cored arc welding	114	
Submerged arc welding (UP )	12	SAW
Submerged arc welding with one solid wire electrode	121	
Submerged arc welding with strip electrode	122	
Submerged arc welding with multiple solid wire electrode	123	
Submerged arc welding with metallic powder addition	124	
Submerged arc welding with tubular cored electrode	125	
Submerged arc welding with cored strip electrode	126	
Gas-shielded metal arc welding; gas metal arc welding (USA)	13	GMAW
MIG welding with solid wire electrode; gas metal arc welding using inert gas and solid wire electrode	131	GMAW
MIG welding with metal cored electrode; flux cored arc welding	132	
MIG welding with flux cored electrode; gas metal arc welding using inert gas and metal cored wire	133	
MAG welding with solid wire electrode; gas metal arc welding using active gas with solid wire electrode	135	GMAW
MAG welding with flux cored electrode; gas metal arc welding using active gas and flux cored wire	136	FCAW
MIG welding with flux cored electrode; gas metal arc welding using active gas and metal cored wire	138	MCAW
Gas shielded welding with non consumable electrode / Gas tungsten arc welding	14	GTAW
TIG welding with tungsten electrode under inert gas with a solid wire or rod	141	GTAW
TIG welding without filler material / with consumable insert	142	
TIG welding with cored wire or rod	143	
Plasma arc welding	15	PAW
Oxyfuel gas welding (Gas welding)	3	OFW
Oxy-acetylene welding	311	OAW
Oxy-propane welding	312	
Oxy-hydrogen welding	313	OHW
Air acetylene welding	32	AAW
Pressure welding	4	RW
Ultrasonic welding	41	USW
Friction welding	42	FRW
Friction stir welding	43	FSW
Electron Beam welding	51	
Electron beam welding in vacuum	511	EBW
Laser welding; laser beam welding	52	LBW
Other welding processes	7	
Thermit welding	71	
Electroslag welding	72	ESW
Electroslag welding with strip electrode	721	
Electroslag welding with wire electrode	722	
Electrogas welding	73	EGW
Induction welding	74	IW
Cutting and gouging	8	OC
Brazing, soldering and braze welding	9	B (EBBW) ( FLOW) (EXBW)

If you're in the welding industry, then you're constantly surrounded by all sorts of acronyms. Below is a selection of the most commonly used acronyms in our industry.

ABS	American Bureau of Shipping
AC	Alternating current
AISI	American Iron and Steel Institute
AL	Aluminium
AMP	Amperes (measure of current)
ANSI	American National Standard Institute
Ar	Argon (inert shielding gas)
ASM	American Society for Metals
ASME	American Society of Mechanical Engineering
ASTM	American Society for Testing and Materials
AWS	American Welding Society
BS	British Standard
BV	Bureau Veritas (French classification institute)
BZ	Brazing
CE	Conformité Européenne (European Conformity)
CSA	Canadian Standards Association
CMTR	Certified Material Test Report
CO <sub>2</sub>	Carbon Dioxide
COC	Certificate of Conformance
CTWD	Contact Tip to Work Distance (Stick out)
CWE	Certified Welding Educator
CWI	Certified Welding Inspector
CWB	Canadian Welding Bureau
DC	Direct Current
DCEN	Direct Current Electrode Negative polarity (DC-)
DCEP	Direct Current Electrode Positive polarity (DC+)
DNV	Det Norske Veritas (Norwegian classification institute)
EBW	Electron Beam Welding
EN	Euro Norm (The European Community for standardization has developed a nomenclature in welding)
ESO	Electrical Stick Out
ESW	Electroslag Welding Elektroschlackeschweißen
FCAW	Flux Cored Arc Welding
FCAW-GS	Flux Cored Arc Welding – Gas Shielded
FCAW-SS	Flux Cored Arc Welding – Self Shielded
Ft-Lb	Foot Pounds = 1,355 817 948 331 400 4 J (Joule)
FW	Friction Welding



GTAW	Gas Tungsten Arc Welding
GMAW	Gas Metal Arc Welding
GMAW-P	Gas Metal Arc Welding Pulse (transfer)
In	Inches = 2,54 cm
IPT	Inter Pass Temperature
LR	Lloyds Register of Shipping (British classification Society)
MAG	Metal Active Gas (see also GMAW)
MIG	Metal Inert Gas
mm	Millimeter
MPa	Mega Pascal
MT	Magnetic Particle Testing
MTR	Material Test Report
NDT	Non Destructive Testing
NS	Norwegian Standards Association
NSFI	Norwegian Research Institute for Ships
O <sub>2</sub>	Oxygen
OFW	Oxyfuel Welding
PAW	Plasma Arc Welding
PPM	Parts Per Million
PQR	Procedure Qualification Record
PWHT	Post Weld Heat Treatment
RT	Radiographic Testing (X-ray)
QCM	Quality Control Manager
SAW	Submerged Arc Welding
SMAW	Shielded Metal Arc Welding (stick welding)
TIG	Tungsten Inert Gas (See GTAW)
TS	Travel Speed
UT	Ultrasonic Testing
UP	Unter Pulver Schweißen (SAW)
V	Volts or Voltage
VT	Visual Testing
WFS	Wire Feed Speed
WPS	Welding Procedure Specification

Netherlands:

Certilas Nederland BV  
Gloxinialaan 2  
6851 TG Huissen  
info@certilas.nl

Germany:

Certilas GmbH  
Philipp-Mayer-Strasse 4  
DE 67304 Eisenberg / Pfalz  
Mail.GmbH@certilas.com

France:

Certilas SAS  
10 rue Jean Lhomer  
78710 Rosny sur Seine  
France@certilas.com

[www.certilas.com](http://www.certilas.com)

